

Operation Manual

Smart-UPS[™] C Uninterruptible Power Supply

1000/1500 VA
Tower / Rack-Mount 2U
120 Vac/230 Vac

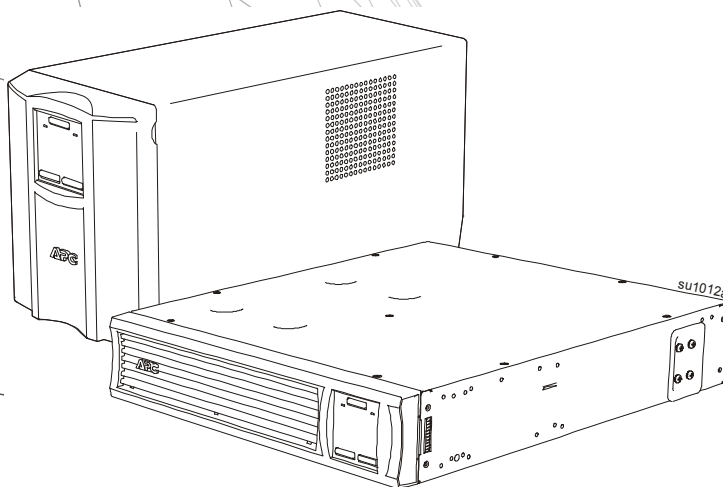

Important Safety Messages

SAVE THESE INSTRUCTIONS - This manual contains important instructions that should be followed during installation and maintenance of the UPS and batteries.

Read the instructions carefully. Become familiar with the device before trying to install, operate, service or maintain it. The following special messages may appear throughout this document or on the equipment to warn of potential hazards or to call attention to information that clarifies or simplifies a procedure.



The addition of this symbol to a Danger or Warning product safety label indicates that an electrical hazard exists that will result in personal injury if the instructions are not followed.



This is the safety alert symbol. It is used to alert you to potential personal injury hazards. Obey all safety messages that follow this symbol to avoid possible injury or death.

DANGER

DANGER indicates a hazardous situation which, if not avoided, will result in death or serious injury.

WARNING

WARNING indicates a hazardous situation which, if not avoided, could result in death or serious injury.

CAUTION

CAUTION indicates a hazardous situation which, if not avoided, could result in minor or moderate injury.

NOTICE

NOTICE is used to address practices not related to physical injury.

Product Handling Guidelines



<18 kg
<40 lb



18-32 kg
40-70 lb



32-55 kg
70-120 lb



>55 kg
>120 lb



Safety and General Information

**Inspect the package contents upon receipt.
Notify the carrier and dealer if there is any damage.**

- Adhere to all national and local electrical codes.
- All wiring must be performed by a qualified electrician.
- **Changes and modifications to this unit not expressly approved by APC by Schneider Electric could void the warranty.**
- This UPS is intended for indoor use only.
- Do not operate this unit in direct sunlight, in contact with fluids, or where there is excessive dust or humidity.
- Be sure the air vents on the UPS are not blocked. Allow adequate space for proper ventilation.
- For a UPS with a factory installed power cord, connect the UPS power cable directly to a wall outlet. Do not use surge protectors or extension cords.
- The equipment is heavy. Always practice safe lifting techniques adequate for the weight of the equipment.

Deenergizing safety

The UPS contains internal batteries and may present a shock hazard even when disconnected from the branch circuit (mains). Before installing or servicing the equipment check that the:

- Input circuit breaker is in the **OFF** position.
- Internal UPS batteries are removed.

Electrical safety

- Use tools with insulated handles.
- Do not handle any metallic connector before power has been disconnected.
- For models with a hardwired input, the connection to the branch circuit (mains) must be performed by a qualified electrician.
- 230 V models only: In order to maintain compliance with the EMC directive for products sold in Europe, output cords attached to the UPS must not exceed 10 meters in length.
- The protective earth conductor for the UPS carries the leakage current from the load devices (computer equipment). An insulated ground conductor is to be installed as part of the branch circuit that supplies the UPS. The conductor must have the same size and insulation material as the grounded and ungrounded branch circuit supply conductors. The conductor will typically be green, with or without a yellow stripe.
- Leakage current for a pluggable, Type A UPS may exceed 3.5 mA when a separate ground terminal is used.
- The UPS input ground conductor must be properly bonded to protective earth at the service panel.
- If the UPS input power is supplied by a separately derived system, the ground conductor must be properly bonded at the supply transformer or motor generator set.

Hardwire safety

- Check that all branch circuit (mains) and low voltage (control) circuits are deenergized, and locked out before installing cables or making connections, whether in the junction box or to the UPS.
- Wiring by a qualified electrician is required.
- Check national and local codes before wiring.
- Strain relief is required for all hardwiring (supplied with select products). Snap in type strain reliefs are recommended.
- All openings that allow access to UPS hardwire terminals must be covered. Failure to do so may result in personal injury or equipment damage.
- Select wire size and connectors according to national and local codes.

Battery safety

- When replacing batteries, replace with the same number and type.
- The batteries typically last for two to five years. Environmental factors impact battery life. Elevated ambient temperatures, poor quality utility power, and frequent short duration discharges will shorten battery life. The battery should be replaced before end of life.
- Replace the batteries immediately when the unit indicates battery replacement is necessary, or when the batteries reach end of life, whichever occurs first.
- APC by Schneider Electric uses sealed lead acid batteries. Under normal use and handling, there is no contact with the internal components of the battery. Over charging, over heating or other misuse of batteries can result in a discharge of battery electrolyte. Released electrolyte is toxic and may be harmful to the skin and eyes.
- CAUTION: Before installing or replacing the batteries, remove jewelry such as wristwatches and rings. High short circuit current through conductive materials could cause severe burns.
- CAUTION: Do not dispose of batteries in a fire. The batteries may explode.
- CAUTION: Do not open or mutilate batteries. Released material is harmful to the skin and eyes and may be toxic.

General information

- The model and serial numbers are located on a small, rear panel label. For some models, an additional label is located on the chassis under the front bezel.
- Always recycle used batteries.
- Recycle the package materials or save them for reuse.

FCC Class A radio frequency warning

This equipment has been tested and found to comply with the limits for a Class A digital device, pursuant to part 15 of the FCC Rules. These limits are intended to provide reasonable protection against harmful interference when the equipment is operated in a commercial environment. This equipment generates, uses, and can radiate radio frequency energy and, if not installed and used in accordance with the instruction manual, may cause harmful interference to radio communications. Operation of this equipment in a residential area is likely to cause harmful interference in which case the user will be required to correct the interference at his own expense.

WARNING: This is a category C2 UPS product. In a residential environment, this product may cause radio interference, in which case the user may be required to take additional measures.

SMC1000-2UC and SMC1000I-2UC Rack-Mount

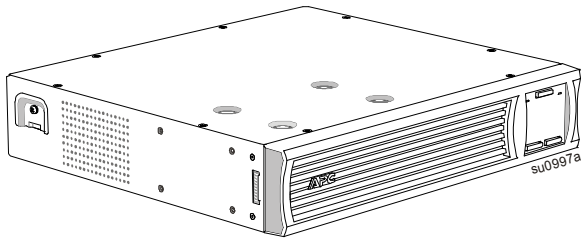

SMC1000C, SMC1000IC, SMC1500C and SMC1500IC Tower

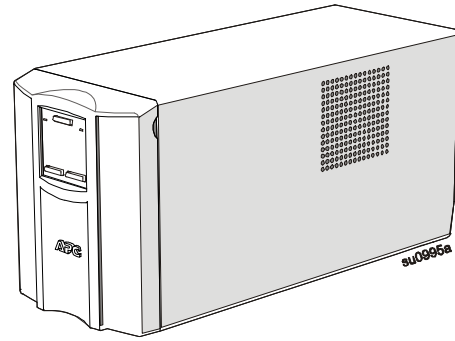

SMC1500-2UC and SMC1500I-2UC Rack-Mount

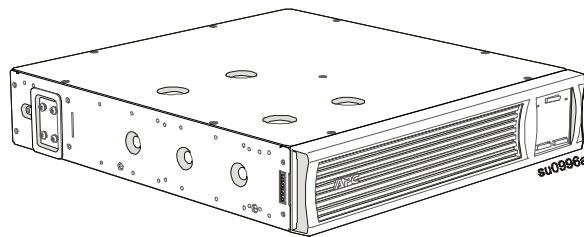

Specifications

For additional specifications, refer to the APC Web site at www.apc.com.

Environmental specifications

Temperature	Operating	0° to 40° C (32° to 104° F)
	Storage	-15° to 45° C (5° to 113° F) charge UPS battery every six months
Maximum Elevation	Operating	3,000 m (10,000 ft)
	Storage	15,000 m (50,000 ft)
Humidity	0% to 95% relative humidity, non-condensing	

Product Overview

Front panel features

SMC1000-2UC and SMC1000I-2UC Rack-Mount

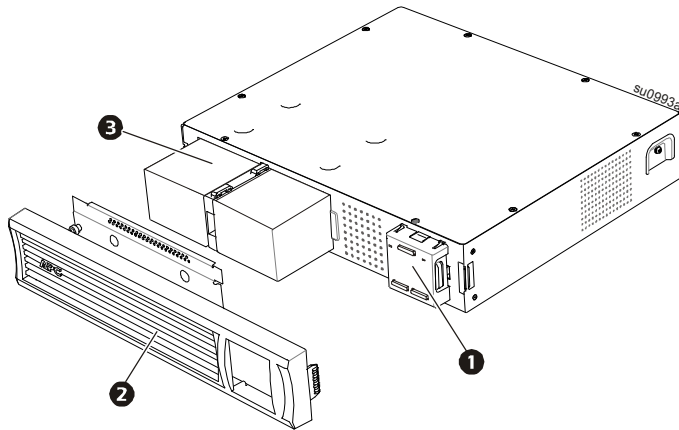

SMC1000C, SMC1000IC, SMC1500C, and SMC1500ICTower

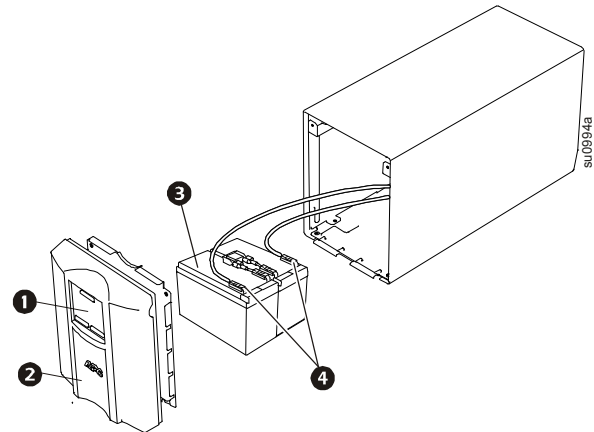

SMC1500-2UC and SMC1500I-2UC Rack-Mount

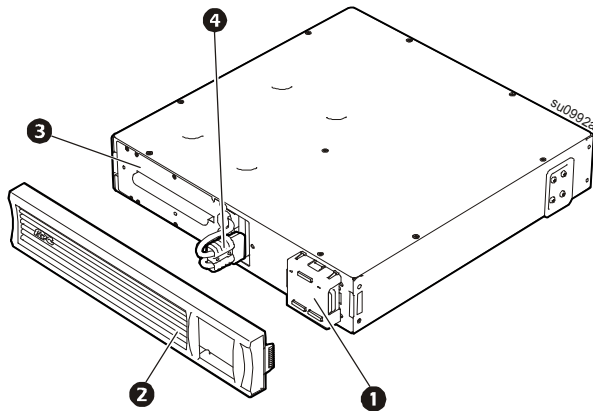

- 1 Display (more information below)
- 2 Bezel
- 3 Battery
- 4 Internal battery connector

Rear panel features

- 1 APC™ SmartConnect port
- 2 Serial port
- 3 USB port
- 4 Chassis ground screw
- 5 Circuit breaker/overload protection
- 6 Outlets
- 7 Battery connector

SMC1000-2UC Rack-Mount

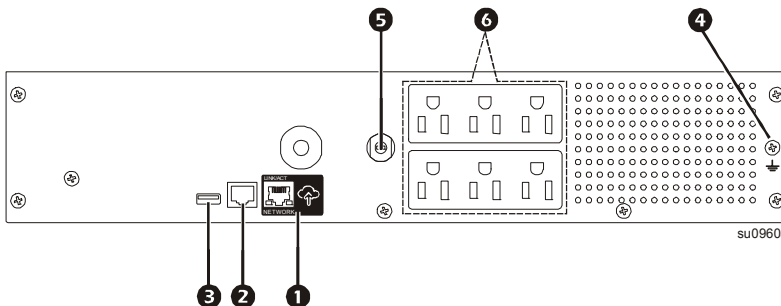

SMC1500-2UC Rack-Mount

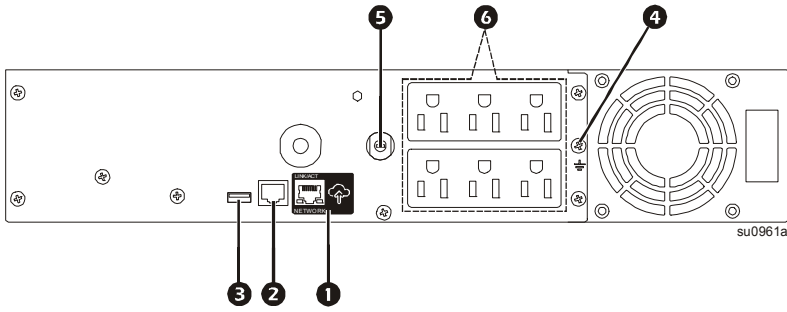

SMC1000I-2UC Rack-Mount

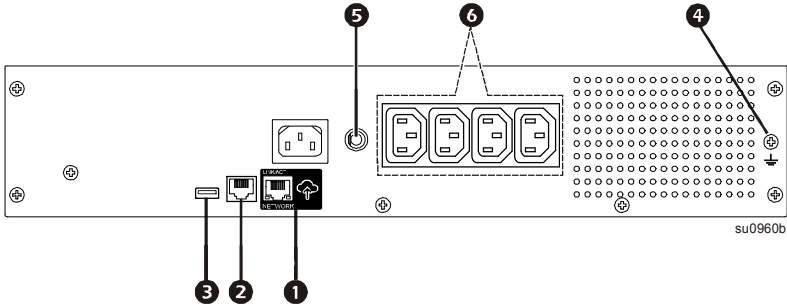

SMC1500I-2UC Rack-Mount

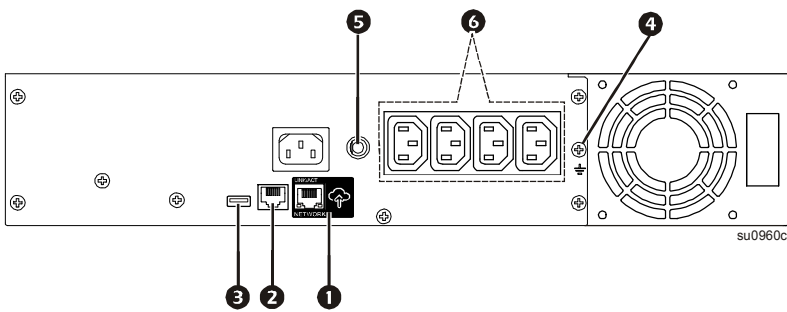

SMC1000C and SMC1500C Tower

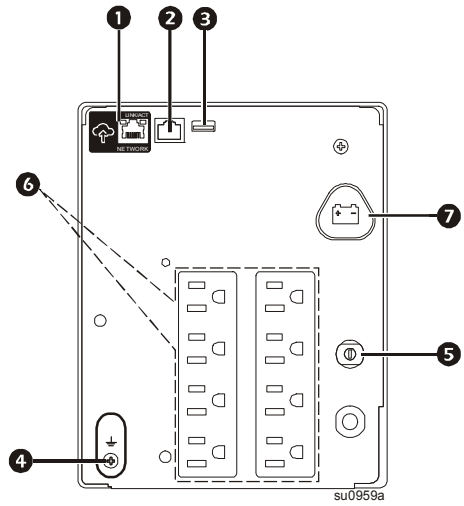

SMC1000IC and SMC1500IC Tower

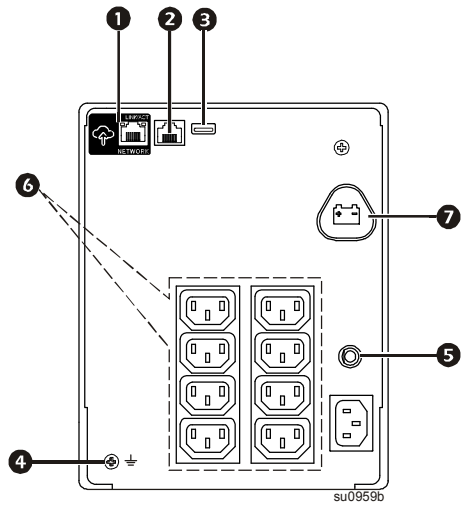

Dimensions and weights

Tower Models

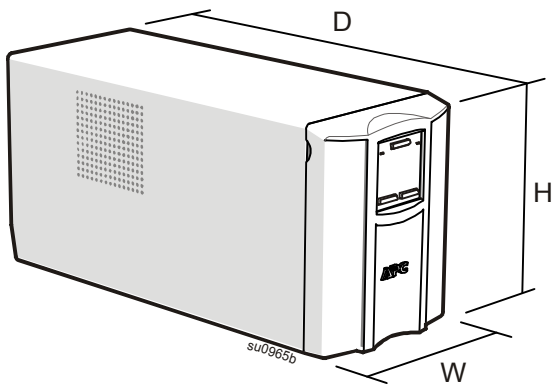

Rack-Mount Models

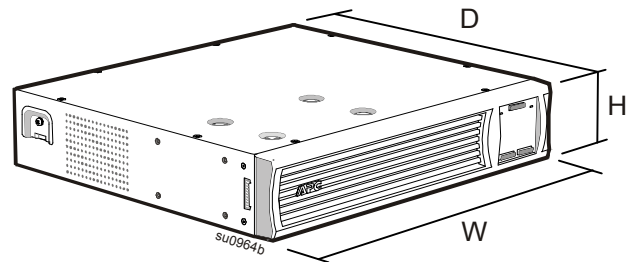

Model	Dimensions (in/mm) H x W x D	Weight (lb / kg)
SMC1000C, SMC1000IC	8.6 x 6.7 x 17.3 in (219 x 171 x 439 mm)	37.5 / 17
SMC1500C, SMC1500IC		44.3 / 20.1
SMC1000-2UC, SMC1000I-2UC	3.4 x 17 x 16 in (86 x 432 x 409 mm)	39.3 / 17.8
SMC1500-2UC, SMC1500I-2UC	3.4 x 17 x 18.8 in (86 x 432 x 477 mm)	55.8 / 25.3

Installation

For UPS installation information, refer to the Installation Guide included with the UPS.

The Installation Guide is also available on the Documentation CD included with the UPS and on the APC by Schneider Electric Web site, www.apc.com.

Placement

The UPS is intended for IT environments. Avoid placement where there is excessive dust, temperature and humidity. Note that temperature in excess 25°C may have an adverse effect on battery and UPS life. All vents on the side or rear of the UPS should be free of obstructions.

The UPS is heavy. For rack-mount units it is suggested that the batteries be removed to facilitate easier installation. The UPS should be placed near the bottom of the rack.

Connect to equipment and utilities

Note: The UPS will charge to 90% capacity in the first three hours of normal operation.



Do not expect full battery runtime capability during this initial charge period.

⚠ CAUTION

RISK OF DAMAGE TO EQUIPMENT OR PERSONNEL

- Adhere to all local and national electrical codes.
- Wiring should be performed by qualified electrician.
- Always connect the UPS to a grounded outlet.

Failure to follow these instructions can result in injury.

1. Connect equipment to the outlets in the rear of the UPS.
2. Connect the APC SmartConnect port  to your nearest network switch using the cable provided.
3. Connect the UPS input to AC power.
4. Press the main power button  on the UPS display to turn on the UPS output.
Note: The On-line LED will light green when the output is on.
5. Log onto www.smartconnect.apc.com or scan the QR code to launch the registration process. The website includes instructions to setup your online account, activate your warranty and begin managing your UPS remotely.

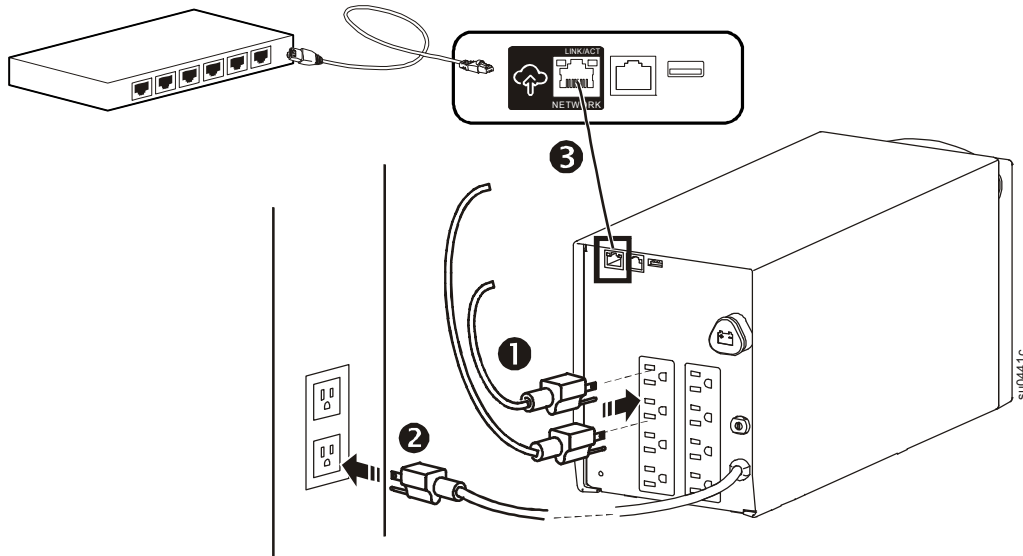

Note: By connecting this product to the Internet using the APC SmartConnect port, you are agreeing to APC SmartConnect Terms of Use, as found at smartconnect.apc.com. Schneider Electric Data Privacy Policy can also be found at smartconnect.apc.com.

Status Indicators

Display panel features

1000/1500 VA 120 Vac

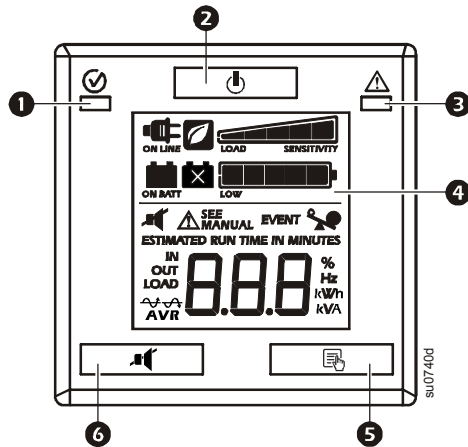

1000/1500 VA 230 Vac

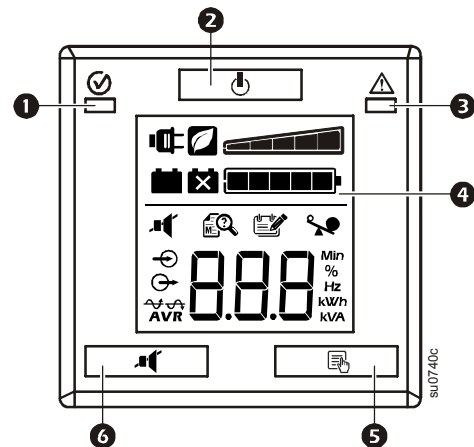

















- ① On Line/On Battery LED
- ② POWER ON/OFF button
- ③ Site Wiring Fault/System Error LED
- ④ Display interface
- ⑤ MENU button
- ⑥ MUTE/ENTER button

Note: Refer to “Display Menu” section on page 11 in this manual for a detailed description of the front panel buttons and icons.





Status	LED	Audible Indicator On	Audible Indicator Terminates
Power On The UPS is supplying AC power to connected equipment.	The On Line/On Battery LED illuminates green.	None	N/A
On Battery The UPS is supplying battery power from the internal battery.	The On Line/On Battery LED illuminates amber.	The UPS beeps 4 times every 30 seconds.	The beeping stops when AC power is restored or the MUTE button is pressed for two seconds.
System Error Detected The UPS detects an internal system error. Refer to “System Errors and Message Codes” .	System Error LED illuminates red.	Constant tone (for severe errors only)	The alarm stops when the POWER ON/OFF button is pressed for two seconds. This creates a System Error Reset .



Display icons

120 Vac	230 Vac	Description
 ON LINE		On Line: The UPS is supplying conditioned AC power to connected equipment.
		Green mode: The UPS is operating at the most efficient level by bypassing unused AVR components while acceptable AC voltage is present. The UPS will enter and exit Green mode automatically and will not compromise power protection.
		Load Capacity: The load capacity percentage is indicated by the number of load bar sections illuminated. Each bar represents 20% of the load capacity.
ESTIMATED RUN TIME IN MINUTES	Min	Estimated Run Time / Min: This indicates the battery runtime minutes that remain if the UPS switches to battery power.
		Battery Charge: The battery charge level is indicated by the number of bar sections illuminated. When all five blocks are illuminated, the battery is fully charged. Each bar represents 20% of the battery charge capacity.

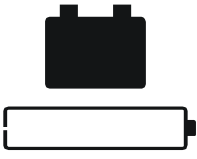
120 Vac	230 Vac	Description
		Overload: The equipment connected to the UPS is drawing more power than the UPS rating allows.
EVENT		Event: The event counter indicates the number of events that occurred to cause the UPS to switch to battery operation.
IN OUT LOAD		In: Input voltage. Out: Output voltage. Load: Output power.
 SEE MANUAL		System Error Detected: An internal system error has occurred. The error number will illuminate on the display. Refer to “ <i>System Errors and Message Codes</i> ” section on page 15.
		Automatic Voltage Regulation (AVR): The UPS has an AVR boost feature that automatically compensates for low or high levels of input voltage without using battery power.  When illuminated, the UPS is compensating for low input voltage.  When illuminated, the UPS is compensating for high input voltage.
		Mute: An illuminated line through the icon indicates that the audible alarm is disabled.
		Battery Error Detected: The icon will flash to indicate that the battery is disconnected. When the icon remains continuously illuminated the UPS did not pass a Self-Test or the battery is near the end of its service life and must be replaced. Refer to “ <i>System Errors and Message Codes</i> ” section on page 15.
		On Battery: The UPS is supplying battery backup power to the connected equipment.

LCD status indicators

Status	LCD Icon	Audible Alarms	Audible Alarm Terminates
On Battery The UPS is supplying battery power to the connected equipment.		Beeps 4 times every 30 seconds.	The beeping stops when AC power is restored or the UPS is turned off.
AC Power Overload An overload condition has occurred while the UPS is operating on AC power.		Constant tone	The alarm stops when nonessential equipment is disconnected from the outlets or the UPS is turned off
Battery Power Overload An overload condition has occurred while the UPS is operating on battery power.		Constant tone	The alarm stops when nonessential equipment is disconnected from the outlets or the UPS is turned off.
Low Battery The UPS is supplying battery power to the connected equipment and the battery is near a total discharge state.		Continuous beeping	The beeping stops when AC power is restored or the UPS is turned off.
Battery Error Detected The UPS is operating on AC power. The battery does not provide expected backup.		The UPS will beep twice to indicate the battery is disconnected. The UPS will beep continuously for one minute every five hours to indicate that the battery must be replaced.	Verify that the battery is securely connected. The battery is nearing the end of its service life and must be replaced.





Status	LCD Icon	Audible Alarms	Audible Alarm Terminates
System Error Detected The UPS has experienced an internal error.	120 Vac models  230 Vac models 	N/A	Identify the error message on the display and refer to the table of codes under "System Errors and Message Codes" section on page 15.

Display Menu



The main part of the display will show different parameters of the UPS. Pressing the menu button  will toggle through the various menus programmed for Output Voltage, Runtime, Input Voltage, SmartConnect Status, etc.

Feature Reference Guide

Normal mode



Function	Button	Timing (seconds)	UPS State	Description
Power				
Power On		0.2	Off	Press the POWER ON/OFF button to turn the UPS output on. The UPS will operate on AC power. If AC power is not available the UPS will operate on battery power.
Power Off		5	On	Press the POWER ON/OFF button to turn the output off using shutdown delays. To turn the output off immediately press and hold the POWER ON/OFF button for 5 seconds.
Display				
Menu Button		0.2	On	The Menu button will advance the display to the next data item. If the display is darkened to save energy, pressing the Menu button will illuminate the display.
Mute				
Enable/Disable		2	On	Enable or disable the audible alarms. The Mute icon will illuminate and the UPS will beep once.
Error Reset		2	Error	After an error has been identified, press the POWER ON/OFF button to remove the visual indication and return to standby status.





Configuration mode



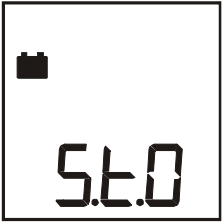
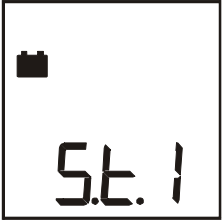
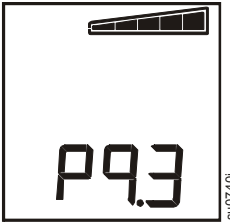
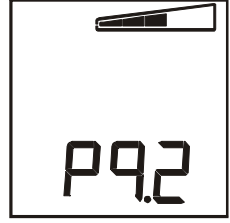
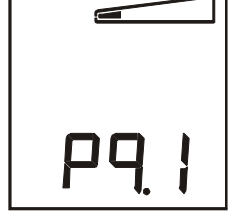

Configuration mode provides the ability to adjust UPS parameters and initiate control actions. To enter configuration mode hold the MUTE  and MENU  buttons together for 2 seconds until the system emits a short beep and the display will flash to indicate the UPS has entered Configuration Mode.

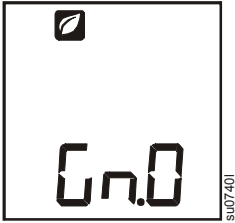
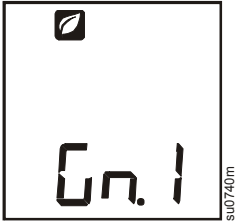
When in Configuration Mode, the MENU button cycles the display through the available options. The MUTE button toggles the configuration settings for that option.

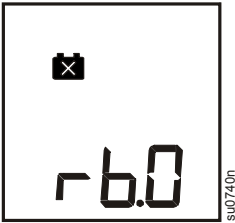
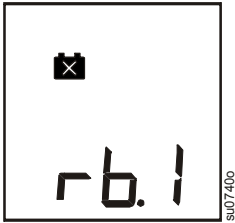
Note: When the UPS detects 20 seconds of no activity in Configuration Mode, or when the MUTE and MENU buttons are pressed together for 2 seconds until the system emits a short beep, the UPS returns to Normal mode.

Function	Options	Description
Firmware Upgrade	<ul style="list-style-type: none"> UP.0 UP.0 = firmware valid and different from current running firmware  UP.1 UP.1 = confirm the firmware update  UPd UPd = firmware update in progress  	<p>This mode only appears when firmware is stored in memory, and different from the current firmware running.</p> <p>UP.0 indicates new firmware is available and different from current firmware, but will not install until instructed by user.</p> <p>Pressing MUTE instructs the UPS to install new firmware, and changes the display to UP.1.</p> <p>UP.1 indicates system is ready for firmware installation.</p> <p>Press MENU to install the firmware and exit Configuration Mode; or press MUTE to revert to UP.0 (canceling firmware installation).</p>
Self-Test	<ul style="list-style-type: none"> 0: Default Setting  1: Begin Self-Test  	<p>Default setting St.0, indicates that a Self Test has not been requested</p> <p>Pressing MUTE requests a Self Test and changes display to St.1.</p> <p>Press MENU to begin Self Test and exit Configuration Mode, or MUTE to revert to St.0 (canceling Self test).</p> <p>Note: Self tests operate only when the output is on.</p>
Power Quality	<ul style="list-style-type: none"> Good  Fair  Poor  	<p>Select the Sensitivity range depending on the desired quality of output AC power:</p> <ul style="list-style-type: none"> Pq.3: (Default) Good - If selected, the unit will go on battery power more often to provide the cleanest power supply to the connected equipment. Use this setting when the input power is normally good as it provides the cleanest power supply to the connected load. Pq.2 - Fair should be selected if the unit is operating on battery too often on the high setting. It makes the unit less sensitive to disturbances in input power. Use this setting when the line input has frequent variations. Pq.1 - If Poor is selected, the UPS will tolerate more fluctuations in power and will go on battery power less often. <p>The unit ships from the factory at the Good setting.</p>

Function	Options	Description
Output Voltage Setting	<ul style="list-style-type: none"> • for 120V models: 110 -> 120 -> 127 • for 230V models: 220 -> 230 -> 240 	Select the output voltage (not available on some models)
LCD Energy Save Mode	<ul style="list-style-type: none"> • dP.0 = disable • dP.1 = enable 	<p>dP.1 - Enabled (Default) - When enabled the LCD will automatically dim after 60 seconds of no activity</p> <p>dP.0 - Disabled - The display will stay illuminated indefinitely.</p>
Communication Protocol	<ul style="list-style-type: none"> • cP.0 = disable • cP.1 = enable 	Enables / disables the Modbus communication protocol. cP.1 (enabled) is the default.
Green Mode Enable	<ul style="list-style-type: none"> • 0: Disable  <ul style="list-style-type: none"> • 1: Enable 	When Green Mode is enabled the UPS is operating at the most efficient level by bypassing unused AVR components while acceptable AC voltage is present. The UPS will enter and exit Green mode automatically while Enabled. Enabled is the default.
SmartConnect remote commands	<ul style="list-style-type: none"> • rc.0: remote control disable • rc.1: remote control enable 	When enabled, it allows SmartConnect to send commands and configuration to the UPS. rc.0, disabled, is the default.
Battery Replaced	<ul style="list-style-type: none"> • rb.0: No battery replacement  <ul style="list-style-type: none"> • rb.1: Battery replaced 	<p>rb.0 - Did not replace battery (default)</p> <p>rb.1 - Battery has been replaced</p> <p>Select rb.1 to indicate that the battery has been replaced, this will reset the constants for the battery runtime calibration to the default for a new battery.</p>

Function	Options	Description
SmartConnect Product Key	cod	<p>Displays the 14-character SmartConnect Product Key in 4 parts each time Mute is pressed.</p> <p>To see the characters, press MENU to toggle through the groups. The groups are displayed with decimal point movement to ease knowing which part of the code is being displayed.</p> <p>Example: Cod -> 123 ->  -> 4.56 ->  -> 78.9 ->  -> 0.1.2 ->  -> 34</p>

Troubleshooting

Problem and Possible Cause	Solution
The UPS will not turn on or there is no output.	
The unit has not been turned on.	Press the ON button once to turn on the UPS.
The UPS is not connected to AC power.	Be sure the power cable is securely connected to the unit and to the AC power supply.
The input circuit breaker has tripped.	Reduce the load on the UPS. Disconnect nonessential equipment and reset the circuit breaker.
The unit shows very low or no input AC voltage.	Check the AC power supply to the UPS by plugging in a table lamp. If the light is very dim, check the AC voltage.
The battery connector plug is not securely connected.	Be sure that all battery connections are secure.
There is an internal UPS error.	Do not attempt to use the UPS. Contact the Customer Care Center immediately.
The UPS is operating on battery, while connected to input AC power.	
The input circuit breaker has tripped.	Reduce the load on the UPS. Disconnect nonessential equipment and reset the circuit breaker.
There is very high, very low, or distorted input line voltage.	Move the UPS to a different outlet on a different circuit. Test the input voltage with the AC voltage display. If acceptable to the connected equipment, reduce the UPS sensitivity.
UPS is emitting intermittent beeps.	
The UPS is operating normally.	None. The UPS is protecting the connected equipment.
UPS does not provide expected backup time.	
The UPS battery is weak due to a recent power outage or is near the end of its service life.	Charge the battery. Batteries require recharging after extended outages and wear out faster when put into service often or when operated at elevated temperatures. If the battery is near the end of its service life, consider replacing the battery even if the replace battery indicator has not illuminated.
The UPS is experiencing an overload condition.	Check the UPS load display. Unplug unnecessary equipment, such as printers.
Display interface LEDs flash sequentially.	
The UPS has been shut down remotely through software or an optional accessory card.	None. The UPS will restart automatically when AC power is restored.
The Error LED is illuminated. The UPS displays an error message and emits a constant beeping sound.	
Internal UPS error detected.	Do not attempt to use the UPS. Contact the Customer Care Center immediately.
The Replace Battery icon is illuminated and the UPS beeps for one minute every five hours.	
The battery has a weak charge.	Allow the battery to recharge for at least four hours. Then, perform a self-test. If the problem persists after recharging, replace the battery.
The Replace Battery icon is flashing and the UPS beeps for once every 2 seconds.	
The replacement battery is not properly connected.	Be sure that the battery connector is securely connected.

Problem and Possible Cause	Solution
The UPS displays a site wiring error message (Error code G.00).	
Wiring errors detected include missing Ground, Hot-Neutral polarity reversal, and overloaded Neutral.	System Error LED will flash on 2 seconds and flash off 1 second to indicate site wiring fault. If the UPS indicates a site wiring error, have a qualified electrician inspect the building wiring. (Applicable for 120 V units only.)
Battery lifestatus (Error code L.01/L.02)	If the LCD indicates battery LifeTime NearEnd or Exceeded, press the MUTE button for 0.2 second to acknowledge the alarm.

System Errors and Message Codes

120 Vac

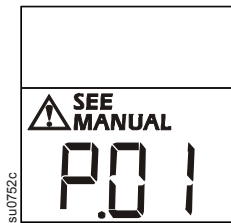

230 Vac

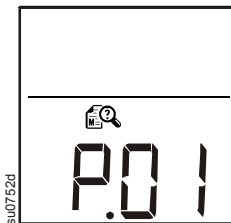

P.00	Output Overload	b.00	Battery Disconnected
P.01	Output Short Circuit	b.01	Battery Over Voltage
P.02	Output Over Voltage	b.02	Battery Need Replacement
P.03	TransformerDCImbalance	b.03	Battery OvertemperatureCritical
P.04	Unit Over Temperature	b.04	Battery Charger
P.05	BackFeedRelay Error	b.05	Battery Temperature Sensor
P.06	AVR Relay Error	b.07	Battery Overtemperature Indicator
P.08	Output Relay Error	b.12	Battery VoltageSensorError
P.13	Inverter Error		
P.17	Green Relay Error		
G.00	SiteWiring	G.07	EPOActive (reserved for 2200 VA and 3000 VA models only)
G.01	EEPROM	G.08	FirmwareMismatch
G.02	ADConverter	G.09	Oscillator
G.03	LogicPowerSupply	G.10	MeasurementMismatch
G.04	InternalCommunication	G.11	Subsystem
G.05	UIButton		
G.06	NeedsFactorySetup		
L.01	LifeTimeNearEnd	L.02	LifeTimeExceeded

The See Manual display icon will not appear when the UPS encounters the following SmartConnect communication states:

Sc.0	SmartConnect No Ethernet	Sc.5	SmartConnect Securing (Transport Layer Security “TLS” being established)
Sc.1	SmartConnect Service Connected	Sc.6	SmartConnect Connecting (application link being established with cloud)
Sc.2	SmartConnect Addressing (obtaining local address DHCP)	Sc.7	SmartConnect Disabled (for Embedded systems when a wombat card is inserted or a configuration has disabled the LCE)
Sc.3	SmartConnect Resolving (addressing completed resolving DNS)	Sc.8	SmartConnect Prohibited unit is in factory mode or hardware prevents operation (EEPROM, MAC or PHY failure)
Sc.4	SmartConnect Contracting (no DNS detection)		

For more information on System Errors, contact customer support at the APC by Schneider Electric Web site, www.apc.com/support.

SmartConnect

APC SmartConnect allows you to monitor the health and status of your UPS from any device connected to the Internet. Visit www.smartconnect.apc.com to learn more.

Battery Replacement

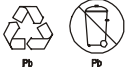

Always recycle used batteries.
For information on recycling a used battery, refer to the Battery Disposal Information sheet included with the replacement battery.

Battery life is highly dependent on temperature and use. To identify when to replace batteries, the Smart-UPS models have a predictive battery replacement date indication and automatic (and configurable) self-tests.

Proactively replace batteries to maintain the highest availability. To ensure safety and high performance, use only genuine APC replacement battery cartridges (RBC™). The APC RBC contains instructions for battery replacement and disposal. To order a replacement battery go to the APC by Schneider Electric Web site, www.apc.com.

UPS Model	Replacement Battery	Battery Module
SMC1000C, SMC1000IC	APCRBC142	Lead acid, 1 module
SMC1500C, SMC1500IC	RBC6	
SMC1000-2UC, SMC1000I-2UC	APCRBC124	
SMC1500-2UC, SMC1500I-2UC	APCRBC157	

Transport

1. Shut down and disconnect all connected equipment.
2. Disconnect the unit from utility power.
3. Disconnect all internal and external batteries (if applicable).
4. Follow the shipping instructions outlined in the *Service* section of this manual.

Service

If the unit requires service, do not return it to the dealer. Follow these steps:

1. Review the *Troubleshooting* section of the manual to eliminate common problems.
2. If the problem persists, contact APC by Schneider Electric Customer Support through the APC Web site, www.apc.com.
 - a. Note the model number and serial number and the date of purchase. The model and serial numbers are located on the rear panel of the unit.
 - b. Call APC Customer Support and a technician will attempt to solve the problem over the phone. If this is not possible, the technician will issue a Returned Material Authorization Number (RMA#).
 - c. If the unit is under warranty, the repairs are free.
 - d. Service procedures and returns may vary internationally. Refer to the APC Web site for country specific instructions.
3. Pack the unit properly to avoid damage in transit. Never use foam beads for packaging. Damage sustained in transit is not covered under warranty.
 - a. **Always DISCONNECT THE UPS BATTERIES before shipping in compliance with U.S. Department of Transportation (DOT) and IATA regulations.** The internal batteries may remain in the UPS.
4. Write the RMA# provided by Customer Support on the outside of the package.
5. Return the unit by insured, prepaid carrier to the address provided by Customer Support.

Limited Factory Warranty

Schneider Electric IT Corporation (SEIT), warrants its products to be free from defects in materials and workmanship for a period of two (2) years from the date of purchase. The SEIT obligation under this warranty is limited to repairing or replacing, at its own sole option, any such defective products. Repair or replacement of a defective product or parts thereof does not extend the original warranty period.

This warranty applies only to the original purchaser who must have properly registered the product within 10 days of purchase. Products may be registered online at warranty.apc.com.

SEIT shall not be liable under the warranty if its testing and examination disclose that the alleged defect in the product does not exist or was caused by end user's or any third person's misuse, negligence, improper installation, testing, operation or use of the product contrary to SEIT's recommendations or specifications. Further, SEIT shall not be liable for defects resulting from: 1) unauthorized attempts to repair or modify the product, 2) incorrect or inadequate electrical voltage or connection, 3) inappropriate on site operation conditions, 4) Acts of God, 5) exposure to the elements, or 6) theft. In no event shall SEIT have any liability under this warranty for any product where the serial number has been altered, defaced, or removed.

EXCEPT AS SET FORTH ABOVE, THERE ARE NO WARRANTIES, EXPRESS OR IMPLIED, BY OPERATION OF LAW OR OTHERWISE, APPLICABLE TO PRODUCTS SOLD, SERVICED OR FURNISHED UNDER THIS AGREEMENT OR IN CONNECTION HEREWITH.

SEIT DISCLAIMS ALL IMPLIED WARRANTIES OF MERCHANTABILITY, SATISFACTION AND FITNESS FOR A PARTICULAR PURPOSE.

SEIT EXPRESS WARRANTIES WILL NOT BE ENLARGED, DIMINISHED, OR AFFECTED BY AND NO OBLIGATION OR LIABILITY WILL ARISE OUT OF, SEIT'S RENDERING OF TECHNICAL OR OTHER ADVICE OR SERVICE IN CONNECTION WITH THE PRODUCTS.

THE FOREGOING WARRANTIES AND REMEDIES ARE EXCLUSIVE AND IN LIEU OF ALL OTHER WARRANTIES AND REMEDIES. THE WARRANTIES SET FORTH ABOVE CONSTITUTE SEIT'S SOLE LIABILITY AND PURCHASER'S EXCLUSIVE REMEDY FOR ANY BREACH OF SUCH WARRANTIES. SEIT WARRANTIES EXTEND ONLY TO ORIGINAL PURCHASER AND ARE NOT EXTENDED TO ANY THIRD PARTIES.

IN NO EVENT SHALL SEIT, ITS OFFICERS, DIRECTORS, AFFILIATES OR EMPLOYEES BE LIABLE FOR ANY FORM OF INDIRECT, SPECIAL, CONSEQUENTIAL OR PUNITIVE DAMAGES, ARISING OUT OF THE USE, SERVICE OR INSTALLATION OF THE PRODUCTS, WHETHER SUCH DAMAGES ARISE IN CONTRACT OR TORT, IRRESPECTIVE OF FAULT, NEGLIGENCE OR STRICT LIABILITY OR WHETHER SEIT HAS BEEN ADVISED IN ADVANCE OF THE POSSIBILITY OF SUCH DAMAGES. SPECIFICALLY, SEIT IS NOT LIABLE FOR ANY COSTS, SUCH AS LOST PROFITS OR REVENUE, WHETHER DIRECT OR INDIRECT, LOSS OF EQUIPMENT, LOSS OF USE OF EQUIPMENT, LOSS OF SOFTWARE, LOSS OF DATA, COSTS OF SUBSTITUANTS, CLAIMS BY THIRD PARTIES, OR OTHERWISE.

NOTHING IN THIS LIMITED WARRANTY SHALL SEEK TO EXCLUDE OR LIMIT SEIT'S LIABILITY FOR DEATH OR PERSONAL INJURY RESULTING FROM ITS NEGLIGENCE OR ITS FRAUDULENT MISREPRESENTATION OF TO THE EXTENT THAT IT CANNOT BE EXCLUDED OR LIMITED BY APPLICABLE LAW.

To obtain service under warranty you must obtain a Returned Material Authorization (RMA) number from customer support. Customers with warranty claims issues may access the SEIT worldwide customer support network through the SEIT Web site: www.apc.com. Select your country from the country selection drop down menu. Open the Support tab at the top of the web page to obtain information for customer support in your region. Products must be returned with transportation charges prepaid and must be accompanied by a brief description of the problem encountered and proof of date and place of purchase.

APC by Schneider Electric Worldwide Customer Support

Customer support for this or any other APC by Schneider Electric product is available at no charge in any of the following ways:

- Visit the APC by Schneider Electric web site to access documents in the APC by Schneider Electric Knowledge Base and to submit customer support requests.
 - **www.apc.com** (Corporate Headquarters)
Connect to localized APC by Schneider Electric web sites for specific countries, each of which provides customer support information.
 - **www.apc.com/support/**
Global support searching APC by Schneider Electric Knowledge Base and using e-support.
- Contact the APC by Schneider Electric Customer Support Center by telephone or e-mail.
 - Local, country specific centers: go to **www.apc.com/support/contact** for contact information.
 - For information on how to obtain local customer support, contact the APC by Schneider Electric representative or other distributor from whom you purchased your APC by Schneider Electric product.



Some models are ENERGY STAR® qualified.

For more information on your specific model go to <http://www.apc.com/company/us/en/sustainability/energy-efficiency/>.

© 2017 APC by Schneider Electric. APC, the APC logo and APC, the APC logo, Smart-UPS and SmartConnect are owned by Schneider Electric Industries S.A.S. or their affiliated companies. All other trademarks are property of their respective owners.