

⊕ : Depending on model / حسب الطراز / В зависимости от модели / Závísí na modelu / Selon le modèle / Abhängig vom Modell / Ανάλογα με το μοντέλο / Típusfüggő / In base al modello / Zależnie od modelu / Dependendo do modelo / În funcție de model / В зависимости от модели / U zavisnosti od modela / Ovisno o modelu / Odvisno od modela / En función del modelo / Modele bağlı olarak değişkenlik gösterebilir / Залежно від моделі / Rusumga qarab





English

- Read **Safety and Reference**.
- For the power supply and power consumption, refer to the label attached to the product.

Български

- Прочетете **Безопасност и справки**.
- Направете справка с етикета на продукта за електрозахранването и консумацията на енергия.

Français

- Lire le document **Sécurité et référence**.
- Reportez-vous à l'étiquette apposée sur le téléviseur pour connaître l'alimentation et la consommation électriques.

Ελληνικά

- Ανάγνωση **Ασφάλεια και αναφορά**.
- Για πληροφορίες σχετικά με την τροφοδοσία και την κατανάλωση ενέργειας, δείτε την ετικέτα του προϊόντος.

Italiano

- Consultare la sezione **Sicurezza e informazioni di riferimento**.
- Per l'alimentazione e il consumo di energia, consultare l'etichetta applicata sul prodotto.

Português

- Consulte o manual de **Segurança e Referência**.
- No que respeita à fonte de alimentação e ao consumo de energia, consulte a etiqueta mostrada no produto.

Русский

- Прочтите **Руководство по технике безопасности**.
- Требования параметров электропитания и значения потребляемой мощности указаны на информационном лейбле на задней крышке изделия.

Hrvatski

- Pročitajte **Sigurnost i reference**.
- Informacije o napajanju i potrošnji energije potražite na oznaci koja se nalazi na proizvodu.

Español

- Leer **Seguridad y Referencias**.
- Para obtener información acerca de la fuente de alimentación y el consumo de energía, consulte la etiqueta del producto.

Українська

- Прочитайте **Правила безпеки та довідкова інформація**.
- Відомості щодо подачі живлення і споживання електроенергії дивіться на наліпці на виробі.

العربية

- قراءة السلامة والمرجع.
- لمعرفة المزيد حول مصدر الإمداد بالطاقة ومعايير استهلاك الطاقة، راجع الملصق الموجود على المنتج.

Česky

- Přečtěte si část **Bezpečnost a reference**.
- Informace o napájení a příkonu naleznete na štítku připevněném k výrobku.

Deutsch

- **Sicherheitshinweise und Referenzen:** Bitte lesen!
- Informationen zur Stromversorgung und zum Stromverbrauch sind dem Etikett auf dem Gerät zu entnehmen.

Magyar

- Lásd: **Biztonsági óvintézkedések**.
- A tápellátásra és az áramfogyasztásra vonatkozó adatok a készülékre ragasztott címkén találhatóak.

Polski

- Przeczytaj **Zasady bezpieczeństwa i informacje dodatkowe**.
- Dokładne informacje o zasilaniu i zużyciu energii są umieszczone na etykietce znajdującej się na produkcie.

Română

- Citiți **Siguranță și referințe**.
- Pentru sursa de alimentare și consumul de energie, consultați eticheta atașată pe produs.

Srpski

- Pročitajte **Bezbednost i informacije**.
- Da biste saznali informacije u vezi sa napajanjem i potrošnjom energije, pogledajte oznaku na proizvodu.

Slovenščina

- Preberite **Varnostne informacije in napotki**.
- Podatke o napajanju in porabi energije si oglejte na nalepki izdelka.

Türkçe

- **Güvenlik ve Referans** bölümünü okuyun.
- Güç kaynağı ve güç tüketimi için ürüne yapıştirilmiş olan etikete bakın.

O'zbekcha

- **Xavfsizlik bo'yicha ko'rsatmalar va havolalar** o'qib chiqing.
- Quvvat ta'minoti va quvvat iste'moli uchun mahsulotga yopishtirilgan yorliqqa qarang.

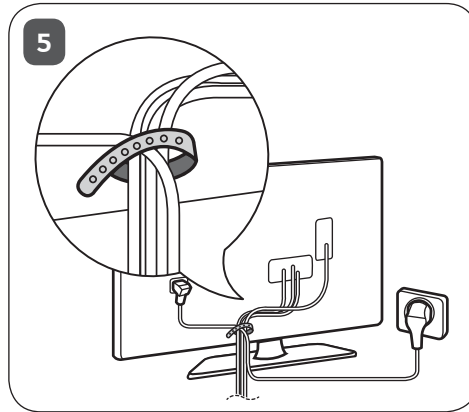
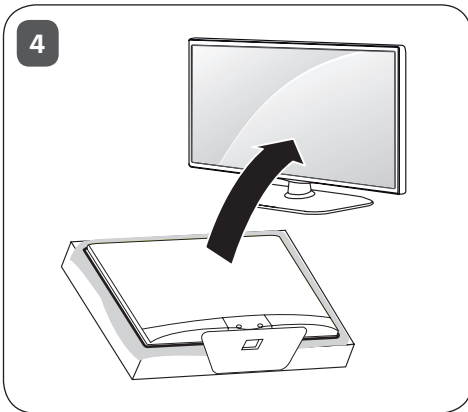
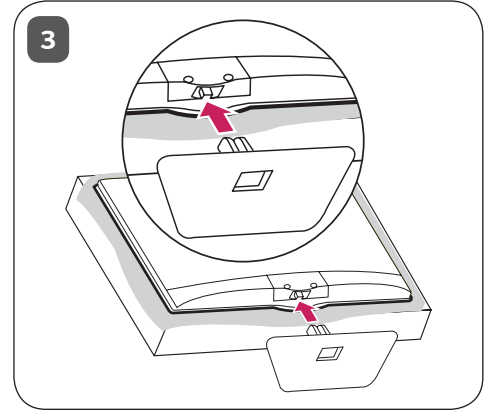
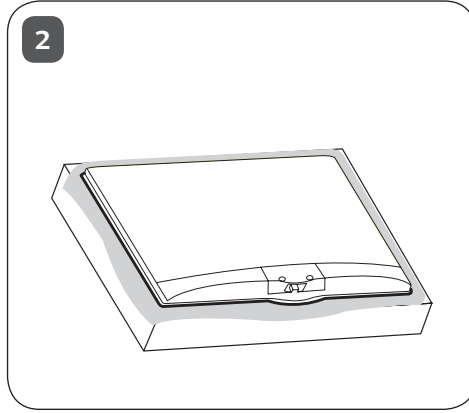
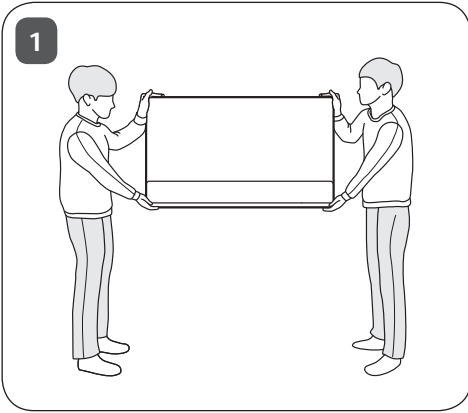

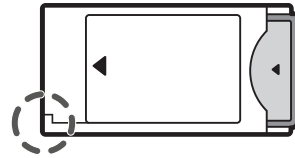
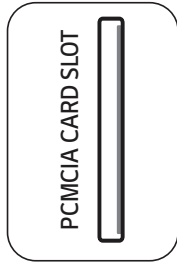
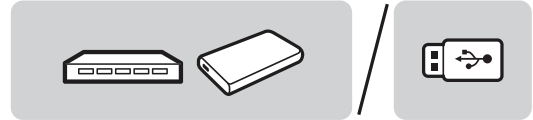
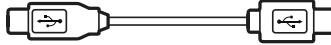
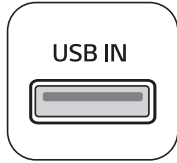
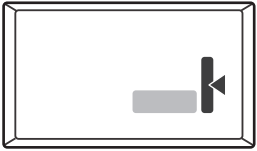

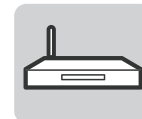
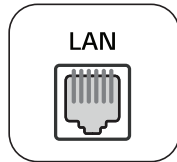
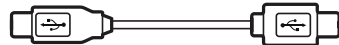
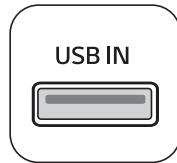
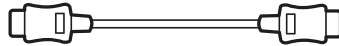
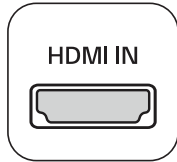
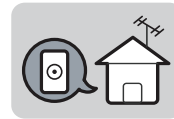
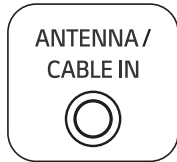
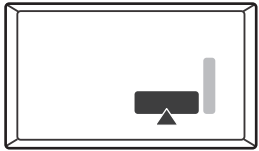

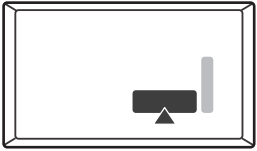

**OPTICAL
DIGITAL
AUDIO OUT**

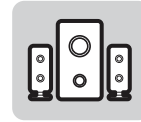
A square icon with a smaller square inside, representing the optical digital audio out connector.

**RS-232C IN
(CONTROL&SERVICE)**

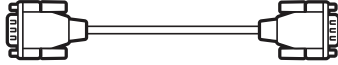
A grey icon of an RS-232C in connector with five pins.

**EXTERNAL
SPEAKER OUT**

A grey icon of an external speaker out connector with a central circular hole.

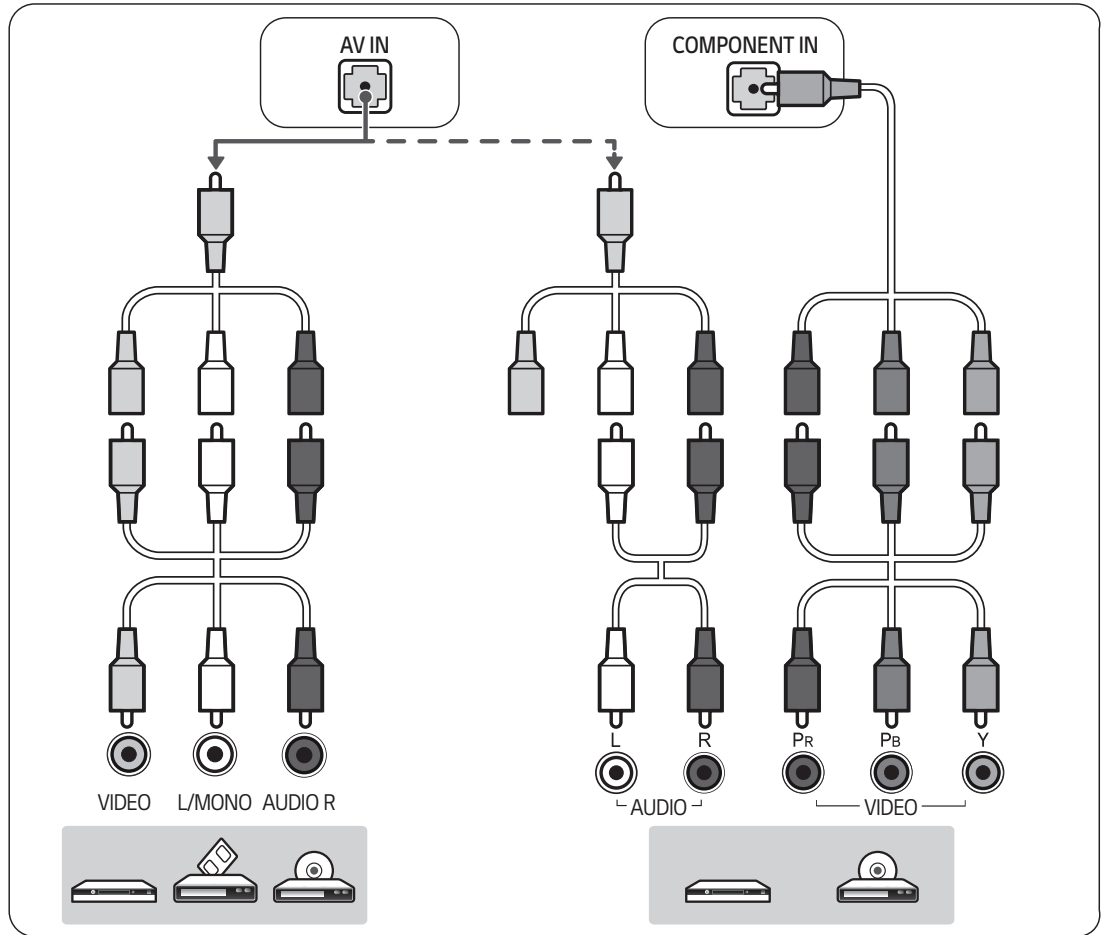
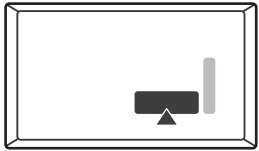

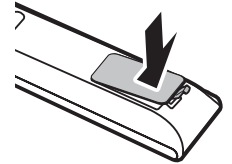
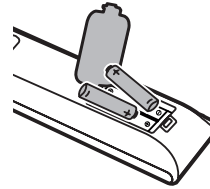
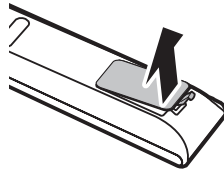
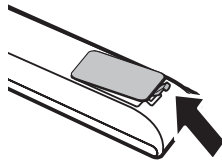
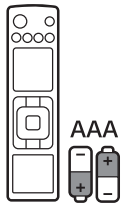

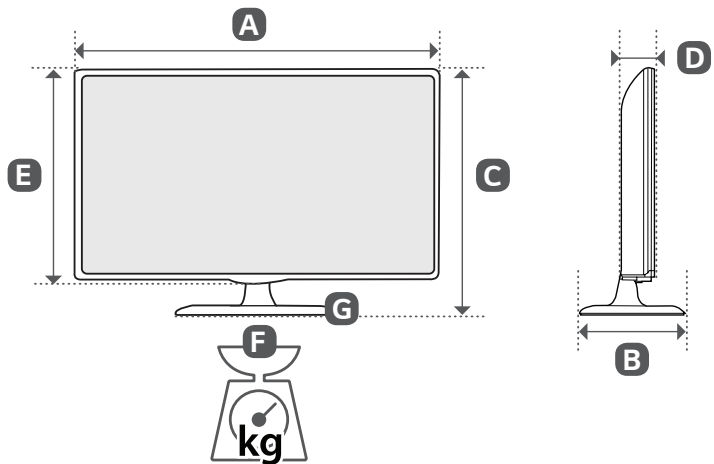

	A	B	C	D	E	F	F - G
	(mm)					(kg)	
24LT661HBZA	556	140.6	384.3	53.1	343.1	3.7	3.5
Power requirement					AC 100-240 V ~ 50 / 60 Hz		