

deco™ | Smart Home Mesh Wi-Fi System  
Whole Home Wi-Fi | Seamless Roaming | Parental Controls | Antivirus



# User Guide

AC2200 Smart Home Mesh Wi-Fi System  
Deco M9 Plus



# Contents

About This Guide .....	1	Blacklist .....	19
Appearance .....	2	Online Upgrade .....	20
Set Up Your Deco .....	3	WPS .....	21
Add More Decos .....	6	Parental Controls .....	22
Dashboard .....	7	Antivirus .....	23
Check Deco Status .....	8	QoS .....	24
Manage Connected Devices .....	9	Monthly Report .....	25
Create New Networks .....	10	Managers .....	26
Remove/Reboot Deco .....	12	Advanced Features .....	27
Shortcut .....	13	Authentication .....	32
Automation .....	14		
Wi-Fi Settings .....	16		
Internet Speed Test .....	17		
Network Optimization .....	18		



# About This Guide

This guide provides a brief introduction to AC2200 Smart Home Mesh Wi-Fi System and the Deco app, as well as regulatory information.

Features available in Deco may vary by model and software version. Deco availability may also vary by region or ISP. All images, steps, and descriptions in this guide are only examples and may not reflect your actual Deco experience.

## Conventions

In this guide, the following conventions are used:

Convention	Description
Deco	Stands for AC2200 Smart Home Mesh Wi-Fi System/Unit.
<u>Underline</u>	Hyperlinks are in teal and underlined. You can click to redirect to a website or a specific section.
Teal	Key information appears in teal, including management page text such as menus, items, buttons and so on.
 Note:	Ignoring this type of note might result in a malfunction or damage to the device.
 Tips:	Indicates important information that helps you make better use of your device.

## More Info

- Specific product information can be found on the product page at <https://www.tp-link.com>.
- A community is provided for you to discuss our products at <https://community.tp-link.com>.
- Our Technical Support contact information can be found at the [Help center](#) of the Deco app and the [Contact Technical Support](#) page at <https://www.tp-link.com/support/>.

## Speed/Coverage/Device Quantity Disclaimer

Maximum wireless transmission rates are the physical rates derived from IEEE Standard 802.11 specifications. Range, coverage, and maximum quantity of connected devices are based on test results under normal usage conditions. Actual wireless data throughput, wireless coverage, and quantity of connected devices are not guaranteed and will vary as a result of 1) environmental factors, including building materials, physical objects, and obstacles, 2) network conditions, including local interference, volume and density of traffic, product location, network complexity, and network overhead, and 3) client limitations, including rated performance, location, connection quality, and client condition.

## HomeCare Disclaimer

A basic TP-Link HomeCare™, powered by Trend Micro™, package is included for 3 years from date of activation at no additional cost. It includes Parental Controls, Quality of Service, and Antivirus. Deactivation of HomeCare™ will disable certain controls and protections. For a complete list of HomeCare™ functions, go to <https://www.tp-link.com>.

## IoT Compatibility Disclaimer

IoT compatibility refers only to smart devices that can be controlled via the Deco app. Other wireless devices can still connect to Deco for normal Wi-Fi use.

## Seamless Roaming Disclaimer

Clients need to support 802.11k/v/r and may require additional set up. Performance may vary depending on the client device.

# Appearance

Each Deco has an LED that changes color according to its status, two RJ-45 Ethernet ports and a power slot. See the explanation below:

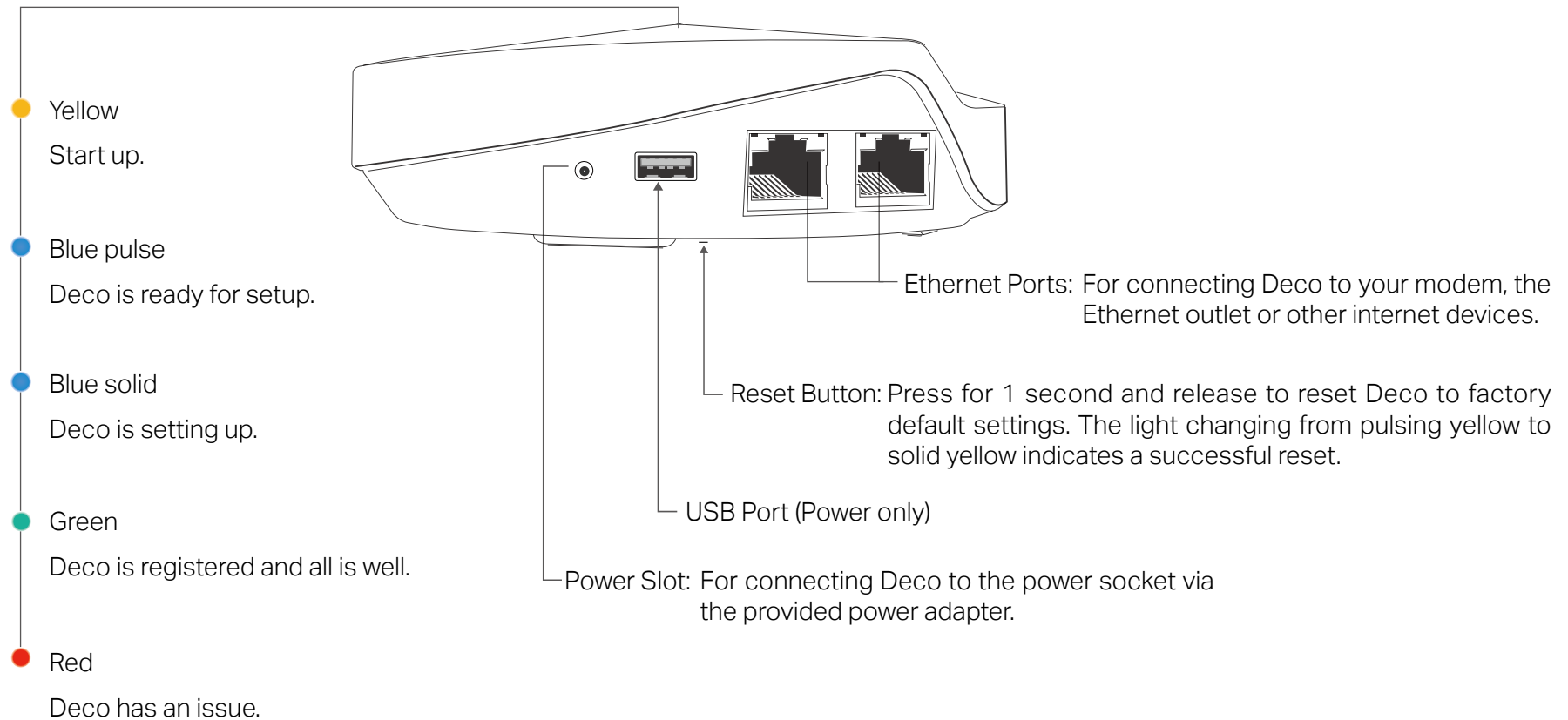

# Set Up Your Deco

The intuitive Deco app guides you through an easy setup process that gets each unit up and running and all your devices connected and online. Follow the steps below to set up your Deco Whole Home Mesh Wi-Fi System.

## 1. Download and install the Deco app

Scan the QR code below or go to Google Play or the Apple App Store to download the Deco app. Install the app on your Android or iOS smartphone or tablet.



or



## 2. Log in or sign up with TP-Link ID

Open the app. Use your TP-Link ID to log in. If you don't have a TP-Link ID, sign up first.

**Note:** If you forgot your login password, tap [Forgot password?](#). The Deco app will guide you through the rest.

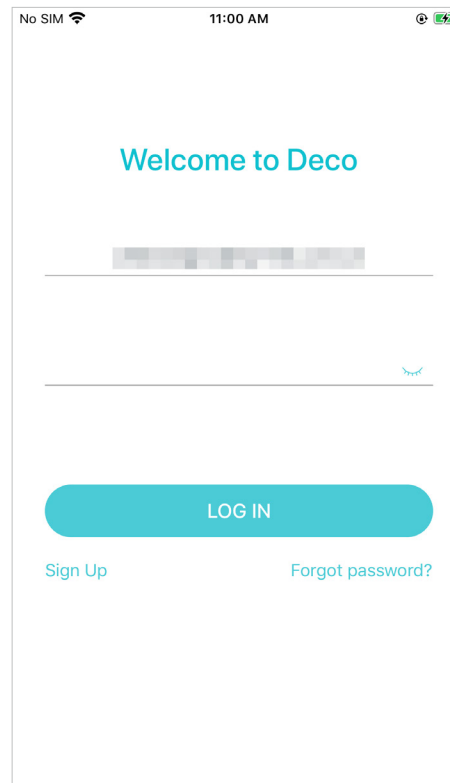

## 3. Identify your Deco

Choose your Deco model.



#### 4. Connect your modem to Deco

Power off your modem. Connect your Deco to the modem and power them both on.

If you don't have a modem, connect the Ethernet outlet directly to your Deco.

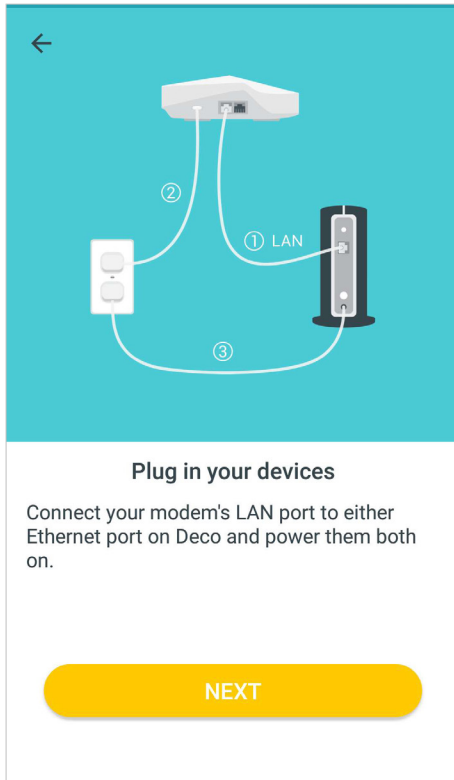

#### 5. Select a location

Select a location for this Deco. If its location is not listed, you can create a new one by choosing [Custom](#).

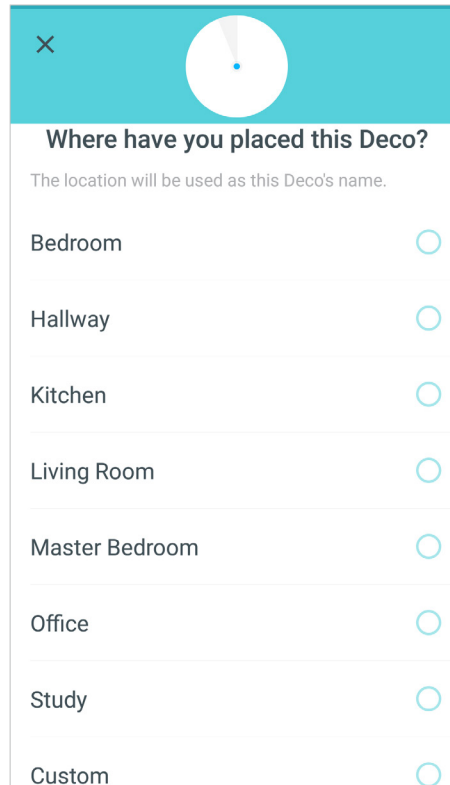

#### 6. Set up internet connection

Select the internet connection type and enter the information. If you are not sure, contact your internet service provider.

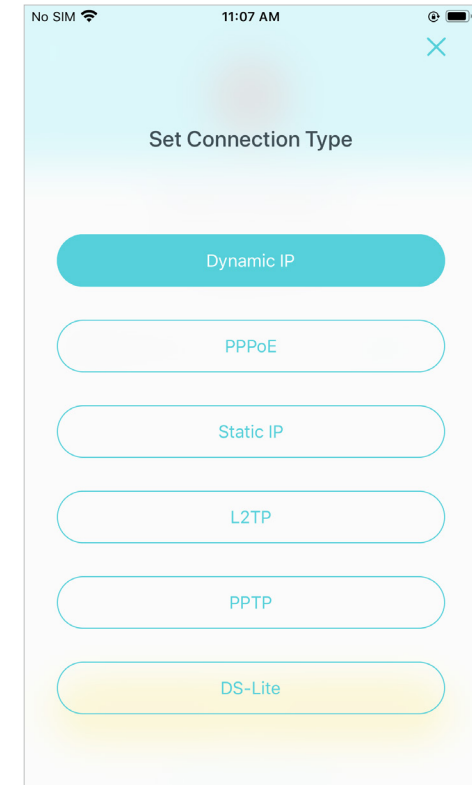

## 7. Create your Wi-Fi network

Set a network name and a password. These will be the name and password you use to connect your devices to Wi-Fi.

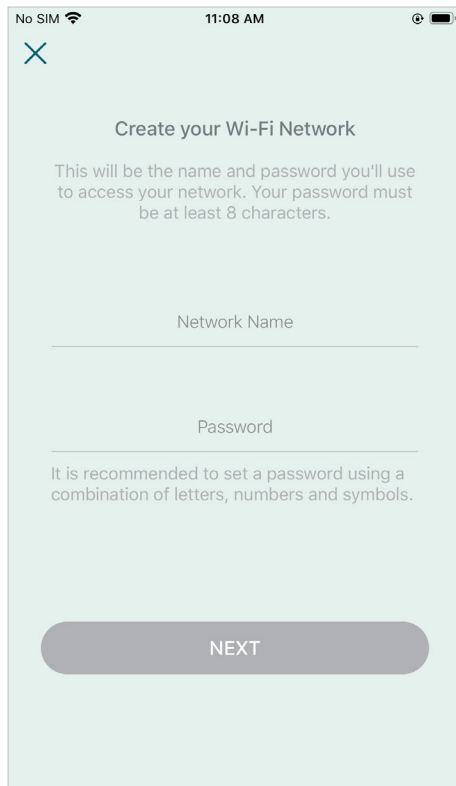

No SIM 11:08 AM

✕

### Create your Wi-Fi Network

This will be the name and password you'll use to access your network. Your password must be at least 8 characters.

Network Name

Password

It is recommended to set a password using a combination of letters, numbers and symbols.

NEXT

## 8. Setup complete

Your Deco network is now up. Add more Decos or complete the setup and connect all devices to the Deco network.

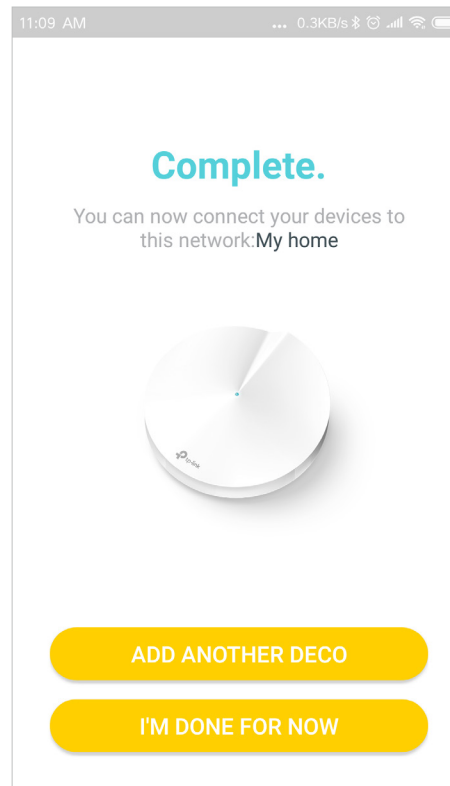

# Add More Decos

After created a Deco network, you can add more Deco units into the network to expand the Wi-Fi coverage, and manage them conveniently on your Deco app.

On the Overview page, Tap 

Select the Deco model you want to add, and follow app instructions to complete the setup

After the setup, you can find the added Decos by tapping 

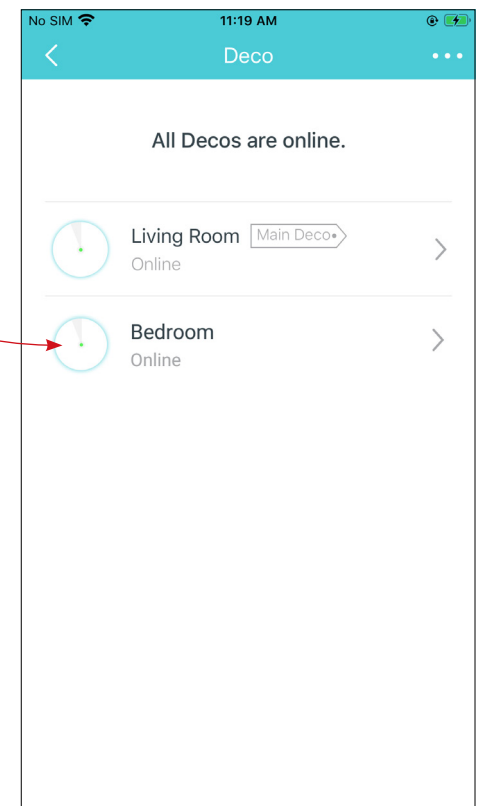
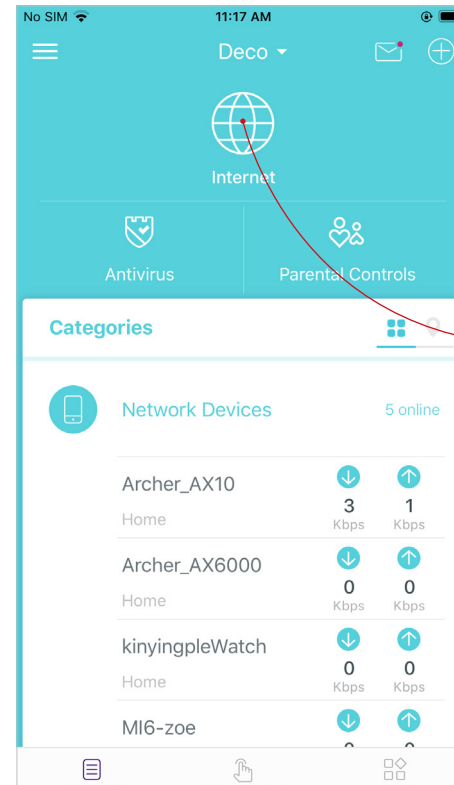
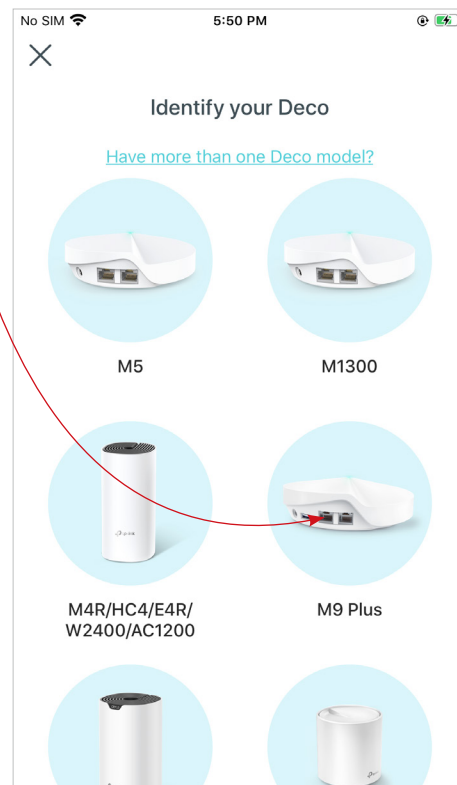
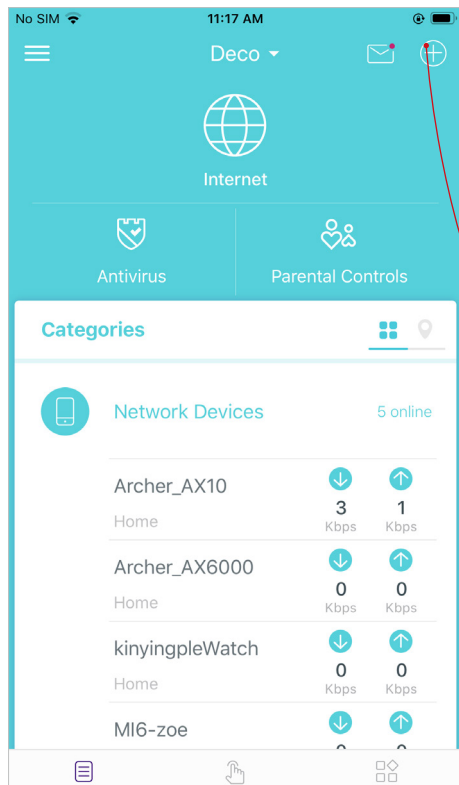



# Dashboard

After you successfully set up your Deco network, you will see the dashboard of the Deco app. Here you can get an overview of the network status, create shortcut and automation, and set up various advanced features.

Tap  to get an overview of the network status

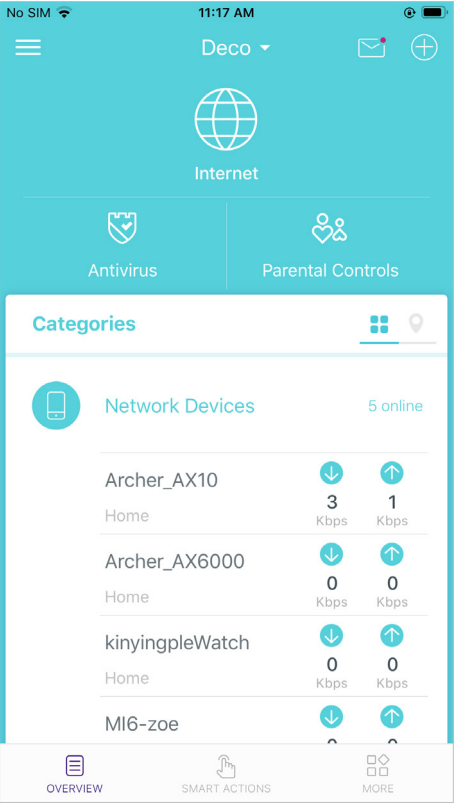

Tap  > [Shortcut](#) to create or execute shortcut

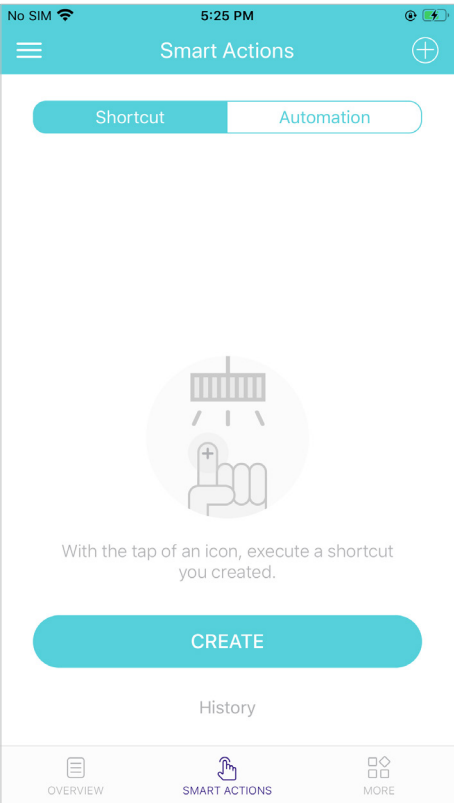

Tap  > [Automation](#) to set interactions between your smart devices

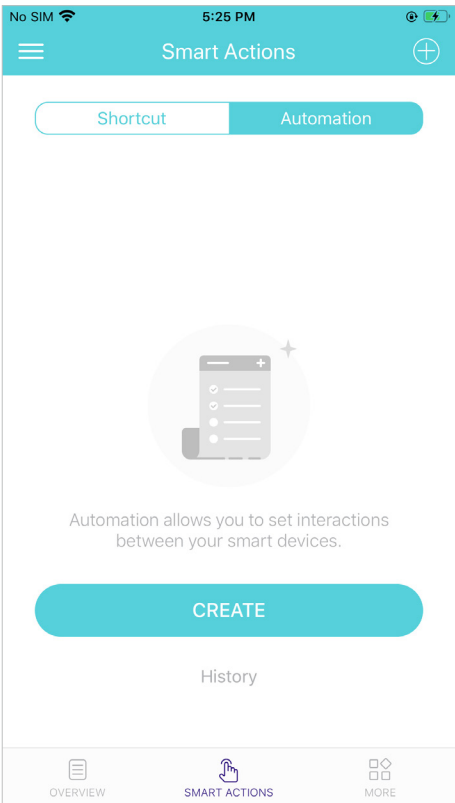

Tap  for more features

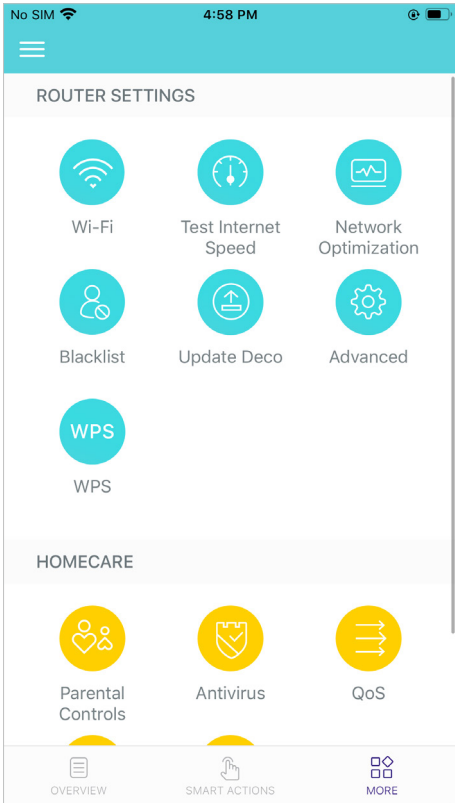

# Check Deco Status

In the Overview page, you can check the working status of all the Decos, check the Deco details, change or customize the location, and more.

Tap  to check all Decos' status

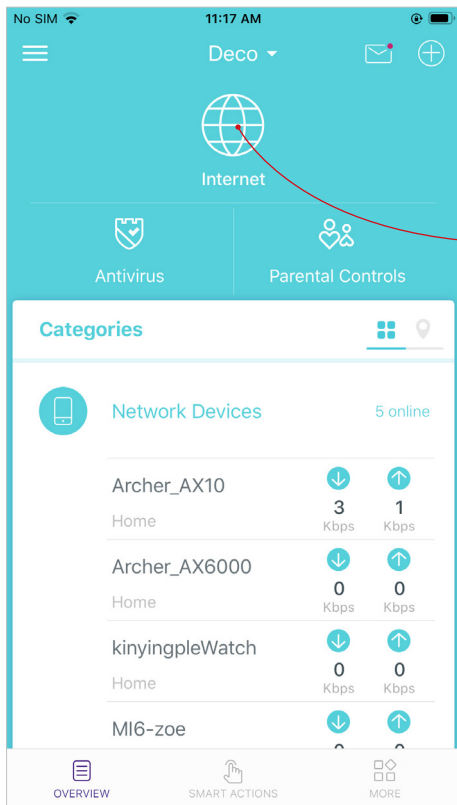

Tap a Deco unit to check the details

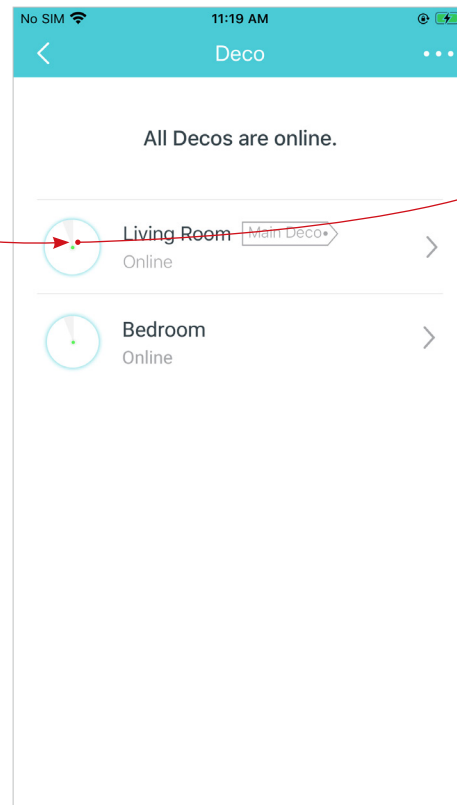

Tap the Deco unit to change or customize the location

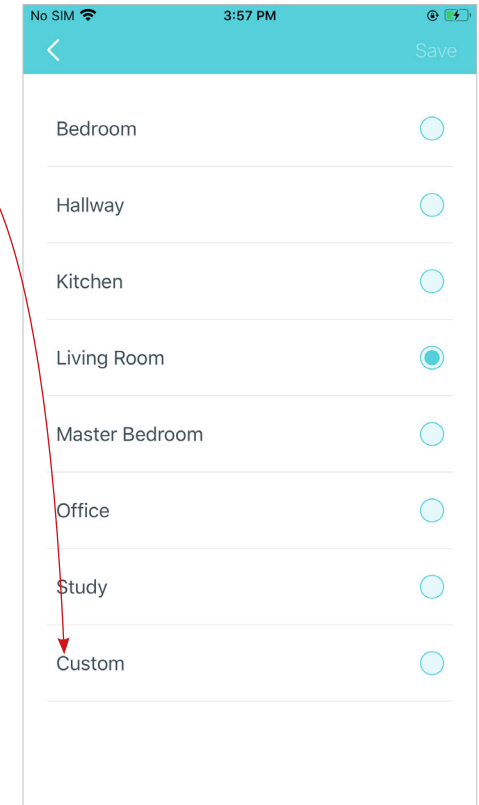
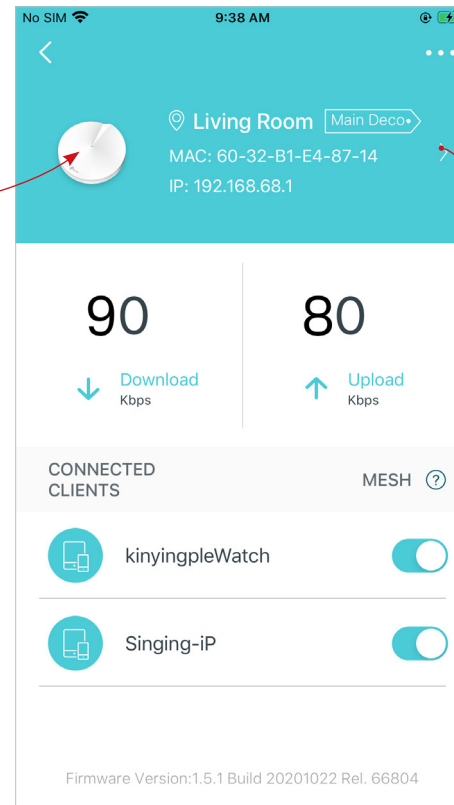

# Manage Connected Devices

In the Overview page, you can check the working status of all the connected devices, view the device details, or change the device settings.

Tap a client on the [Network Devices](#) list to check the details

Tap  to manage the device settings

Tap [Belongs to](#) to add a unique profile for the device and manage its online activities

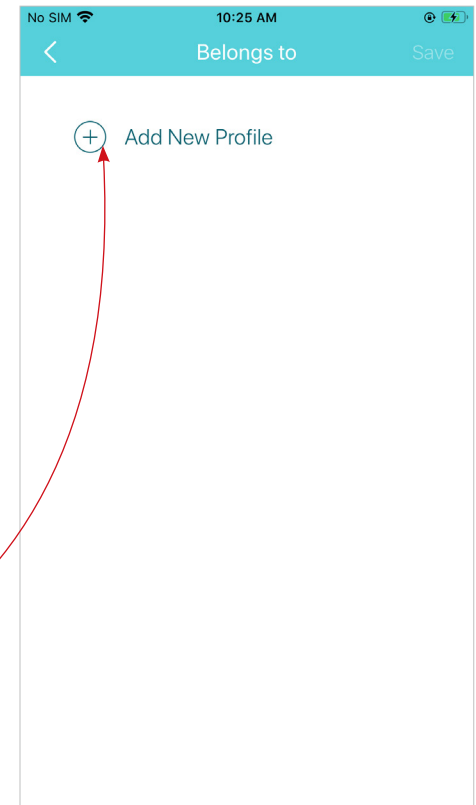
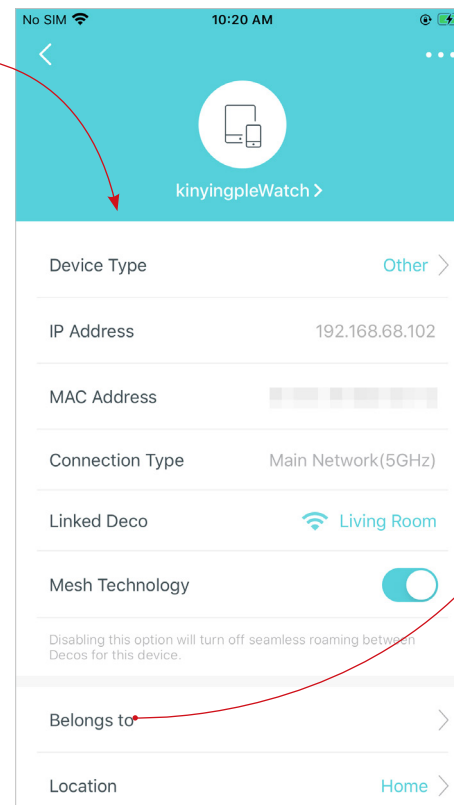
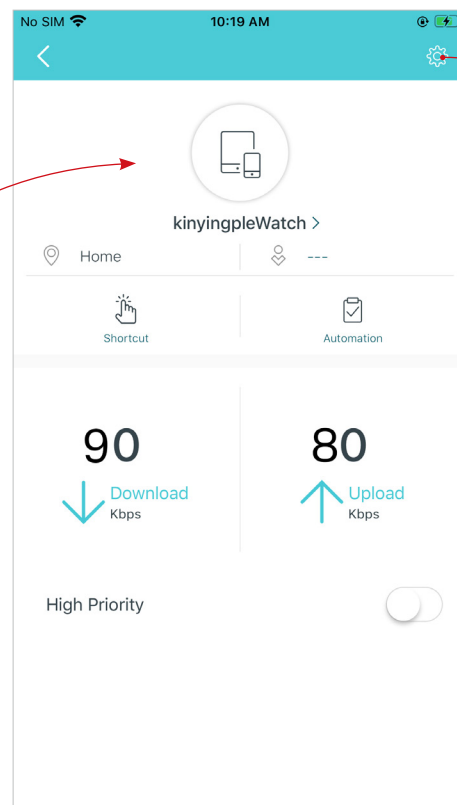
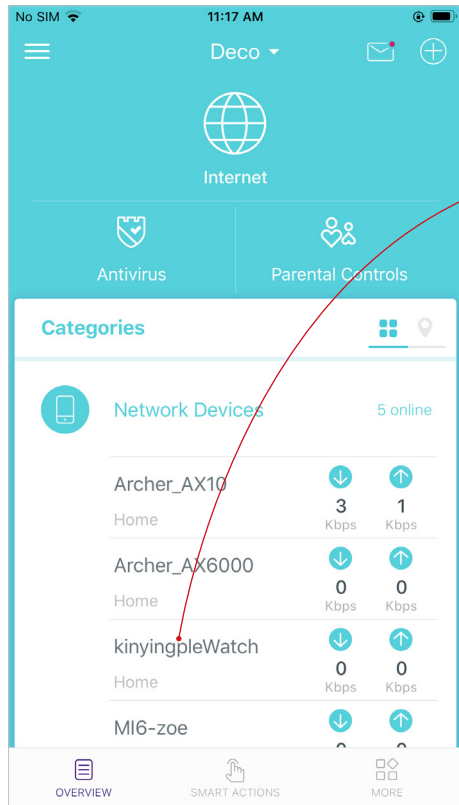

# Create New Networks

On the Deco app, you can create different Deco networks bound to your TP-Link ID, and manage them conveniently from the Deco app with one account. You can also help family or friends by managing their network on your Deco app. Two methods are provided as below to create a new network:

## Method 1. Create a new network from the Overview page

Tap  > [Create New Network](#)

Then follow the app instructions to complete the setup

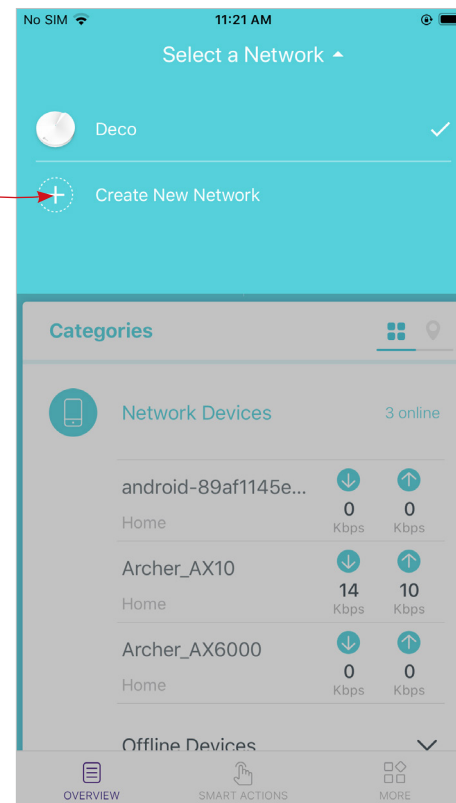
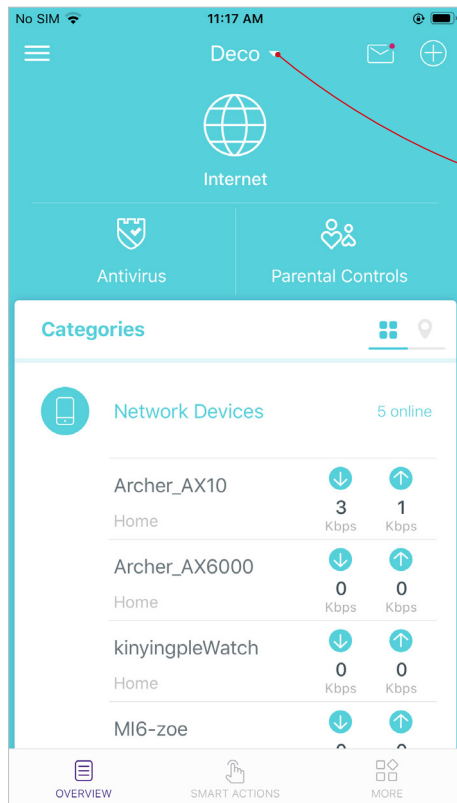

# Create New Networks

On the Deco app, you can create different Deco networks bound to your TP-Link ID, and manage them conveniently from the Deco app with one account. You can also help family or friends by managing their network on your Deco app. Two methods are provided as below to create a new network:

## Method 2. Create a new network from the Menu page

Tap  to open the Menu

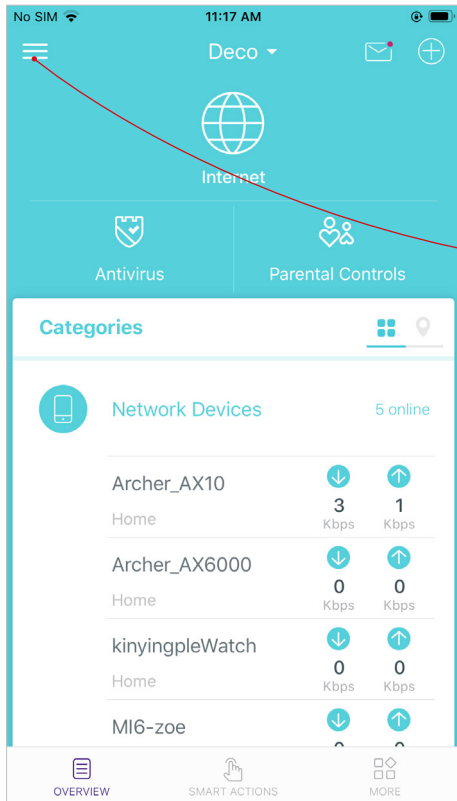

Tap  > [CREATE NEW NETWORK](#)

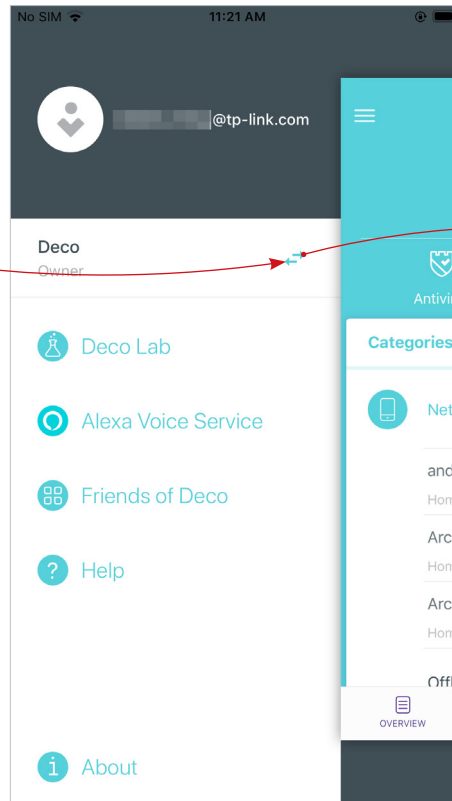

Follow app instructions to complete the setup

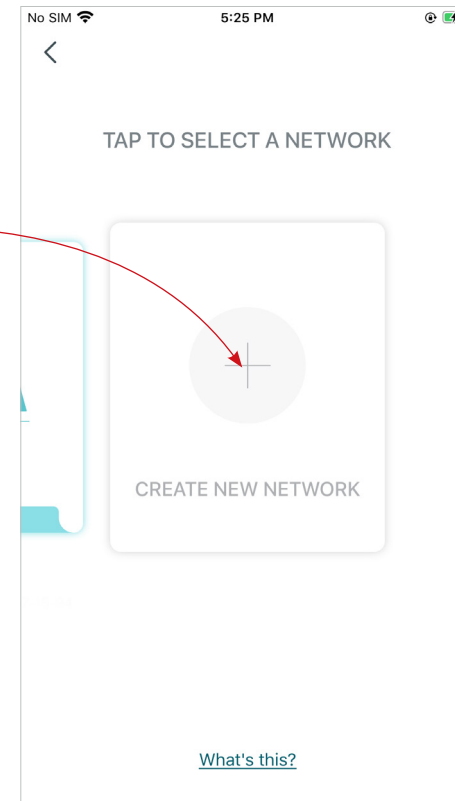

# Remove/Reboot Deco

You can remove or reboot your Deco easily on the Deco app. Follow the steps below.

Tap  to check all Decos' status

Tap a Deco unit to enter the details

Tap  to remove or reboot the Deco

**Note:** If the LED light of Deco does not turn pulsing blue after tapping Remove, refer to [Appearance](#) to use the reset button to reset it.

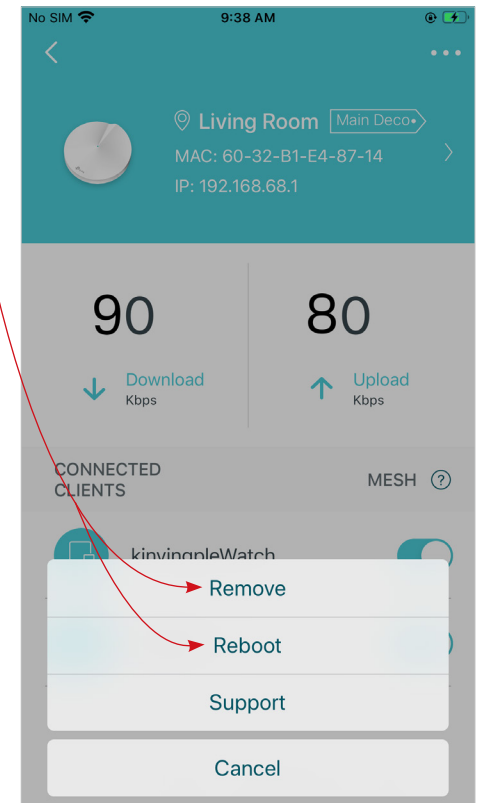
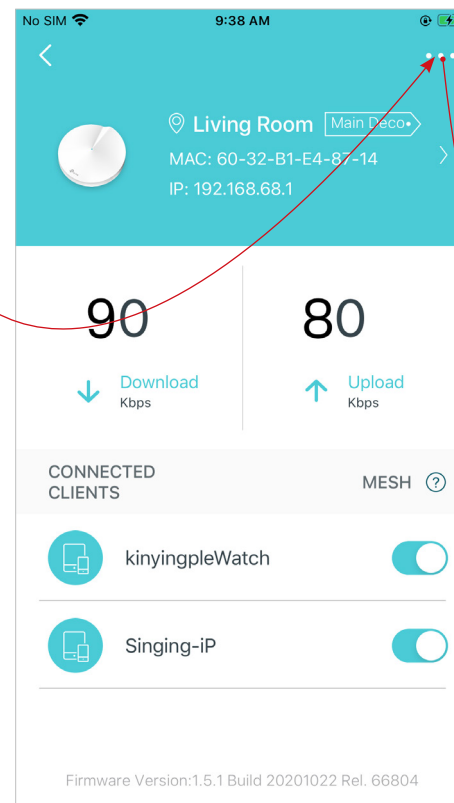
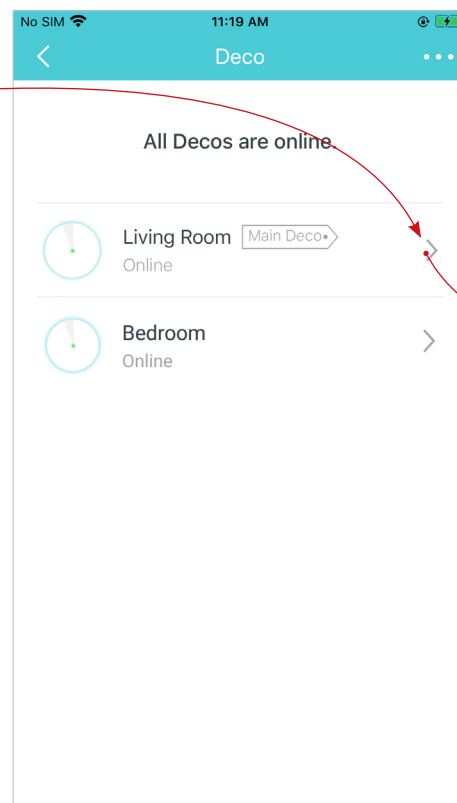
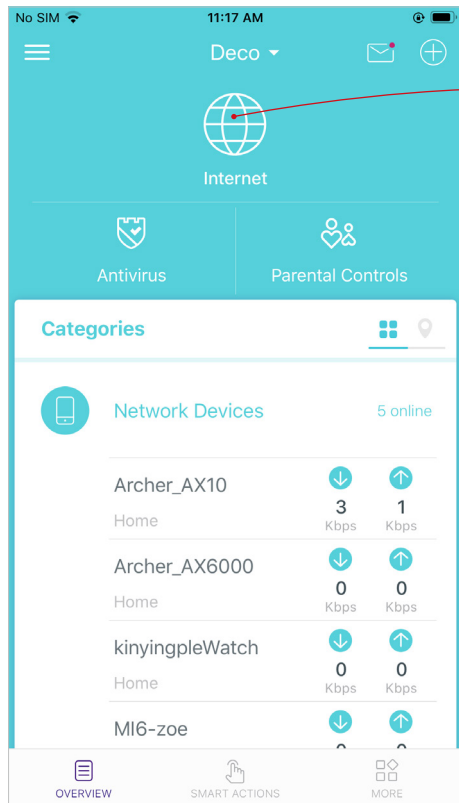

# Shortcut

Shortcut lets you achieve an action with a simple tap.

Tap  > [Shortcut](#) > [CREATE](#)

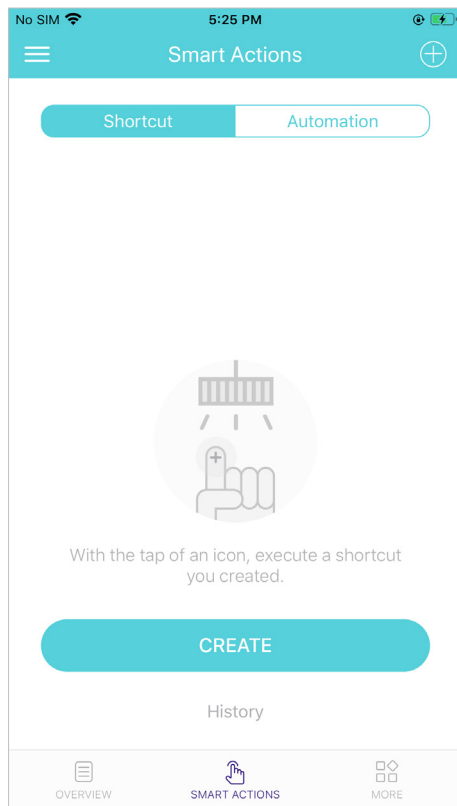

Add actions

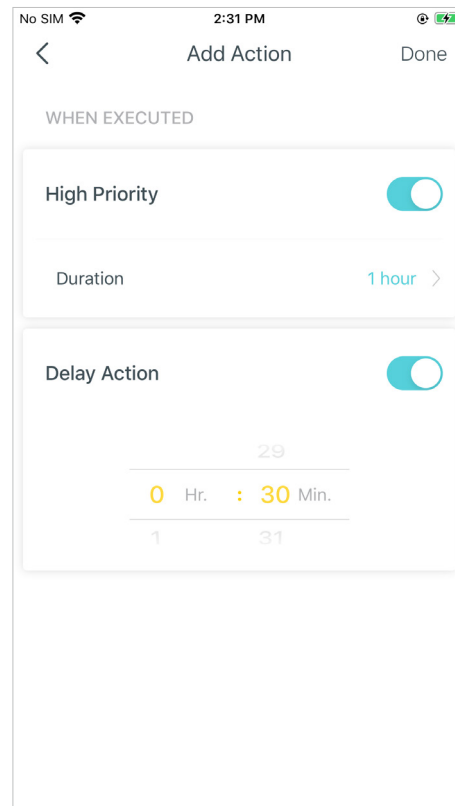

Create shortcuts

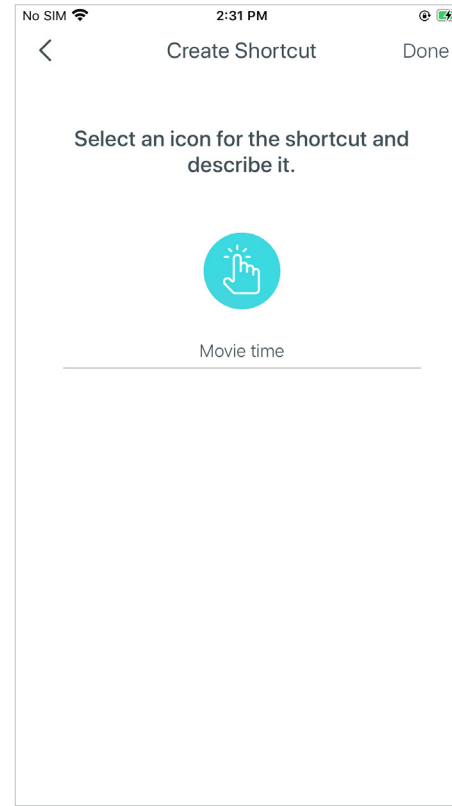

Tap the icon to execute the shortcut  
Tap the name to edit the shortcut

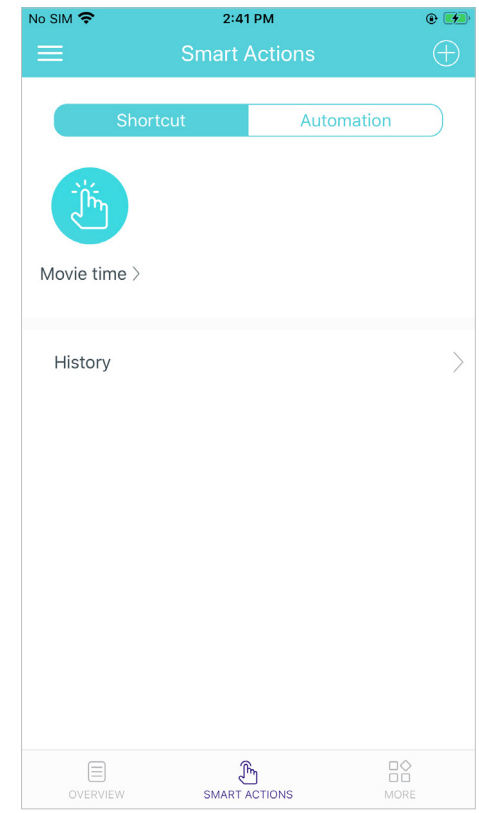

# Automation

Automation allows you to set interactions between your smart devices by adding triggers and actions. For example, if the bedroom light turns on (which is a trigger), and then the air conditioner in the bedroom will start running (which is an action).

Tap  > Automation > CREATE

Set effective time

Add triggers

Add actions

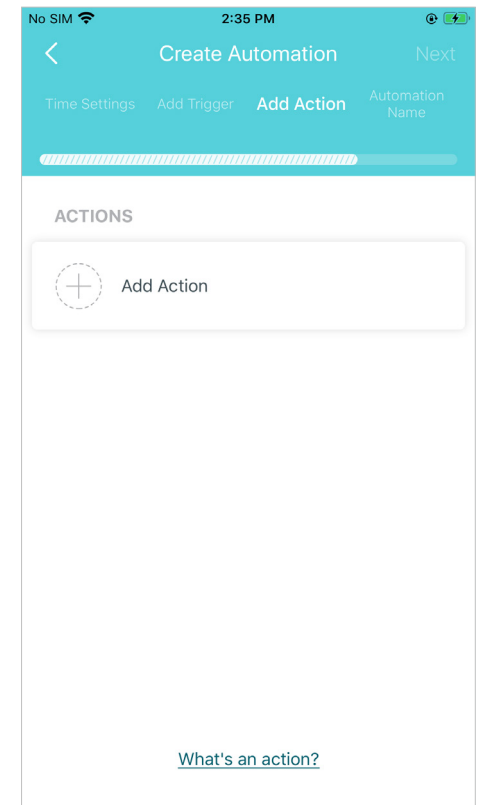
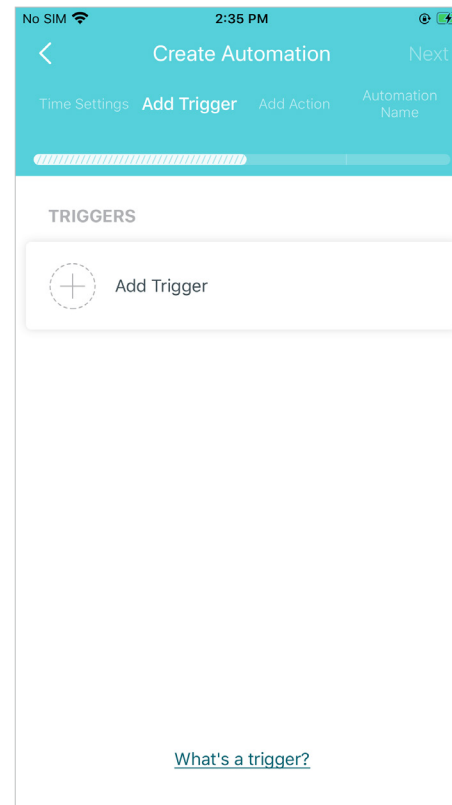
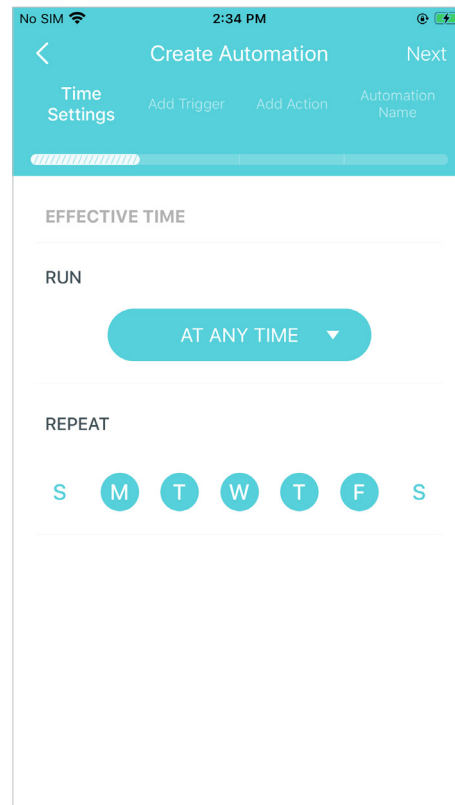
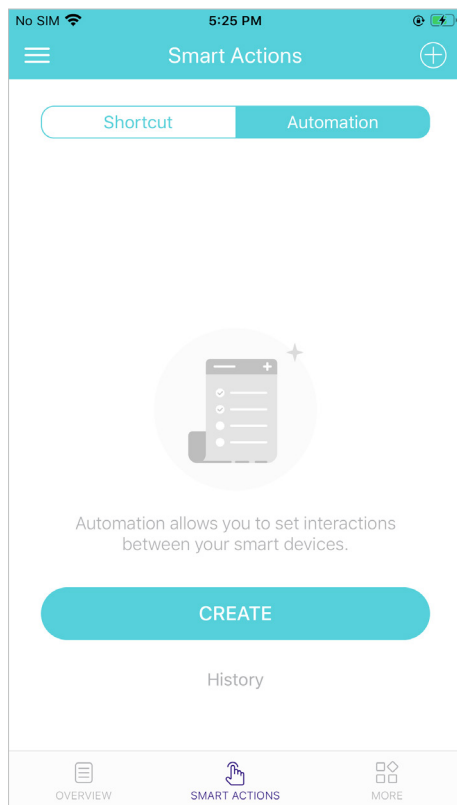



Set a name for the automation

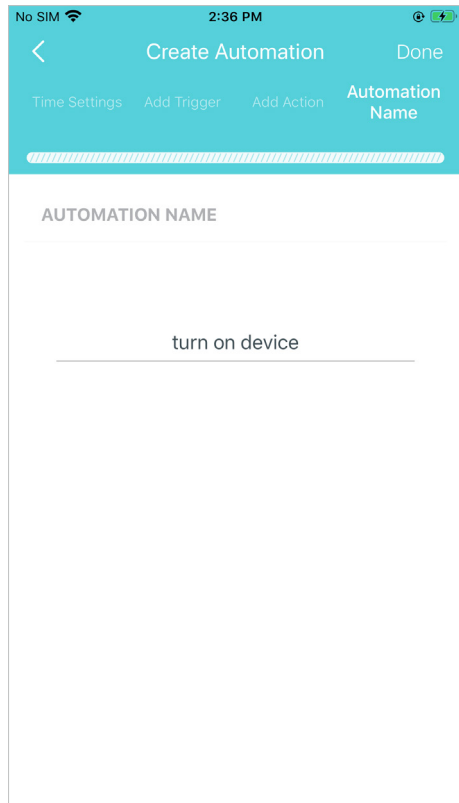

Automation setup complete

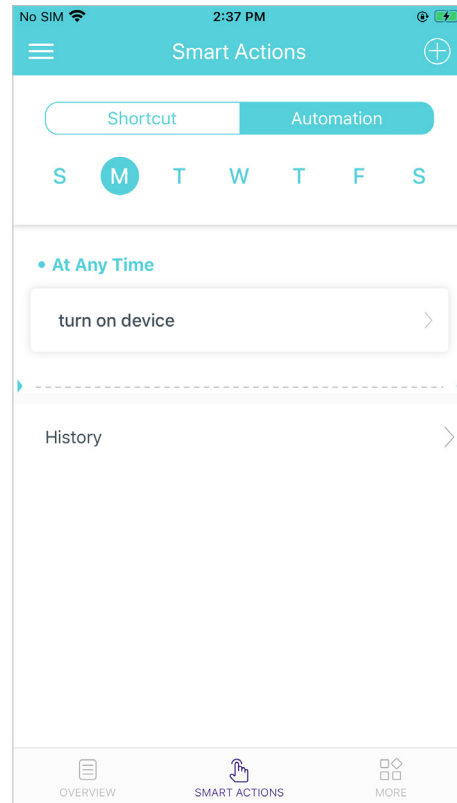

# Wi-Fi Settings

You can change the network name and password of your main network, create a separate network for guests to guarantee the security and privacy of your main network, and shake your device to share the network details easily with family and friends.

Tap  > Wi-Fi

Manage your main network (e.g. change your Wi-Fi network name and password)

Enable guest network

Shake to share your network

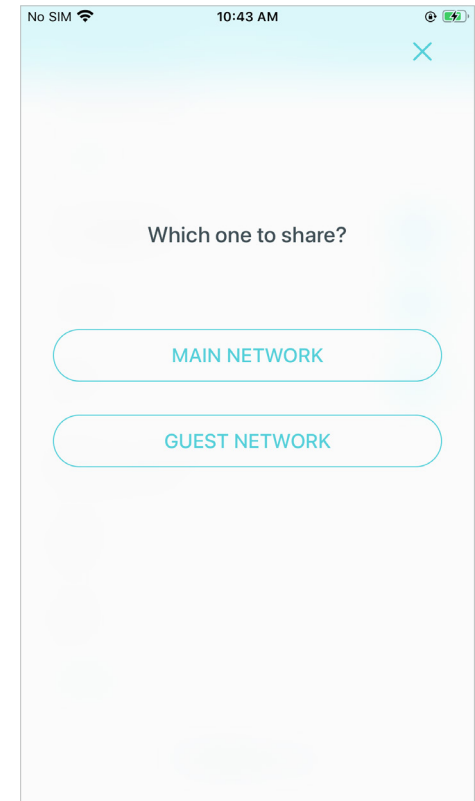
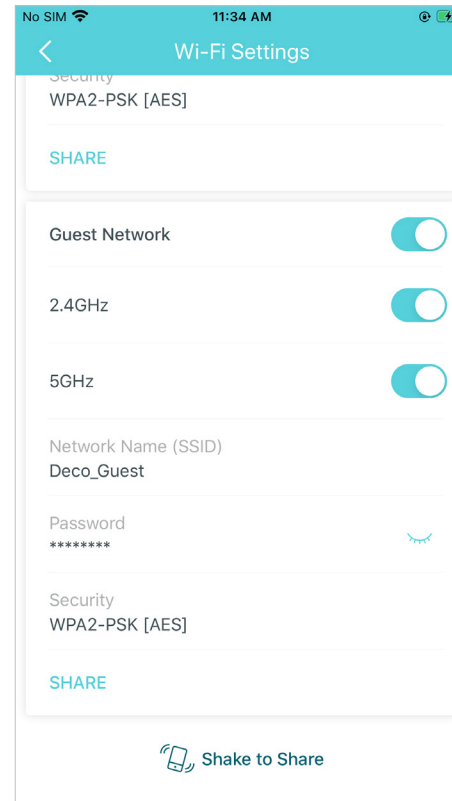
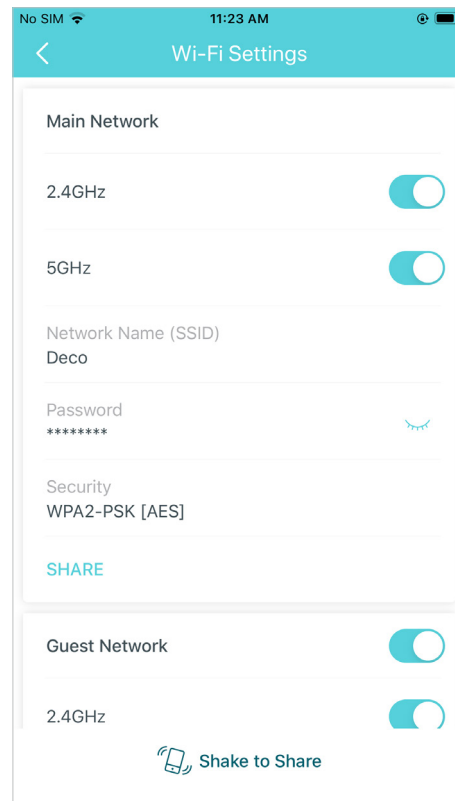
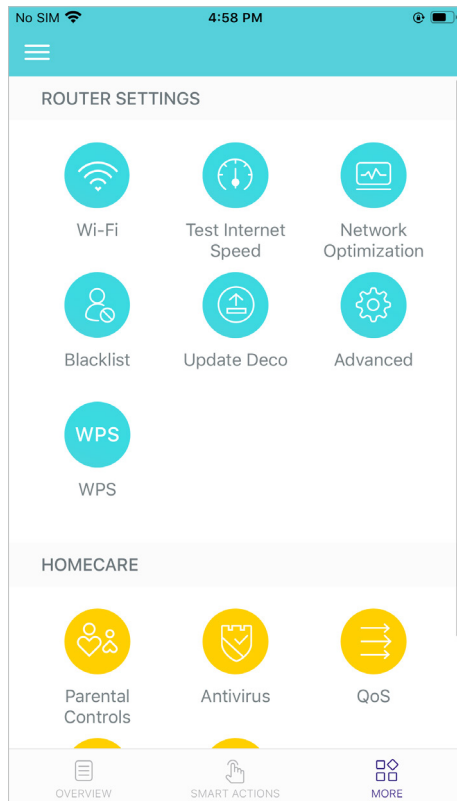

# Internet Speed Test

Test your internet speed to see what you can do on your network. You will get an internet speed rating report after the test.

Tap  > Test Internet Speed

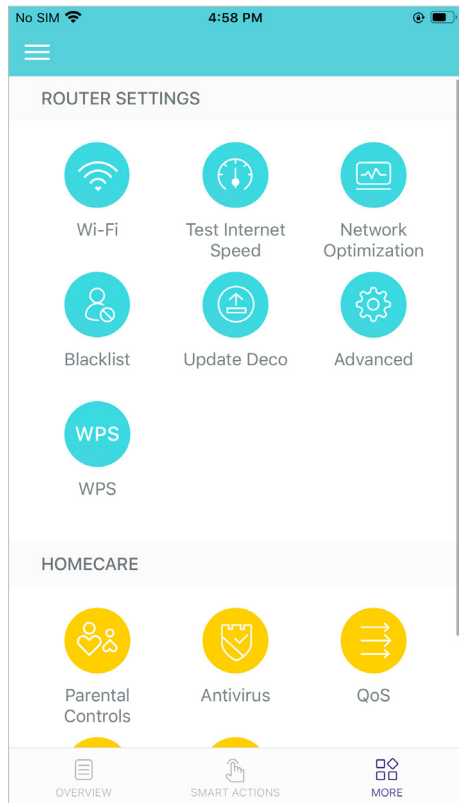

Tap **TEST** to start testing

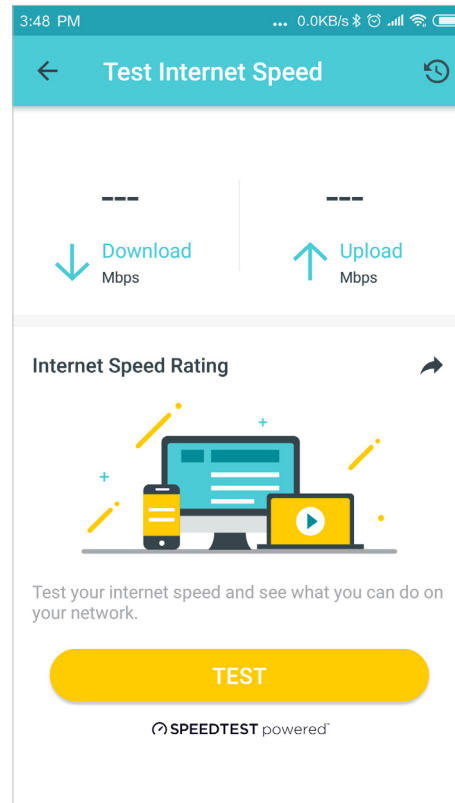

Get speed test report

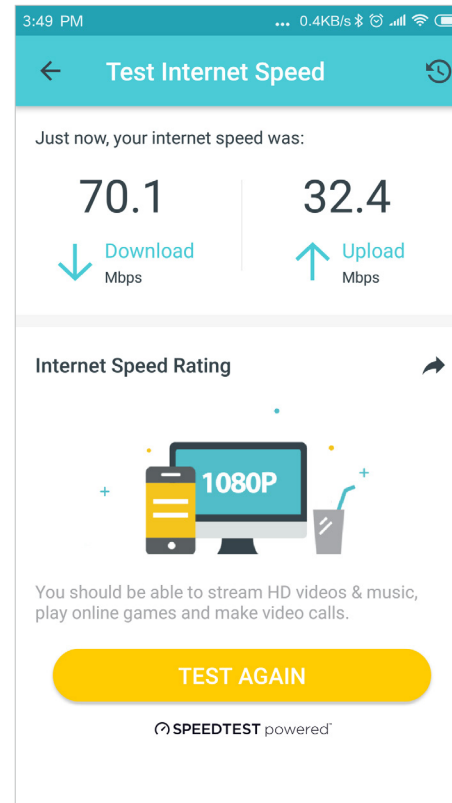

Tap  to check speed test history

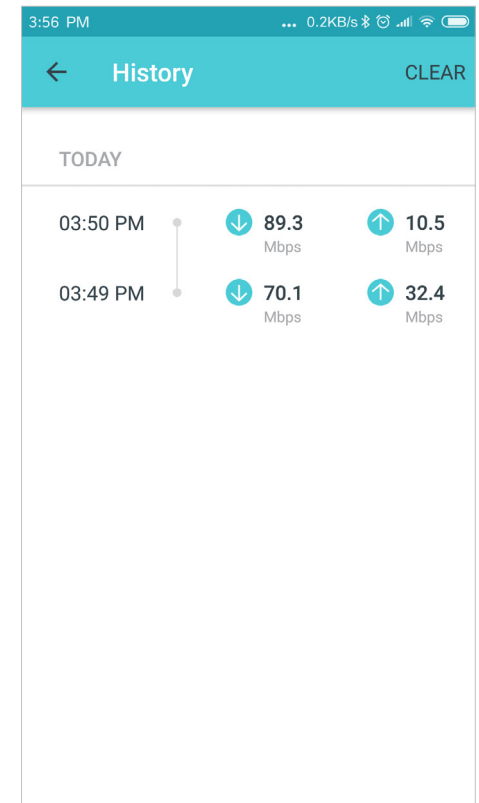

# Network Optimization

Network Optimization lets your Deco intelligently scan for a clearer channel and switch your devices to it, ensuring optimal Wi-Fi performance.

Tap  > [Network Optimization](#)

The app will scan the network automatically

Optimize your network for optimal Wi-Fi performance

Enjoy your time if your network status is perfect

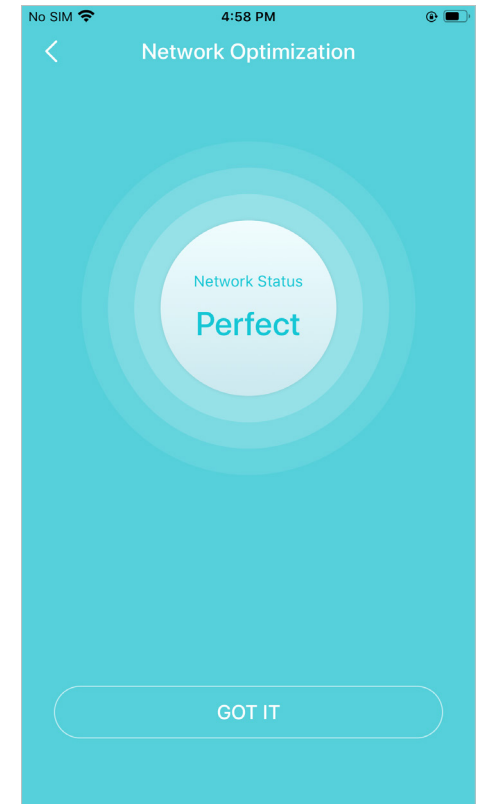
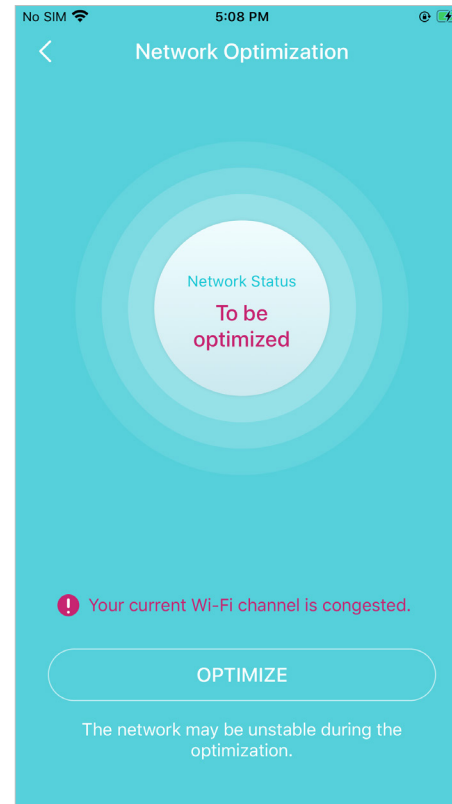
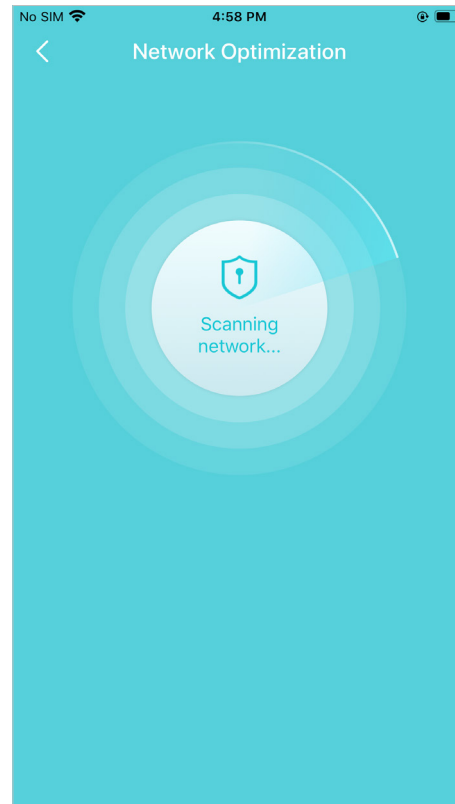
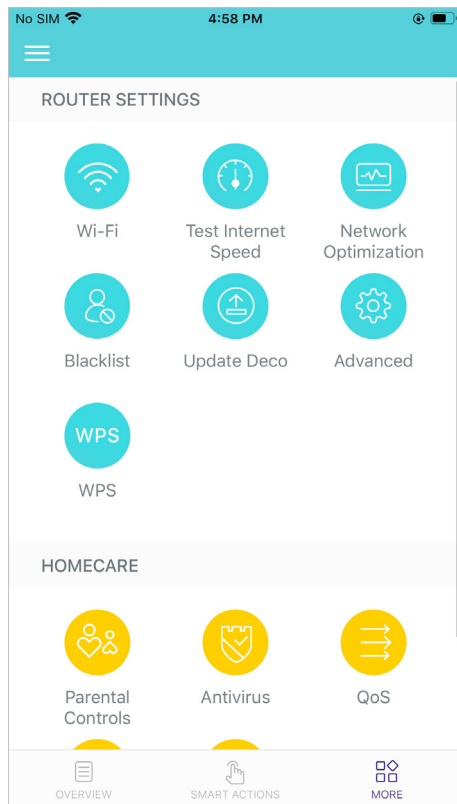

# Blacklist

Compile a blacklist to avoid devices added on the blacklist to access to your network, ensuring the safety of your personal information shared in the network.

Tap  > [Blacklist](#)

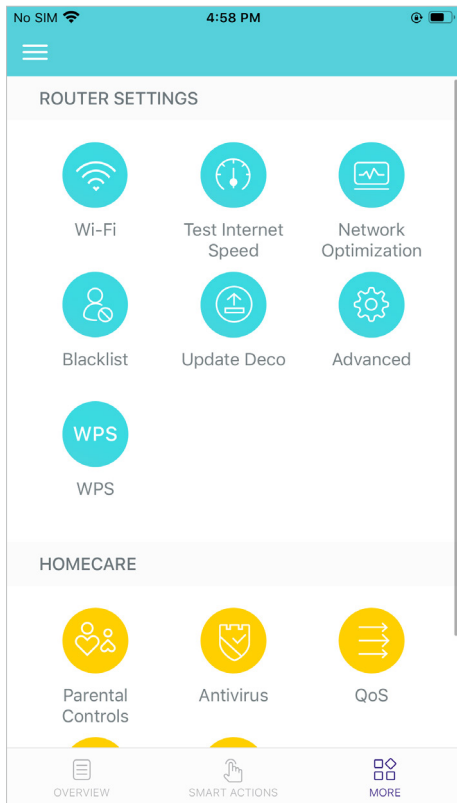

Add clients to blacklist

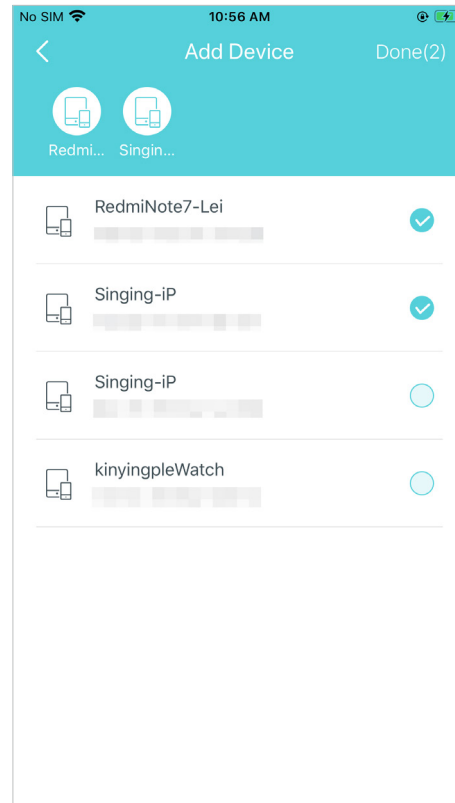

Add other devices to blacklist

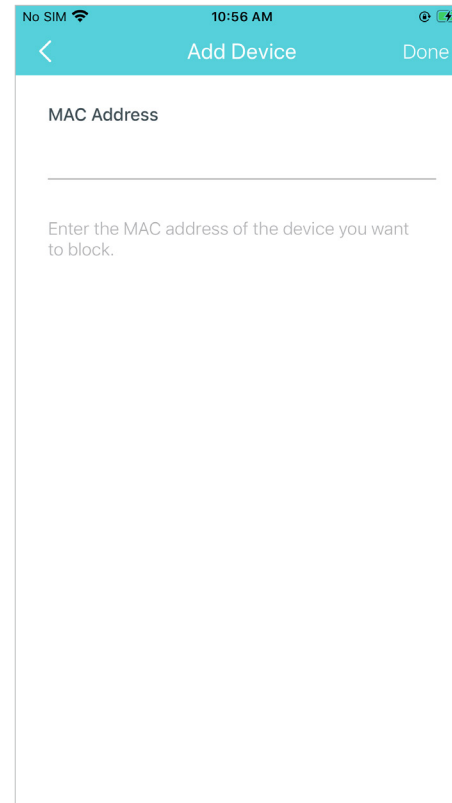

Manage blacklist

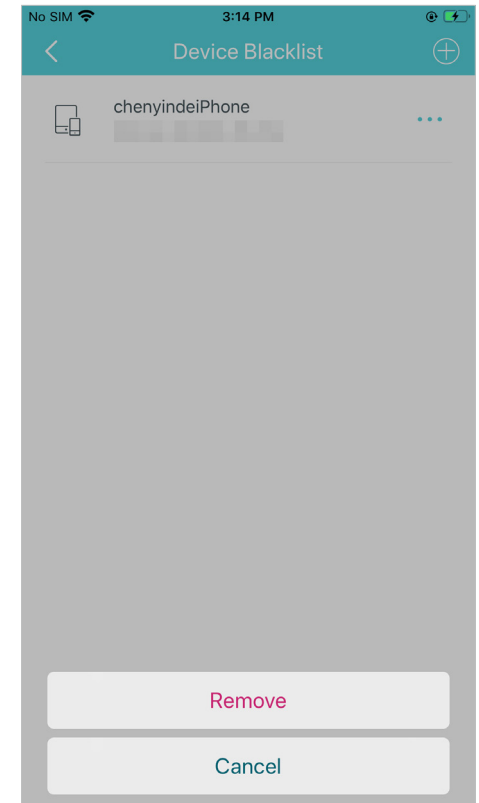

# Online Upgrade

TP-Link is dedicated to improving product features and providing a better customer experience. An up-to-date firmware provides better and more stable network performance. Always update your Deco to the latest firmware version when prompted in the Deco app.

Tap  > [Update Deco](#)

Follow app instructions to update your Deco to the latest version

 Tip: If the firmware update fails, please reboot the main Deco, move the Satellite Deco closer to the main Deco, then try to update again.

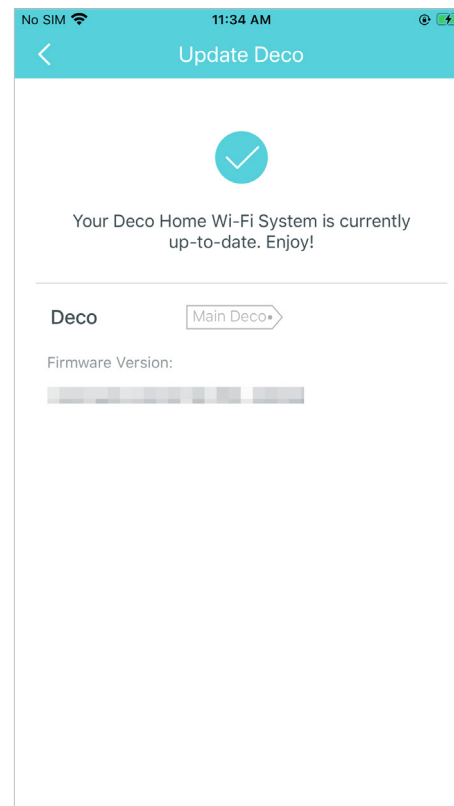
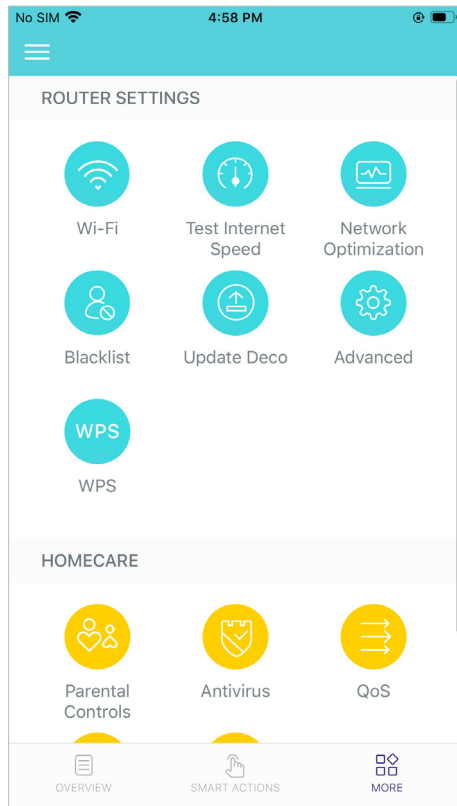

# WPS

WPS (Wi-Fi Protected Setup) helps you to quickly and securely connect a client to a network with a tap without entering any password.

Tap  > WPS

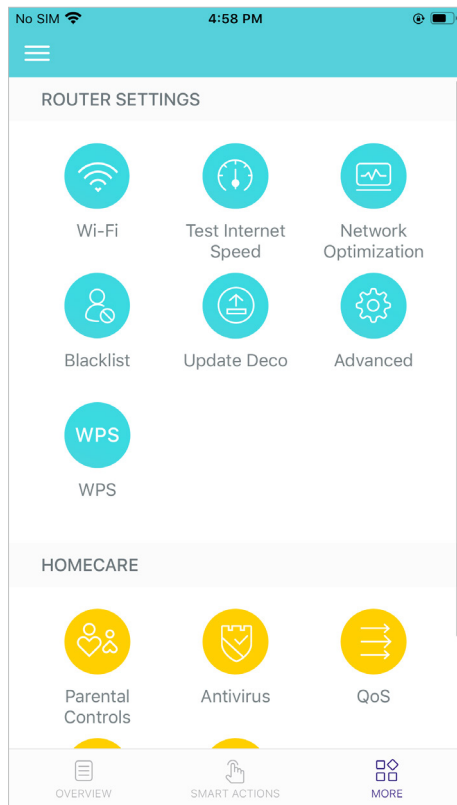

Tap the **WPS** icon on Deco app and then on your client

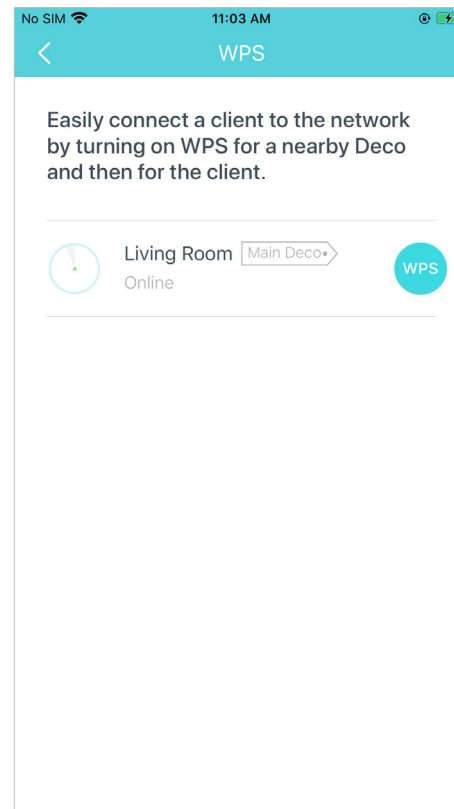

Your device connects to the network successfully if shown as below

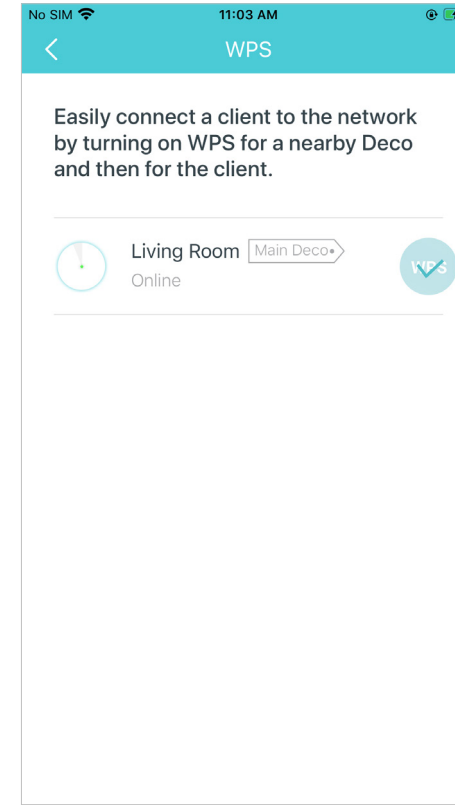

# Parental Controls

Parental Controls allows you to filter content, limit time spent online and check internet history. Start by creating unique profiles for your family members.

Tap  > Parental Controls

Create unique profiles for family members

Set filter level to block inappropriate contents

Set daily time limits for the total time spent online

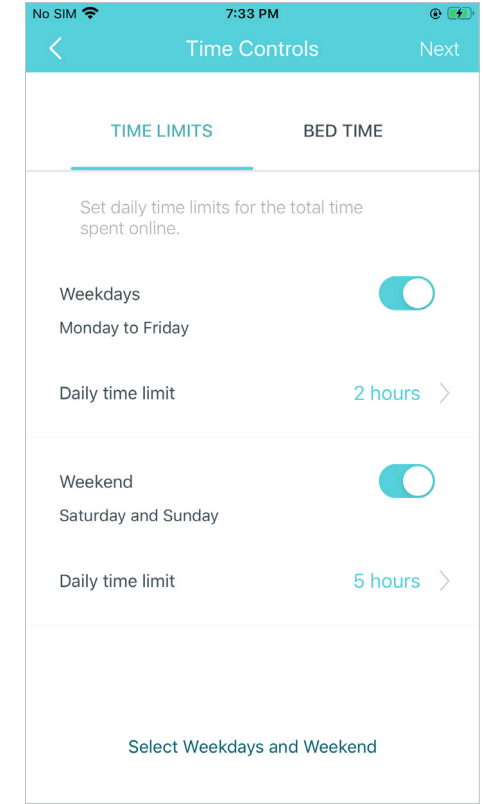
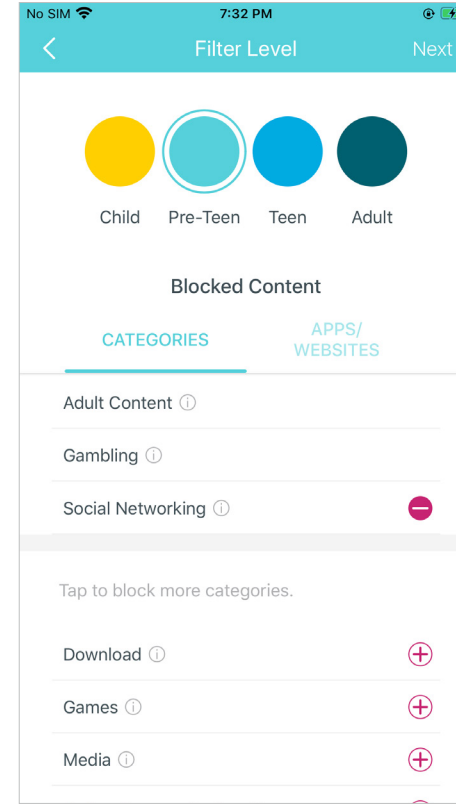
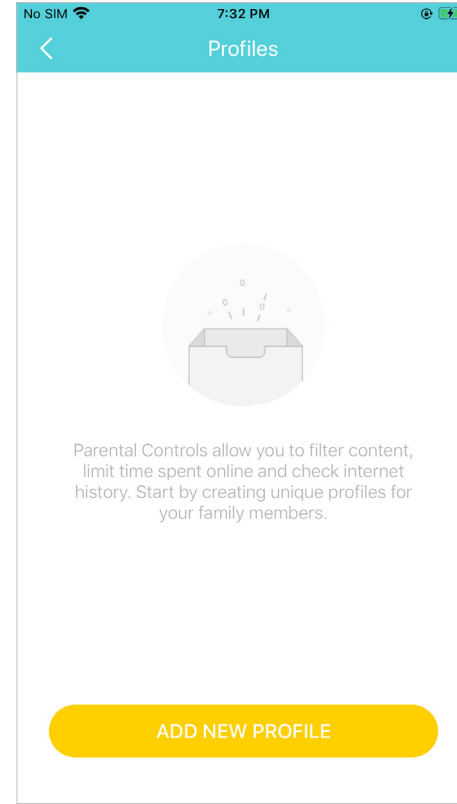
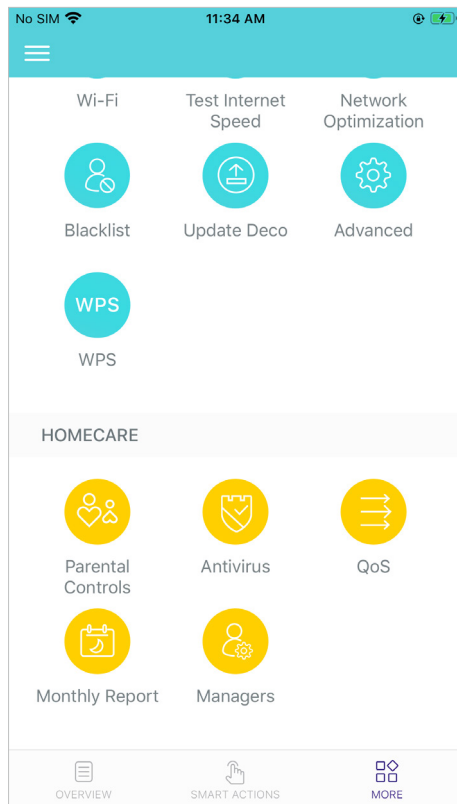



# Antivirus

Deco's Antivirus feature blocks malicious websites to ensure you can safely surf the internet, protects your network against external attacks and eliminates vulnerabilities, and prevents infected devices from sending sensitive information or security threats to devices outside your network. Enable them all to keep your network safe all the time.

Tap  > Antivirus

Enable the Antivirus features as needed

Add a website to Whitelist that will not be blocked.

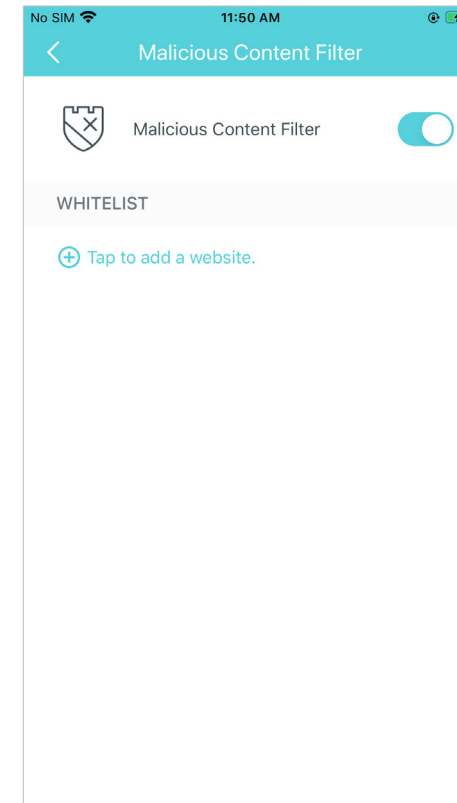
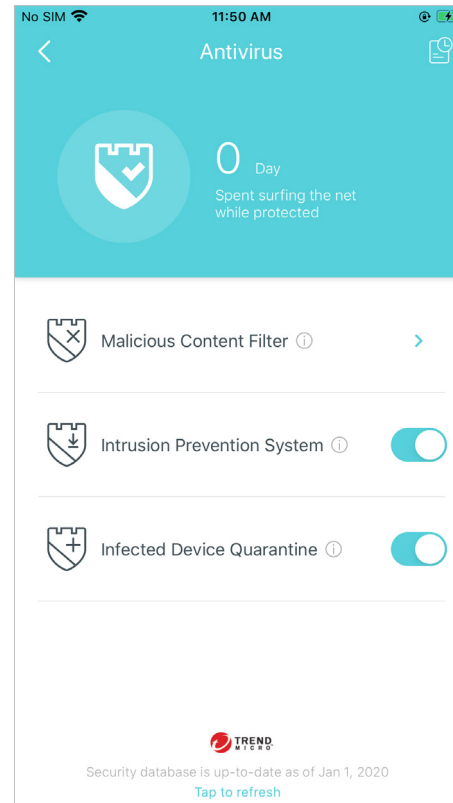
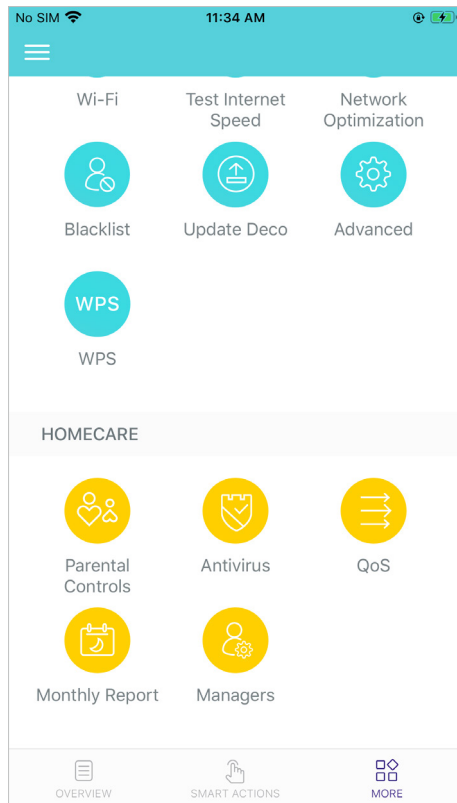

# QoS

QoS (Quality of Service) helps you set priority for specific applications and devices, so that they can perform better with lower latency.

Tap  > QoS

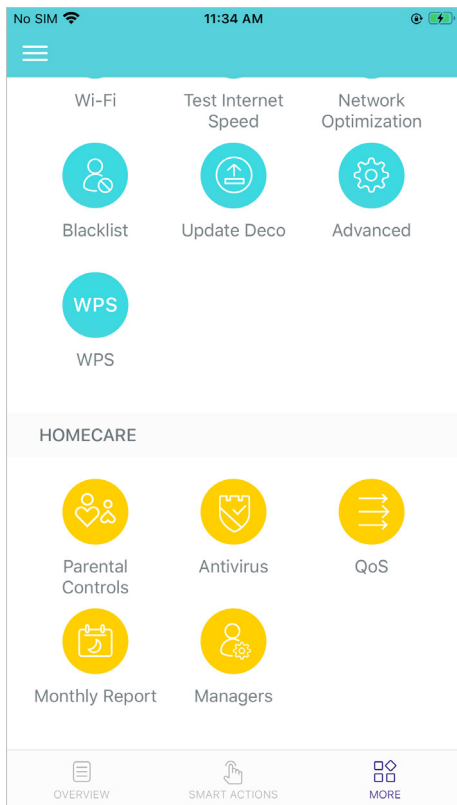

Set the total bandwidth before using QoS

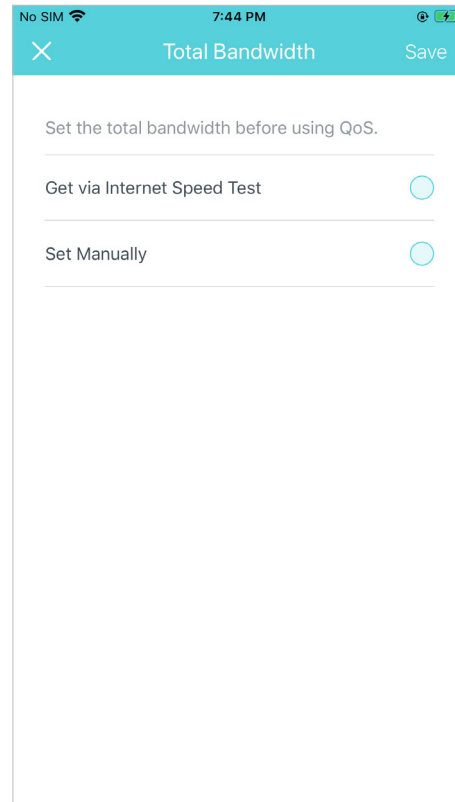

Tap to prioritize the online activity that's most important

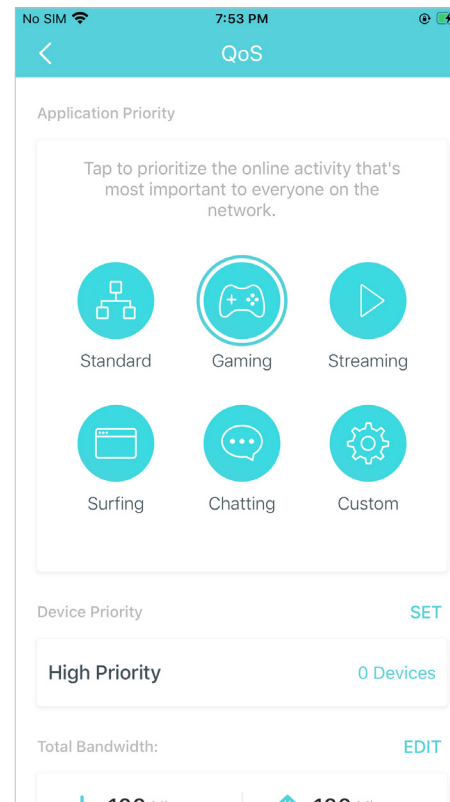

Add devices you want to prioritize to guarantee a better network performance

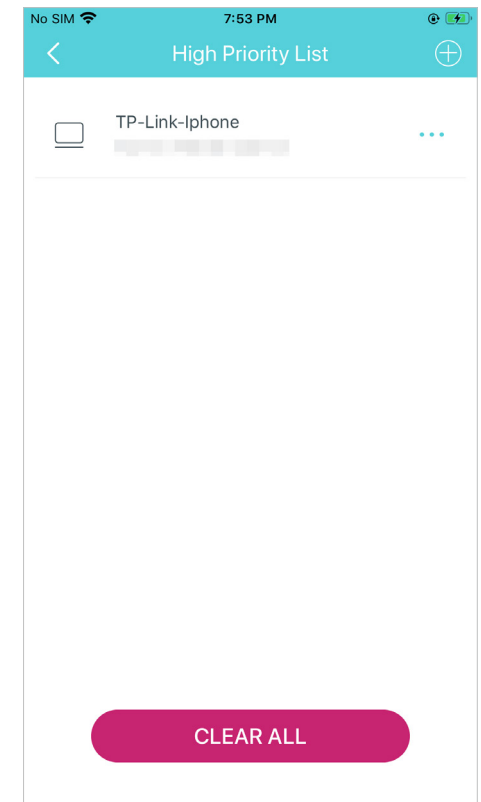

# Monthly Report

Review the monthly usage statistics, such as security threats and total connected network devices each day.

Tap  > Monthly Report

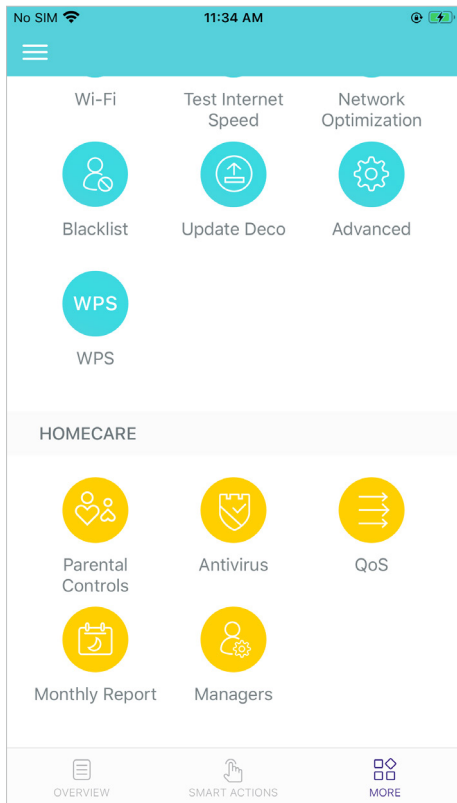

View monthly reports

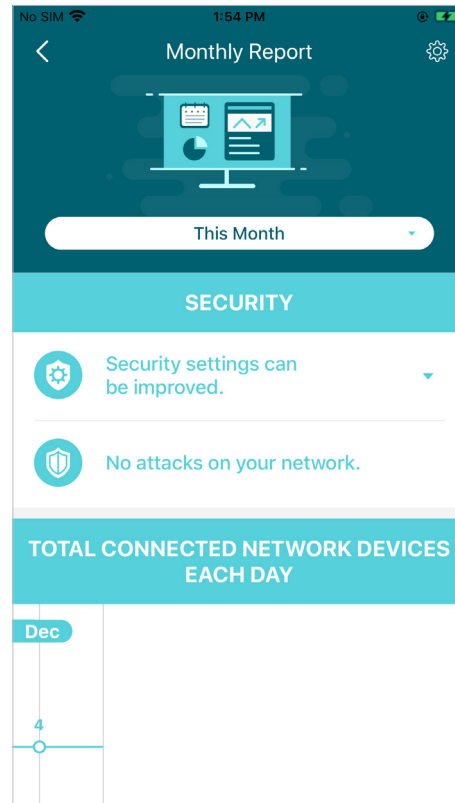

Enable or disable monthly report

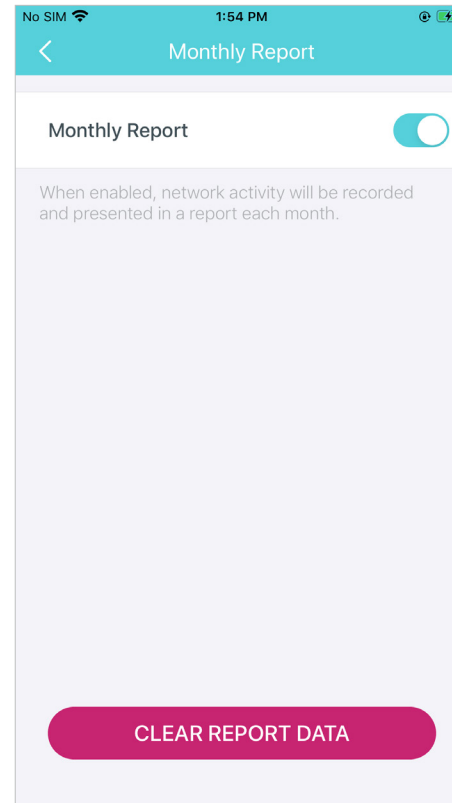

Clear monthly report data

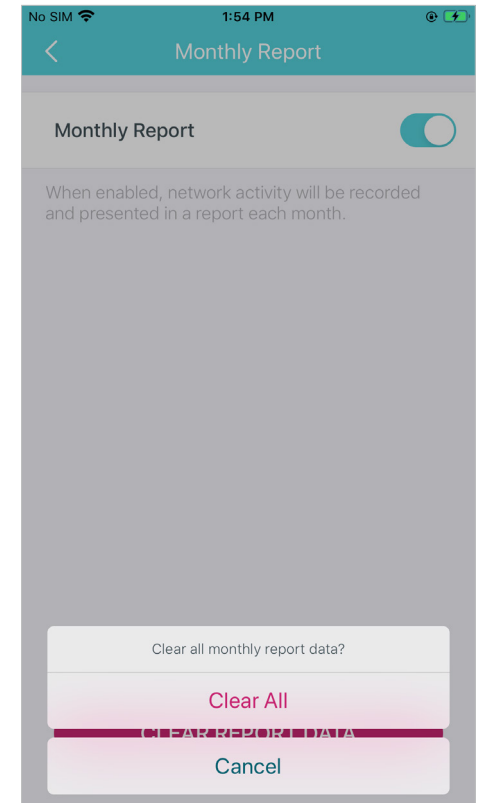

# Managers

Add friends and family members to help manage your network. Each manager should have their own TP-Link ID.

Tap  > Managers

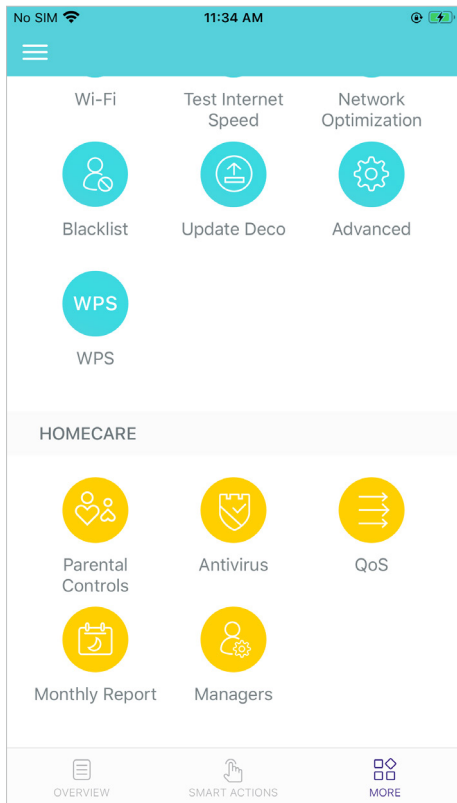

Add other accounts as managers

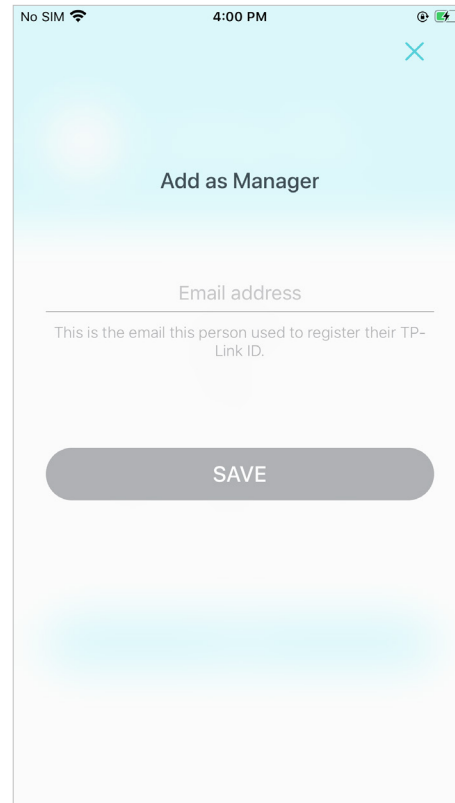

Set privileges for managers

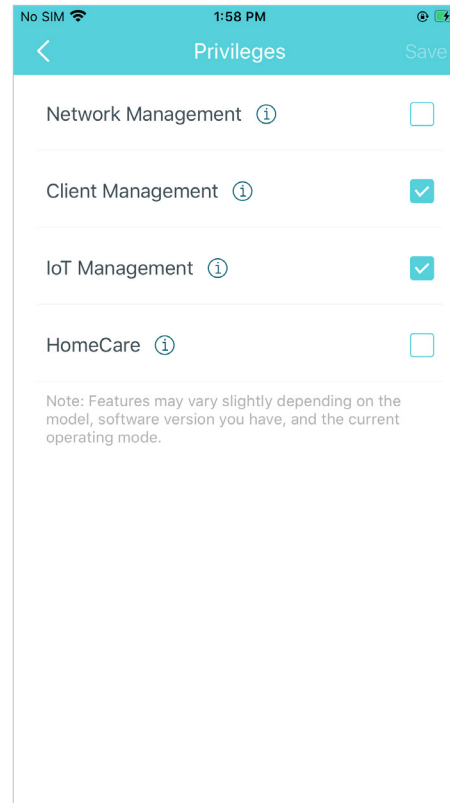

Remove manager

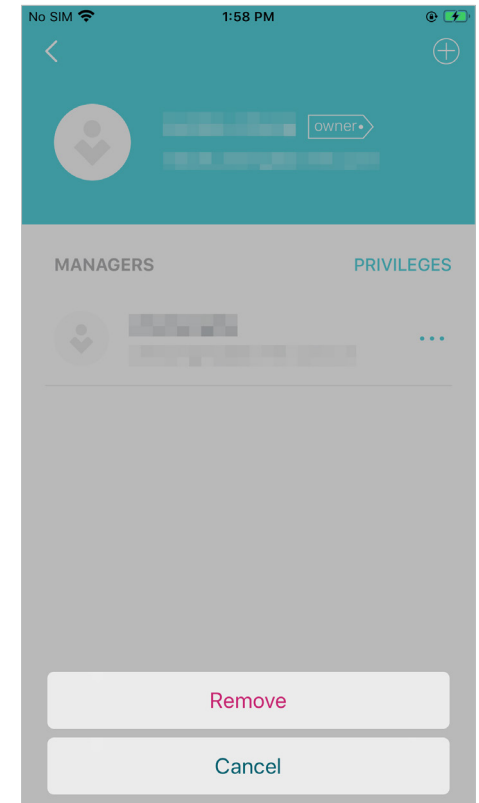

# Advanced Features

Additional features are available under the Advanced menu. You can modify WAN settings (IPv4 & IPv6), add IPv6 firewall rules, modify LAN IP, set up DHCP server, enable VLAN/IPTV/MAC Clone mode, reserve the same IP address for a specific device, set up port forwarding rules to make your local computers accessible to other devices over the internet, enable TP-Link DDNS, SIP ALG, fast roaming and beamforming, control Deco's LED, change the working mode, and configure the notification settings.

Tap  > [Advanced](#)

View IPv4 details or change the internet connection type

Enable IPv6 to set up an IPv6 internet connection

Add IPv6 firewall rules to allow specific devices to access the specified services

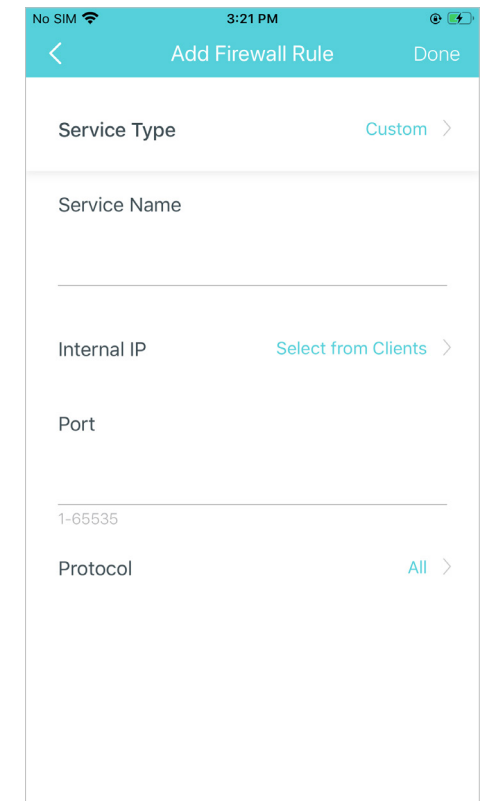
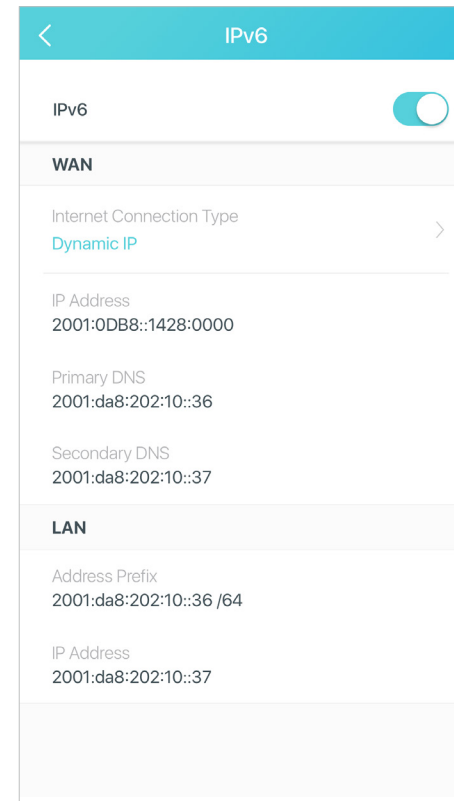
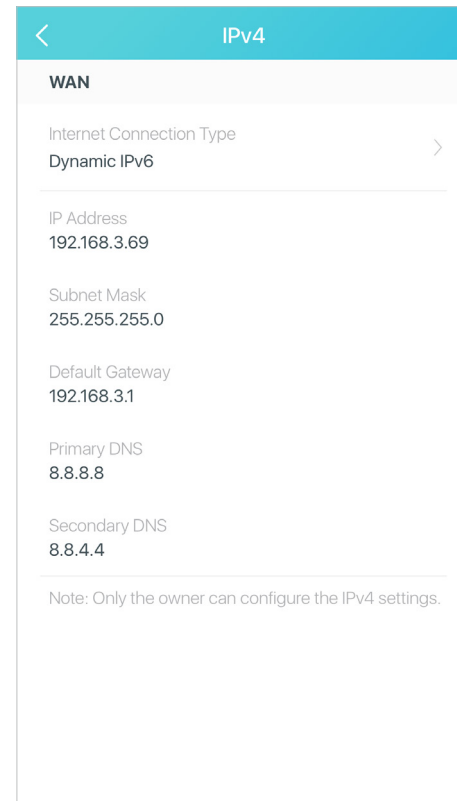
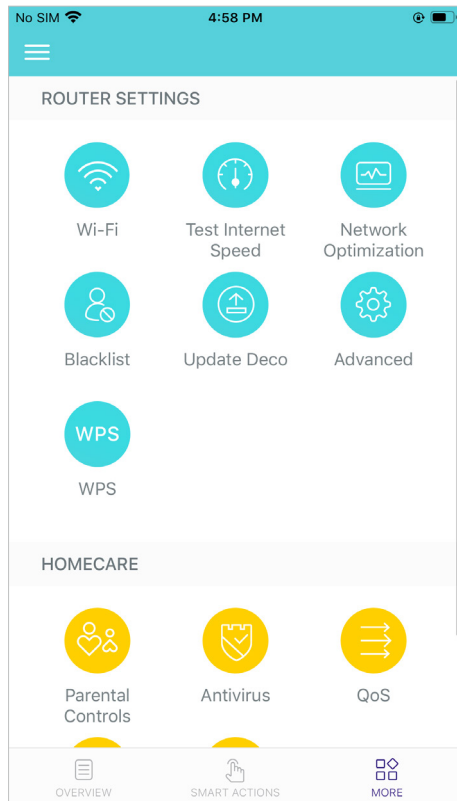

Modify LAN IP to avoid IP address conflict

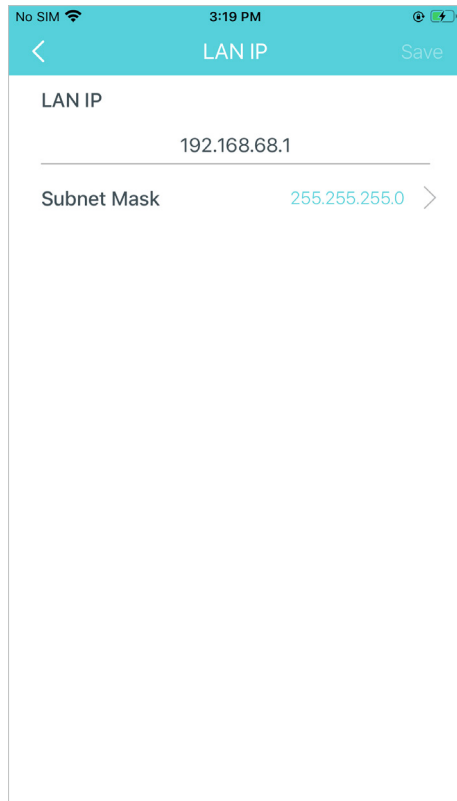

Change DHCP server settings

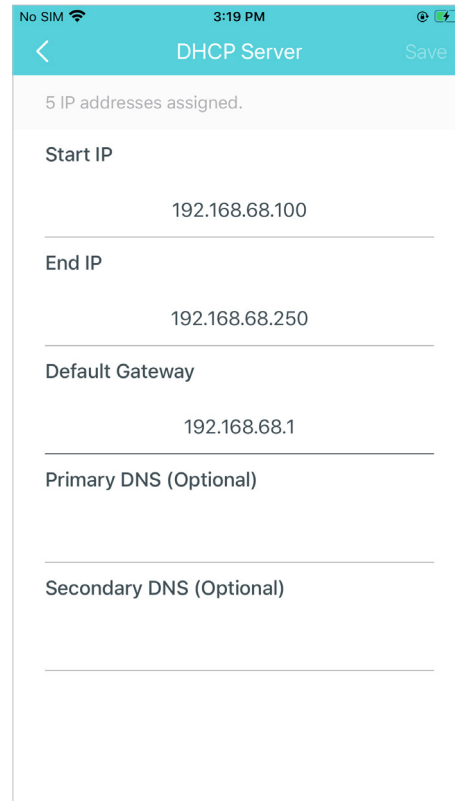

Enable IPTV/VLAN mode to support IPTV services

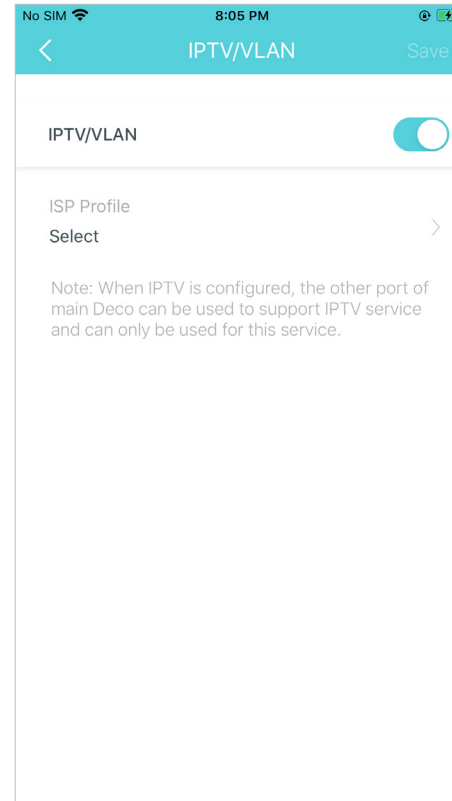

Enable MAC Clone if Deco fails to connect to the internet

Tip: For more about MAC Clone, refer to <https://www.tp-link.com/support/faq/2925/>

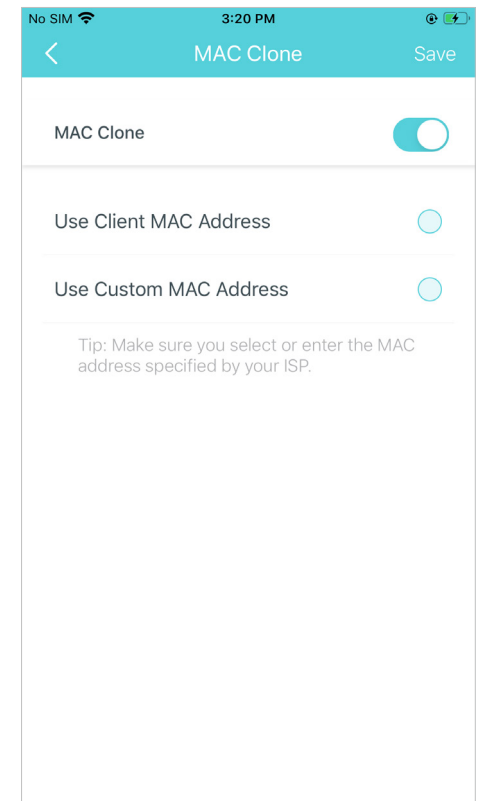

Reserve IP addresses for specific devices to recognize and manage the device more easily

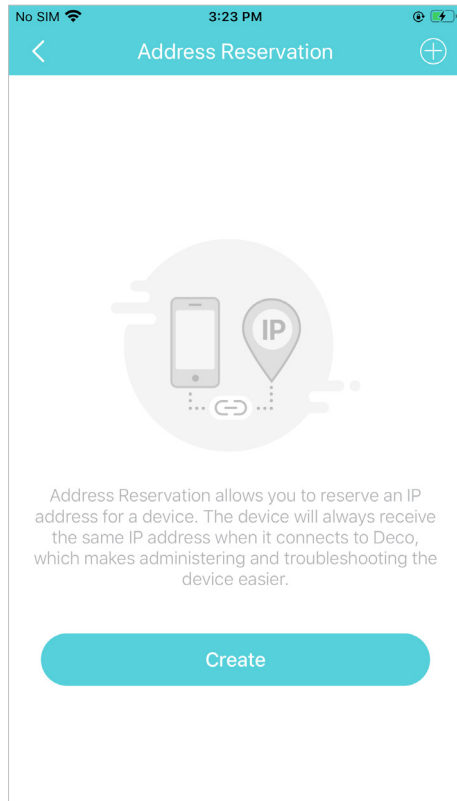

Set up port forwarding rules to enable devices in your network accessible over the internet with safety

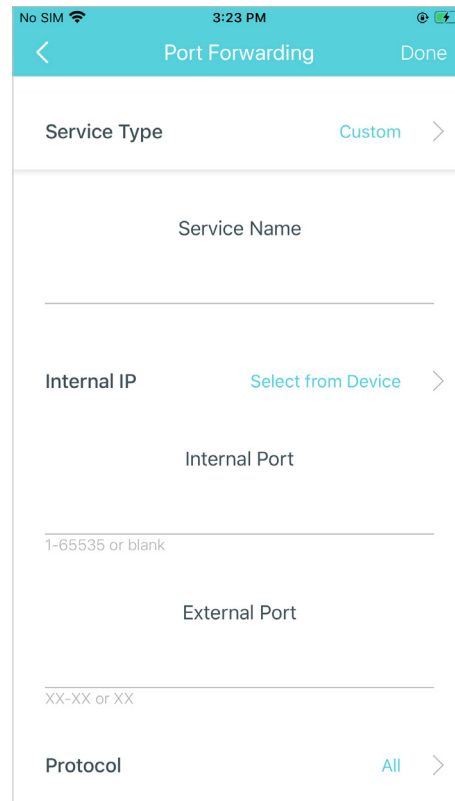

Register a TP-Link DDNS domain name to access your router and local servers using a domain name

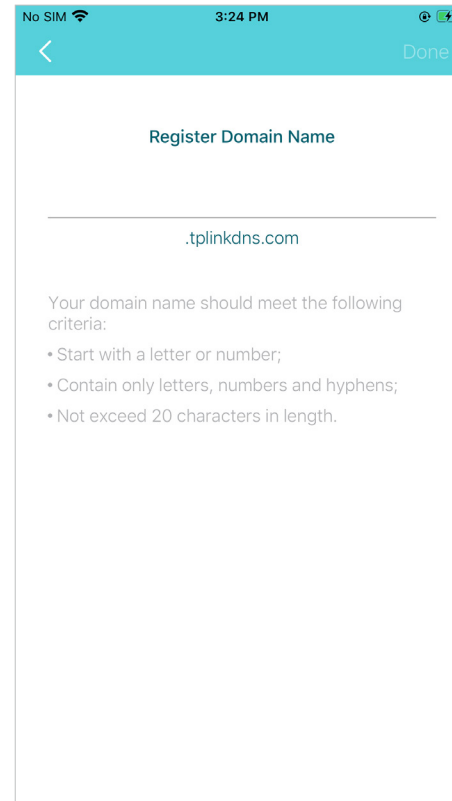

Enable SIP ALG to communicate with SIP (Session Initiation Protocol) servers via NAT

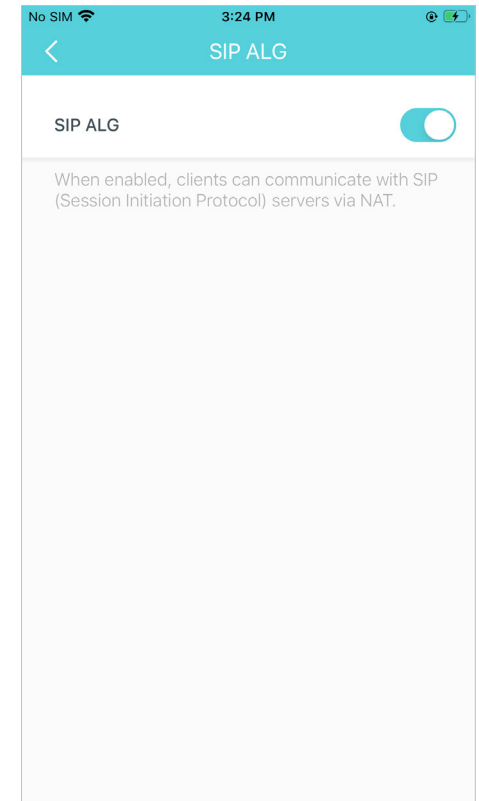

Enable UPNP to enable devices on your local network to dynamically open ports for applications such as multiplayer gaming

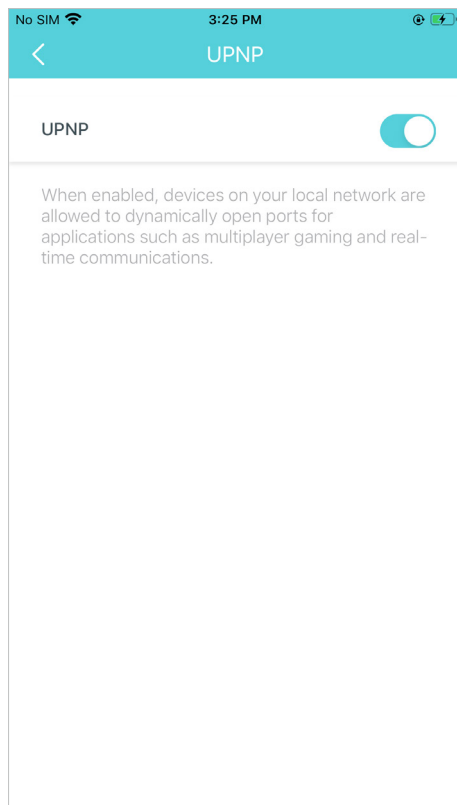

Enable Fast Roaming to allow your wireless devices to switch connection to different Decos seamlessly

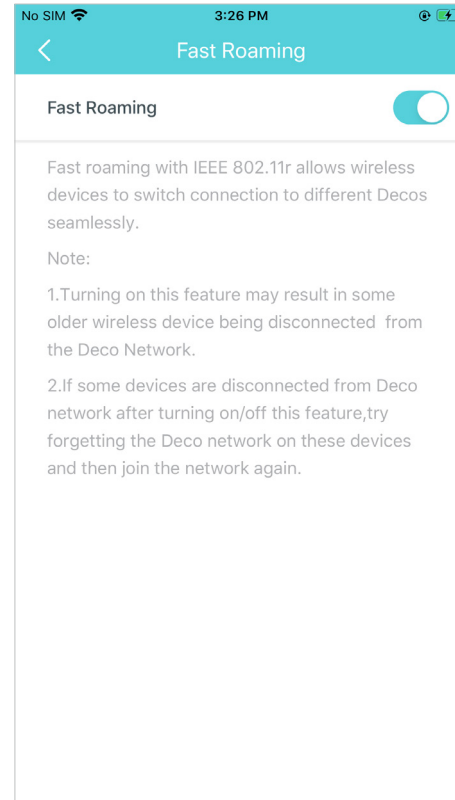

Enable Beamforming to concentrate Wi-Fi signal towards connected devices for stronger connections

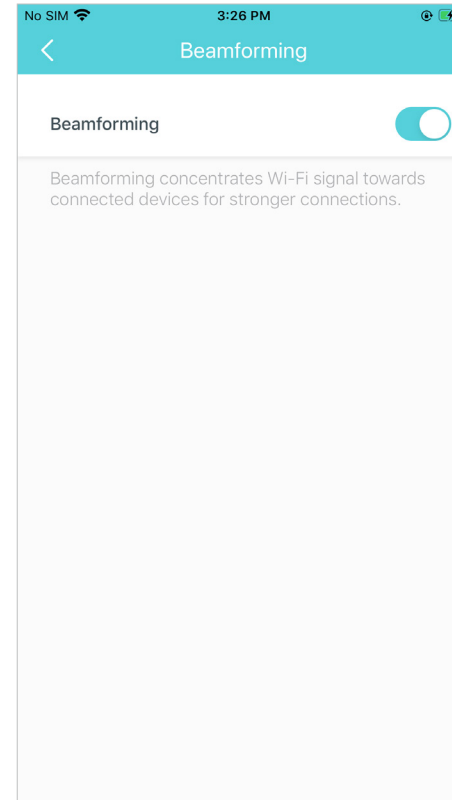

Toggle off LED to turn off the light on Deco. Configure the Night Mode to turn off the LED light at bedtime only

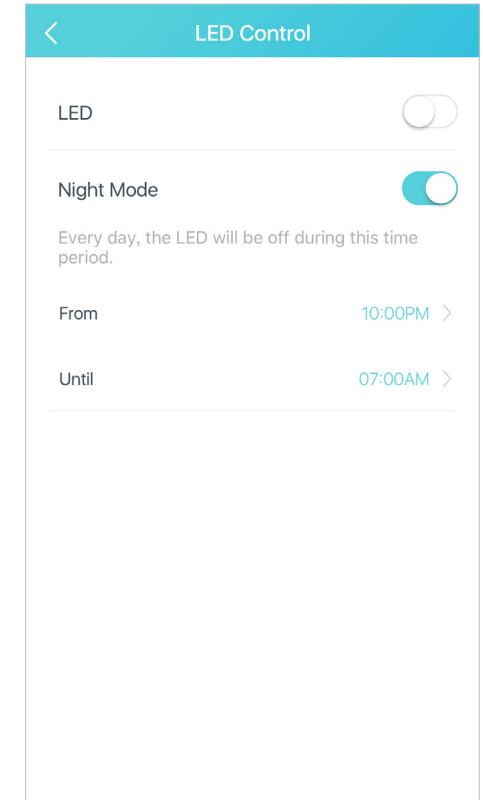



## Change the operating mode

**Note:** When the Deco works in Access Point mode, advanced features such as IPv4, Address Reservation, Port Forwarding, and DHCP server are not available.

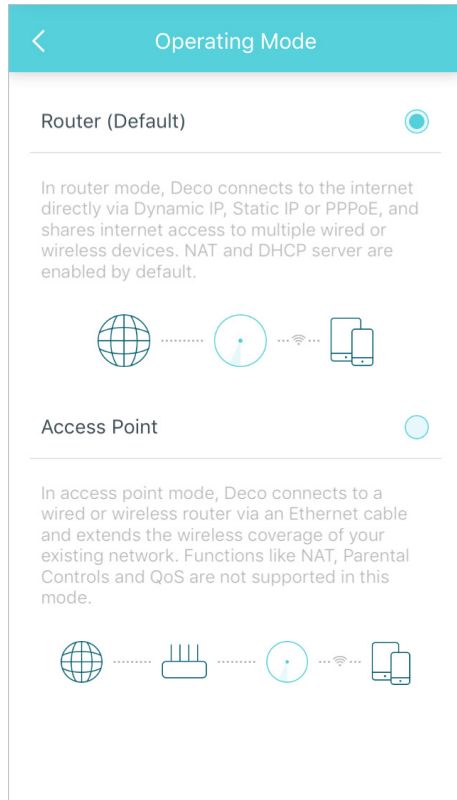

## Set connection alerts to receive notifications once the clients connect to or disconnect from Deco

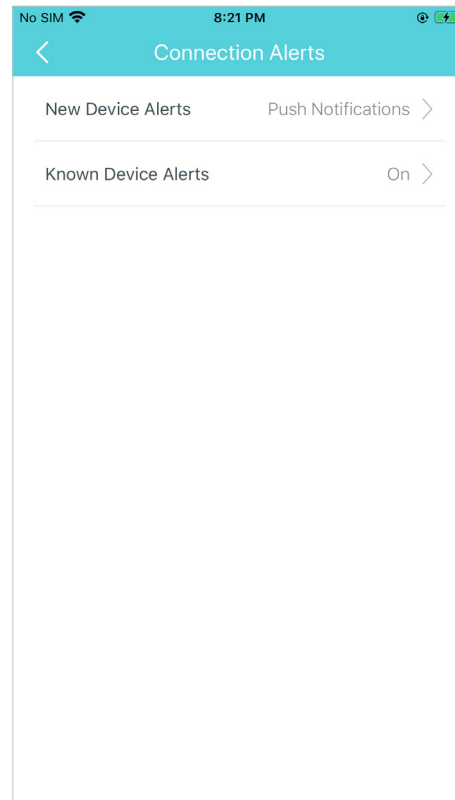

## Set notifications to receive alerts in the notification bar

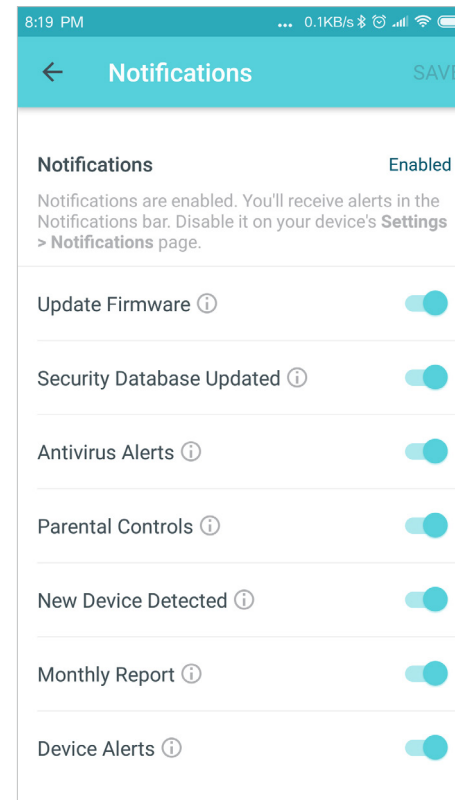

# Authentication

## FCC STATEMENT



**Product Name:** AC2200 Smart Home Mesh Wi-Fi System

**Model Number:** Deco M9 Plus

Component Name	Model
I.T.E POWER SUPPLY	T120200-2B4

### Responsible party:

**TP-Link USA Corporation, d/b/a TP-Link North America, Inc.**

Address: 145 South State College Blvd. Suite 400, Brea, CA 92821

Website: <http://www.tp-link.com/us/>

Tel: +1 626 333 0234

Fax: +1 909 527 6803

E-mail: [sales.usa@tp-link.com](mailto:sales.usa@tp-link.com)

This equipment has been tested and found to comply with the limits for a Class B digital device, pursuant to part 15 of the FCC Rules. These limits are designed to provide reasonable protection against harmful interference in a residential installation. This equipment generates, uses and can radiate radio frequency energy and, if not installed and used in accordance with the instructions, may cause harmful interference to radio communications. However, there is no guarantee that interference will not occur in a particular installation. If this equipment does cause harmful interference to radio or television reception, which can be determined by turning the equipment off and on, the user is encouraged to try to correct the interference by one or more of the following measures:

- Increase the separation between the equipment and receiver.
- Connect the equipment into an outlet on a circuit different from that to which the receiver is connected.

This device complies with part 15 of the FCC Rules. Operation is subject to the following two conditions:

1. This device may not cause harmful interference.
2. This device must accept any interference received, including interference that may cause undesired operation.

Any changes or modifications not expressly approved by the party responsible for compliance could void the user's authority to operate the equipment.

Note: The manufacturer is not responsible for any radio or TV interference caused by unauthorized modifications to this equipment. Such modifications could void the user's authority to operate the equipment.

### **FCC RF Radiation Exposure Statement**

This equipment complies with FCC RF radiation exposure limits set forth for an uncontrolled environment. This device and its antenna must not be co-located or operating in conjunction with any other antenna or transmitter.

"To comply with FCC RF exposure compliance requirements, this grant is applicable to only Mobile Configurations. The antennas used for this transmitter must be installed to provide a separation distance of at least 20 cm from all persons and must not be co-located or operating in conjunction with any other antenna or transmitter."

We, TP-Link USA Corporation, has determined that the equipment shown as above has been shown to comply with the applicable technical standards, FCC part 15. There is no unauthorized change is made in the equipment and the equipment is properly maintained and operated.

Issue Date:2021-06-23

### **FCC compliance information statement**



**Product Name:** I.T.E POWER SUPPLY

**Model Number:** T120200-2B4

**Responsible party:**

**TP-Link USA Corporation, d/b/a TP-Link North America, Inc.**

Address: 145 South State College Blvd. Suite 400, Brea, CA 92821

Website: <http://www.tp-link.com/us/>

Tel: +1 626 333 0234

Fax: +1 909 527 6803

E-mail: sales.usa@tp-link.com

This equipment has been tested and found to comply with the limits for a Class B digital device, pursuant to part 15 of the FCC Rules. These limits are designed to provide reasonable protection against harmful interference in a residential installation. This equipment generates, uses and can radiate radio frequency energy and, if not installed and used in accordance with the instructions, may cause harmful interference to radio communications. However, there is no guarantee that interference will not occur in a particular installation. If this equipment does cause harmful interference to radio or television reception, which can be determined by turning the equipment off and on, the user is encouraged to try to correct the interference by one or more of the following measures:

- Increase the separation between the equipment and receiver.
- Connect the equipment into an outlet on a circuit different from that to which the receiver is connected.
- Consult the dealer or an experienced radio/ TV technician for help.

This device complies with part 15 of the FCC Rules. Operation is subject to the following two conditions:

1. This device may not cause harmful interference.
2. This device must accept any interference received, including interference that may cause undesired operation.

Any changes or modifications not expressly approved by the party responsible for compliance could void the user's authority to operate the equipment.

We, TP-Link USA Corporation, has determined that the equipment shown as above has been shown to comply with the applicable technical standards, FCC part 15. There is no unauthorized change is made in the equipment and the equipment is properly maintained and operated.

Issue Date:2021-06-23

### CE Mark Warning



This is a class B product. In a domestic environment, this product may cause radio interference, in which case the user may be required to take adequate measures.

### OPERATING FREQUENCY(the maximum transmitted power)

- Wi-Fi: 2412MHz-2472MHz(20dBm) 5150MHz-5250MHz(23dBm) 5470MHz-5725MHz(except for 5600MHz-5650MHz)(30dBm)

- Bluetooth: 2402MHz-2480MHz(10dBm)
- Zigbee: 2405MHz-2480MHz(12dBm)

## **EU declaration of conformity**

TP-Link hereby declares that the device is in compliance with the essential requirements and other relevant provisions of directives 2014/53/EU, 2009/125/EC, 2011/65/EU and (EU)2015/863.

The original EU declaration of conformity may be found at <https://www.tp-link.com/en/ce>

## **RF Exposure Information**

This device meets the EU requirements (2014/53/EU Article 3.1a) on the limitation of exposure of the general public to electromagnetic fields by way of health protection.

The device complies with RF specifications when the device used at 20 cm from your body.

## **Canadian Compliance Statement**

This device complies with Industry Canada license-exempt RSS standard(s). Operation is subject to the following two conditions:

1. This device may not cause interference, and
2. This device must accept any interference, including interference that may cause undesired operation of the device.

Le présent appareil est conforme aux CNR d'Industrie Canada applicables aux appareils radio exempts de licence. L'exploitation est autorisée aux deux conditions suivantes :

1. l'appareil ne doit pas produire de brouillage;
2. l'utilisateur de l'appareil doit accepter tout brouillage radioélectrique subi, même si le brouillage est susceptible d'en compromettre le fonctionnement

## **Caution:**

The device for operation in the band 5150–5250 MHz is only for indoor use to reduce the potential for harmful interference to co-channel mobile satellite systems.

DFS (Dynamic Frequency Selection) products that operate in the bands 5470-5600MHz, and 5650-5725MHz.

## **Avertissement:**

Le dispositif fonctionnant dans la bande 5150-5250 MHz est réservé uniquement pour une utilisation à l'intérieur afin de réduire les risques de brouillage préjudiciable aux systèmes de satellites mobiles utilisant les mêmes canaux.

Les produits utilisant la technique d'atténuation DFS (sélection dynamique des fréquences) sur les bandes 5470-5600MHz et 5650-5725MHz.

## **Radiation Exposure Statement:**

This equipment complies with IC radiation exposure limits set forth for an uncontrolled environment. This equipment should be installed and operated with minimum distance 20cm between the radiator & your body.

## **Déclaration d'exposition aux radiations:**

Cet équipement est conforme aux limites d'exposition aux rayonnements IC établies pour un environnement non contrôlé. Cet équipement doit être installé et utilisé avec un minimum de 20 cm de distance entre la source de rayonnement et votre corps.

## **Industry Canada Statement**

CAN ICES-3 (B)/NMB-3(B)

## **Korea Warning Statements:**

당해 무선설비는 운용중 전파혼신 가능성이 있음.

## **NCC Notice & BSMI Notice:**

注意!

依據 低功率電波輻射性電機管理辦法

LP0002低功率射頻器材技術規範\_章節3.8.2

取得審驗證明之低功率射頻器材，非經核准，公司、商號或使用者均不得擅自變更頻率、加大功率或變更原設計之特性及功能。

低功率射頻器材之使用不得影響飛航安全及干擾合法通信；經發現有干擾現象時，應立即停用，並改善至無干擾時方得繼續使用。

前述合法通信，指依電信管理法規定作業之無線電通信。

低功率射頻器材須忍受合法通信或工業、科學及醫療用電波輻射性電機設備之干擾。

5.7.9.1應避免影響附近雷達系統之操作。

安全諮詢及注意事項

- 請使用原裝電源供應器或只能按照本產品注明的電源類型使用本產品。
- 清潔本產品之前請先拔掉電源線。請勿使用液體、噴霧清潔劑或濕布進行清潔。
- 注意防潮，請勿將水或其他液體潑灑到本產品上。
- 插槽與開口供通風使用，以確保本產品的操作可靠並防止過熱，請勿堵塞或覆蓋開口。
- 請勿將本產品置放於靠近熱源的地方。除非有正常的通風，否則不可放在密閉位置中。
- 不要私自拆開機殼或自行維修，如產品有故障請與原廠或代理商聯繫作。

限用物質含有情況標示聲明書

設備名稱： Equipment name: <b>AC2200 Smart Home Mesh Wi-Fi System</b>		型號（型式）： Type designation (Type) <b>Deco M9 Plus</b>				
單元 Unit	限用物質及其化學符號 Restricted substances and its chemical symbols					
	鉛 Lead (Pb)	汞 Mercury (Hg)	鎘 Cadmium (Cd)	六價鉻 Hexavalent chromium (Cr <sup>+6</sup> )	多溴聯苯 Polybrominated biphenyls (PBB)	多溴二苯醚 Polybrominated diphenyl ethers (PBDE)
PCB	○	○	○	○	○	○
外殼	○	○	○	○	○	○
電源供應器	—	○	○	○	○	○
其他及其配件	—	○	○	○	○	○

備考1. 超出0.1 wt %” 及 “超出0.01 wt %” 系指限用物質之百分比含量超出百分比含量基準值。

Note 1: “Exceeding 0.1 wt %” and “exceeding 0.01 wt %” indicate that the percentage content of the restricted substance exceeds the reference percentage value of presence condition.

備考2. “○” 系指該項限用物質之百分比含量未超出百分比含量基準值。

Note 2: “○” indicates that the percentage content of the restricted substance does not exceed the percentage of reference value of presence.

備考3. “—” 系指該項限用物質為排除項目。

Note 3: The “—” indicates that the restricted substance corresponds to the exemption.



Продукт сертифіковано згідно с правилами системи УкрСЕПРО на відповідність вимогам нормативних документів та вимогам, що передбачені чинними законодавчими актами України.



## Safety Information







- Keep the device away from water, fire, humidity or hot environments.
- Do not attempt to disassemble, repair, or modify the device. If you need service, please contact us.
- Do not use damaged charger or USB cable to charge the device.
- Do not use any other chargers than those recommended.
- Do not use the device where wireless devices are not allowed.
- Adapter shall be installed near the equipment and shall be easily accessible.
- Use only power supplies which are provided by manufacturer and in the original packing of this product. If you have any questions, please don't hesitate to contact us.
- Operating Temperature: 0°C ~40°C (32°F ~104°F)



- Storage Temperature: -40°C ~70°C (-40°F ~158°F)
- Operating Humidity: 10%~90% non-condensing
- Storage Humidity: 5%~90% non-condensing

Please read and follow the above safety information when operating the device. We cannot guarantee that no accidents or damage will occur due to improper use of the device. Please use this product with care and operate at your own risk.

### Explanation of the symbols on the product label

Symbol	Explanation
	DC voltage
	Indoor use only
	Operator's manual
	Polarity of output terminals
	Energy efficiency Marking
	<p>RECYCLING</p> <p>This product bears the selective sorting symbol for Waste electrical and electronic equipment (WEEE). This means that this product must be handled pursuant to European directive 2012/19/EU in order to be recycled or dismantled to minimize its impact on the environment.</p> <p>User has the choice to give his product to a competent recycling organization or to the retailer when he buys a new electrical or electronic equipment.</p>