

User's Guide

GS1920v2 Series

8/24/48-port GbE Smart Managed Switch

Default Login Details

Management IP Address	http://DHCP-assigned IP or 192.168.1.1
User Name	admin
Password	1234

Version 4.70 Edition 1, 09/2020

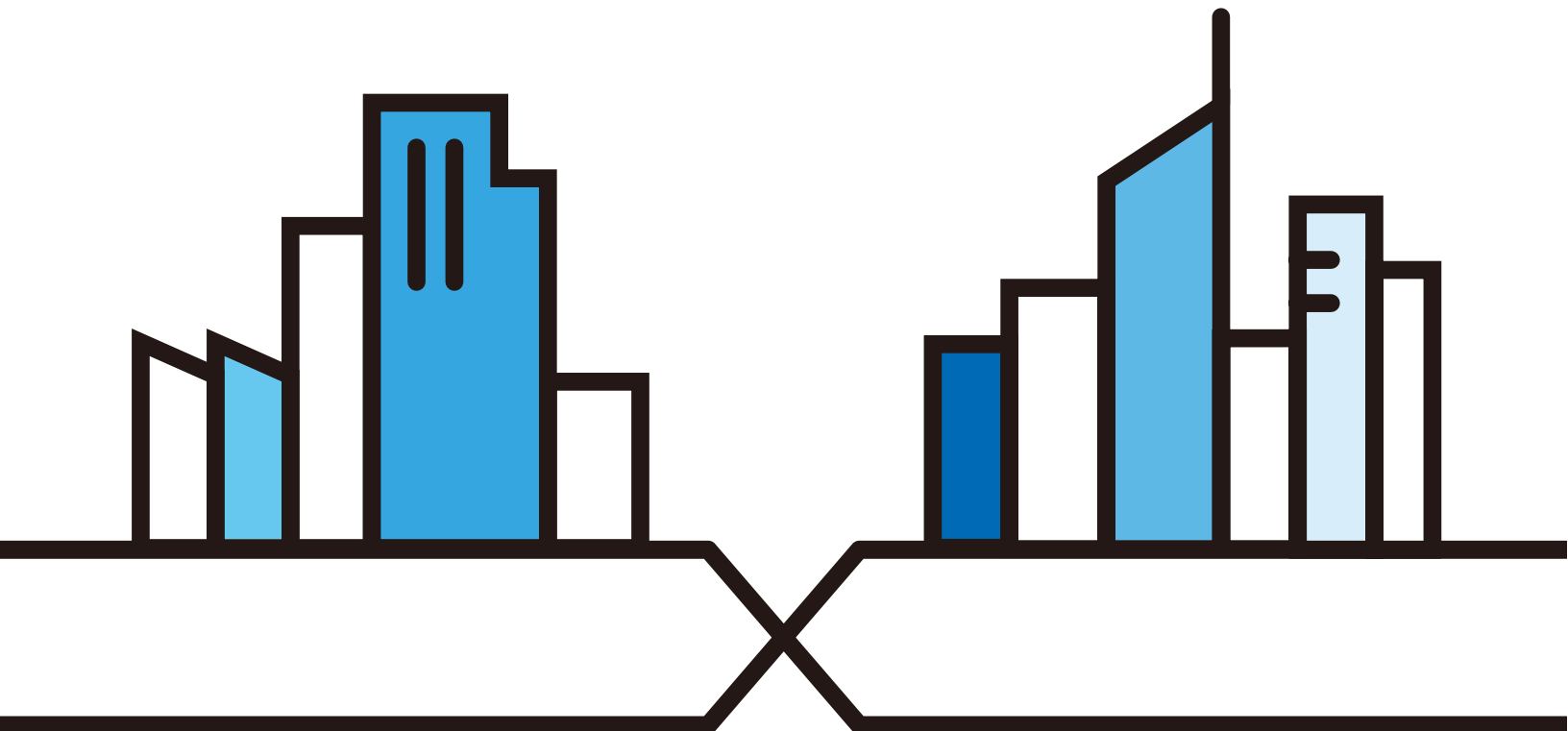

IMPORTANT!

READ CAREFULLY BEFORE USE.

KEEP THIS GUIDE FOR FUTURE REFERENCE.

This is a User's Guide for a series of products. Not all products support all firmware features. Screenshots and graphics in this book may differ slightly from your product due to differences in your product firmware or your computer operating system. Every effort has been made to ensure that the information in this manual is accurate.

Related Documentation

- Quick Start Guide
The Quick Start Guide shows how to connect the Switch.
- Online Help
Click the help link for a description of the fields in the Switch menus.
- Nebula Control Center (NCC) User's Guide
Go to <https://nebula.zyxel.com> or support.zyxel.com to get this User's Guide on how to configure the Switch using Nebula.
- More Information
Go to <https://businessforum.zyxel.com> for product discussions.
Go to support.zyxel.com to find other information on the Switch.



Document Conventions

Warnings and Notes

These are how warnings and notes are shown in this guide.

Warnings tell you about things that could harm you or your device.











Note: Notes tell you other important information (for example, other things you may need to configure or helpful tips) or recommendations.

Syntax Conventions

- All models may be referred to as the "Switch" in this guide.
- Product labels, screen names, field labels and field choices are all in **bold** font.
- A right angle bracket (>) within a screen name denotes a mouse click. For example, **Basic Setting > IP Setup > IP Configuration > Network Proxy Configuration** means you first click **Basic Setting** in the navigation panel, then the **IP Setup** sub menu, then **IP Configuration** and finally **Network Proxy Configuration** to get to that screen.

Icons Used in Figures

Figures in this user guide may use the following generic icons. The Switch icon is not an exact representation of your device.

Switch 	Generic Router 	Wireless Router / Access Point 
Generic Switch 	Smart TV 	Desktop 
Laptop 	IP Camera 	Printer 
Server 		

Contents Overview

User's Guide	20
Getting to Know Your Switch	21
Hardware Installation and Connection	29
Hardware Panels	36
Technical Reference	45
Web Configurator	46
Initial Setup Example	61
Tutorials	66
Status	75
Basic Setting	81
VLAN	114
Static MAC Forwarding	137
Static Multicast Forwarding	139
Filtering	143
Spanning Tree Protocol	145
Bandwidth Control	165
Broadcast Storm Control	167
Mirroring	169
Link Aggregation	171
Port Authentication	179
Port Security	189
Time Range	191
Classifier	193
Policy Rule	202
Queuing Method	206
Multicast	209
AAA	232
IP Source Guard	242
DHCP Snooping	246
ARP Inspection	256
Loop Guard	264
Layer 2 Protocol Tunneling	267
PPPoE	271
Error Disable	279
VLAN Isolation	286
Green Ethernet	288
Link Layer Discovery Protocol (LLDP)	290

OAM	313
Static Route	320
Differentiated Services	324
DHCP	328
ARP Setup	340
Maintenance	344
Access Control	357
Diagnostic	380
System Log	383
Syslog Setup	384
Cluster Management	387
MAC Table	393
ARP Table	396
Path MTU Table	398
Configure Clone	399
IPv6 Neighbor Table	402
Port Status	404
Troubleshooting and Appendices	412
Troubleshooting	413

Table of Contents

Document Conventions	3
Contents Overview	4
Table of Contents	6
Part I: User's Guide.....	20
Chapter 1	
Getting to Know Your Switch	21
1.1 Introduction	21
1.1.1 Mode Changing	22
1.1.2 ZON Utility	23
1.1.3 PoE	23
1.2 Example Applications	24
1.2.1 PoE Example Application	24
1.2.2 Backbone Example Application	25
1.2.3 Bridging or Fiber Uplink Example Application	25
1.2.4 High Performance Switching Example	26
1.2.5 IEEE 802.1Q VLAN Application Examples	26
1.3 Ways to Manage the Switch	27
1.4 Good Habits for Managing the Switch	27
Chapter 2	
Hardware Installation and Connection	29
2.1 Installation Scenarios	29
2.2 Safety Precautions	29
2.3 Desktop Installation Procedure	29
2.4 Desk Mounting (GS1920-8HPv2 Only)	30
2.4.1 Installation Requirements	30
2.4.2 Precautions	30
2.4.3 Attaching the Mounting Brackets to the Switch	31
2.4.4 Mounting the Switch under a Table	31
2.5 Wall Mounting (GS1920-8HPv2 Only)	32
2.5.1 Installation Requirements	32
2.6 Mounting the Switch on a Rack	33
2.6.1 Installation Requirements	34
2.6.2 Precautions	34

2.6.3 Attaching the Mounting Brackets to the Switch	34
2.6.4 Mounting the Switch on a Rack	34
Chapter 3	
Hardware Panels.....	36
3.1 Front Panel Connections	36
3.1.1 Ethernet Ports	36
3.1.2 PoE (GS1920-8HPv2 & GS1920-24HPv2 & GS1920-48HPv2)	37
3.1.3 SFP Slots	37
3.2 Rear Panel	40
3.2.1 Grounding	40
3.2.2 AC Power Connection	42
3.3 LEDs	42
Part II: Technical Reference.....	45
Chapter 4	
Web Configurator.....	46
4.1 Overview	46
4.2 System Login	46
4.3 Zyxel One Network (ZON) Utility	49
4.3.1 Requirements	49
4.3.2 Run the ZON Utility	49
4.4 Web Configurator Layout	53
4.4.1 Change Your Password	57
4.5 Save Your Configuration	58
4.6 Switch Lockout	58
4.7 Reset the Switch	59
4.7.1 Restore Custom Default	59
4.7.2 Reboot the Switch	59
4.8 Log Out of the Web Configurator	59
4.9 Help	59
Chapter 5	
Initial Setup Example	61
5.1 Overview	61
5.1.1 Create a VLAN	61
5.1.2 Set Port VID	63
5.1.3 Configure Switch Management IP Address	63
Chapter 6	
Tutorials	66

6.1 Overview	66
6.2 How to Use DHCPv4 Snooping on the Switch	66
6.3 How to Use DHCPv4 Relay on the Switch	70
6.3.1 DHCP Relay Tutorial Introduction	70
6.3.2 Create a VLAN	71
6.3.3 Configure DHCPv4 Relay	73
6.3.4 Troubleshooting	74
Chapter 7	
Status.....	75
7.1 Overview	75
7.1.1 What You Can Do	75
7.2 Status	75
7.2.1 Neighbor Screen	77
7.2.2 Neighbor Detail	79
Chapter 8	
Basic Setting	81
8.1 Overview	81
8.1.1 What You Can Do	81
8.2 System Information	81
8.3 General Setup	83
8.4 Introduction to VLANs	85
8.5 Switch Setup	86
8.6 IP Setup	87
8.6.1 IP Status	88
8.6.2 IP Status Details	88
8.6.3 IP Configuration	89
8.6.4 Network Proxy Configuration	91
8.7 Port Setup	92
8.8 PoE Status	94
8.8.1 PoE Time Range Setup	96
8.8.2 PoE Setup	97
8.9 Interface Setup	100
8.10 IPv6	101
8.10.1 IPv6 Status	101
8.10.2 IPv6 Interface Status	102
8.10.3 IPv6 Configuration	104
8.10.4 IPv6 Global Setup	105
8.10.5 IPv6 Interface Setup	105
8.10.6 IPv6 Link-Local Address Setup	106
8.10.7 IPv6 Global Address Setup	107
8.10.8 IPv6 Neighbor Discovery Setup	109

8.10.9 IPv6 Neighbor Setup	110
8.10.10 DHCPv6 Client Setup	111
8.11 Cloud Management	112
8.11.1 Nebula Center Control Discovery	112
8.11.2 Nebula Switch Registration	113
Chapter 9	
VLAN.....	114
9.1 Overview	114
9.1.1 What You Can Do	114
9.1.2 What You Need to Know	114
9.2 Introduction to IEEE 802.1Q Tagged VLANs	114
9.3 VLAN Status	117
9.3.1 VLAN Details	118
9.4 VLAN Configuration	119
9.5 Configure a Static VLAN	120
9.6 Configure VLAN Port Settings	121
9.7 Subnet Based VLANs	123
9.7.1 Configuring Subnet Based VLAN	124
9.8 Protocol Based VLANs	125
9.8.1 Configuring Protocol Based VLAN	126
9.9 Voice VLAN	127
9.10 MAC Based VLAN	129
9.11 Vendor ID Based VLAN	130
9.12 Port-Based VLAN Setup	132
9.12.1 Configure a Port-Based VLAN	132
9.13 Technical Reference	135
9.13.1 Create an IP-based VLAN Example	135
Chapter 10	
Static MAC Forwarding.....	137
10.1 Overview	137
10.1.1 What You Can Do	137
10.2 Configure Static MAC Forwarding	137
Chapter 11	
Static Multicast Forwarding.....	139
11.1 Overview	139
11.1.1 What You Can Do	139
11.1.2 What You Need To Know	139
11.2 Configure Static Multicast Forwarding	140
Chapter 12	
Filtering.....	143

12.1 Filtering Overview	143
12.1.1 What You Can Do	143
12.2 Configure a Filtering Rule	143
Chapter 13	
Spanning Tree Protocol	145
13.1 Spanning Tree Protocol Overview	145
13.1.1 What You Can Do	145
13.1.2 What You Need to Know	145
13.2 Spanning Tree Protocol Status	148
13.3 Spanning Tree Configuration	148
13.4 Rapid Spanning Tree Protocol Status	149
13.5 Configure Rapid Spanning Tree Protocol	150
13.6 Configure Multiple Spanning Tree Protocol	152
13.6.1 Multiple Spanning Tree Protocol Port Configuration	155
13.7 Multiple Spanning Tree Protocol Status	156
13.8 Configure Multiple Rapid Spanning Tree Protocol	159
13.9 Multiple Rapid Spanning Tree Protocol Status	160
13.10 Technical Reference	162
13.10.1 MSTP Network Example	162
13.10.2 MST Region	163
13.10.3 MST Instance	163
13.10.4 Common and Internal Spanning Tree (CIST)	164
Chapter 14	
Bandwidth Control	165
14.1 Bandwidth Control Overview	165
14.1.1 What You Can Do	165
14.2 Bandwidth Control Setup	165
Chapter 15	
Broadcast Storm Control	167
15.1 Broadcast Storm Control Overview	167
15.1.1 What You Can Do	167
15.2 Broadcast Storm Control Setup	167
Chapter 16	
Mirroring	169
16.1 Mirroring Overview	169
16.2 Port Mirroring Setup	169
Chapter 17	
Link Aggregation	171

17.1 Link Aggregation Overview	171
17.1.1 What You Can Do	171
17.1.2 What You Need to Know	171
17.2 Link Aggregation Status	172
17.3 Link Aggregation Setting	173
17.3.1 Link Aggregation Control Protocol	175
17.4 Technical Reference	177
17.4.1 Static Trunking Example	177
Chapter 18	
Port Authentication	179
18.1 Port Authentication Overview	179
18.1.1 What You Can Do	179
18.1.2 What You Need to Know	179
18.1.3 MAC Authentication	180
18.2 Port Authentication Configuration	180
18.3 Activate IEEE 802.1x Security	181
18.4 Activate MAC Authentication	182
18.5 Guest VLAN	184
18.6 Technical Reference	186
18.6.1 IEEE 802.1x	186
18.6.2 RADIUS	186
18.6.3 EAP (Extensible Authentication Protocol) Authentication	187
Chapter 19	
Port Security	189
19.1 About Port Security	189
19.2 Port Security Setup	189
Chapter 20	
Time Range	191
20.1 Time Range Overview	191
20.1.1 What You Can Do	191
20.2 Configuring Time Range	191
Chapter 21	
Classifier	193
21.1 Classifier Overview	193
21.1.1 What You Can Do	193
21.1.2 What You Need to Know	193
21.2 Classifier Status	194
21.3 Classifier Configuration	194
21.3.1 Viewing and Editing Classifier Configuration Summary	198

21.4 Classifier Global Setting Configuration	199
21.5 Classifier Example	200
Chapter 22	
Policy Rule	202
22.1 Policy Rules Overview	202
22.1.1 What You Can Do	202
22.1.2 DiffServ	202
22.1.3 DSCP and Per-Hop Behavior	202
22.2 Configuring Policy Rules	203
22.3 Policy Example	205
Chapter 23	
Queuing Method	206
23.1 Queuing Method Overview	206
23.1.1 What You Can Do	206
23.1.2 What You Need to Know	206
23.2 Configuring Queuing	207
Chapter 24	
Multicast	209
24.1 Multicast Overview	209
24.1.1 What You Can Do	209
24.1.2 What You Need to Know	209
24.2 Multicast Setup	213
24.3 IPv4 Multicast Status	213
24.3.1 IGMP Snooping	214
24.3.2 IGMP Snooping VLAN	217
24.3.3 IGMP Filtering Profile	218
24.4 IPv6 Multicast Status	220
24.4.1 MLD Snooping-proxy	220
24.4.2 MLD Snooping-proxy VLAN	221
24.4.3 MLD Snooping-proxy VLAN Port Role Setting	222
24.4.4 MLD Snooping-proxy Filtering	224
24.4.5 MLD Snooping-proxy Filtering Profile	225
24.5 General MVR Configuration	226
24.5.1 MVR Group Configuration	228
24.5.2 MVR Configuration Example	230
Chapter 25	
AAA	232
25.1 Authentication, Authorization and Accounting (AAA)	232
25.1.1 What You Can Do	232

25.1.2 What You Need to Know	232
25.2 AAA Screens	233
25.3 RADIUS Server Setup	233
25.4 TACACS+ Server Setup	235
25.5 AAA Setup	237
25.6 Technical Reference	239
25.6.1 Vendor Specific Attribute	239
25.6.2 Supported RADIUS Attributes	240
25.6.3 Attributes Used for Authentication	241
Chapter 26	
IP Source Guard	242
26.1 IP Source Guard Overview	242
26.1.1 What You Can Do	242
26.1.2 What You Need to Know	242
26.2 IPv4 Source Guard Setup	243
26.3 IPv4 Source Guard Static Binding	243
Chapter 27	
DHCP Snooping	246
27.1 DHCP Snooping Overview	246
27.1.1 What You Can Do	246
27.2 DHCP Snooping	246
27.3 DHCP Snooping Configure	249
27.3.1 DHCP Snooping Port Configure	250
27.3.2 DHCP Snooping VLAN Configure	251
27.3.3 DHCP Snooping VLAN Port Configure	252
27.4 Technical Reference	253
27.4.1 DHCP Snooping Overview	254
Chapter 28	
ARP Inspection	256
28.1 ARP Inspection Status	256
28.1.1 ARP Inspection VLAN Status	257
28.1.2 ARP Inspection Log Status	257
28.2 ARP Inspection Configure	258
28.2.1 ARP Inspection Port Configure	260
28.2.2 ARP Inspection VLAN Configure	261
28.3 Technical Reference	262
28.3.1 ARP Inspection Overview	262
Chapter 29	
Loop Guard	264

29.1 Loop Guard Overview	264
29.1.1 What You Can Do	264
29.1.2 What You Need to Know	264
29.2 Loop Guard Setup	266
Chapter 30	
Layer 2 Protocol Tunneling	267
30.1 Layer 2 Protocol Tunneling Overview	267
30.1.1 What You Can Do	267
30.1.2 What You Need to Know	267
30.2 Configuring Layer 2 Protocol Tunneling	268
Chapter 31	
PPPoE	271
31.1 PPPoE Intermediate Agent Overview	271
31.1.1 What You Can Do	271
31.1.2 What You Need to Know	271
31.2 PPPoE	273
31.3 PPPoE Intermediate Agent	274
31.3.1 PPPoE IA Per-Port	275
31.3.2 PPPoE IA Per-Port Per-VLAN	276
31.3.3 PPPoE IA for VLAN	277
Chapter 32	
Error Disable	279
32.1 Error Disable Overview	279
32.1.1 CPU Protection Overview	279
32.1.2 Error-Disable Recovery Overview	279
32.1.3 What You Can Do	279
32.2 Error Disable Settings	280
32.3 Error-Disable Status	280
32.4 CPU Protection Configuration	282
32.5 Error-Disable Detect Configuration	283
32.6 Error-Disable Recovery Configuration	284
Chapter 33	
VLAN Isolation	286
33.1 VLAN Isolation Overview	286
33.2 Configuring VLAN Isolation	286
Chapter 34	
Green Ethernet	288
34.1 Green Ethernet Overview	288

34.2 Configuring Green Ethernet	288
Chapter 35	
Link Layer Discovery Protocol (LLDP)	290
35.1 LLDP Overview	290
35.2 LLDP-MED Overview	291
35.3 LLDP Settings	292
35.4 LLDP Local Status	293
35.4.1 LLDP Local Port Status Detail	294
35.5 LLDP Remote Status	297
35.5.1 LLDP Remote Port Status Detail	298
35.6 LLDP Configuration	304
35.6.1 LLDP Configuration Basic TLV Setting	305
35.6.2 LLDP Configuration Org-specific TLV Setting	306
35.7 LLDP-MED Configuration	307
35.8 LLDP-MED Network Policy	308
35.9 LLDP-MED Location	309
Chapter 36	
OAM	313
36.1 OAM Overview	313
36.1.1 What You Can Do	313
36.2 OAM Status	313
36.2.1 OAM Details	314
36.3 OAM Configuration	317
36.4 OAM Remote Loopback	319
Chapter 37	
Static Route.....	320
37.1 Static Routing Overview	320
37.1.1 What You Can Do	320
37.2 Static Routing	320
37.3 IPv4 Static Route	321
Chapter 38	
Differentiated Services	324
38.1 DiffServ Overview	324
38.1.1 What You Can Do	324
38.1.2 What You Need to Know	324
38.2 Activating DiffServ	325
38.3 DSCP-to-IEEE 802.1p Priority Settings	326
38.3.1 Configuring DSCP Settings	326

Chapter 39	
DHCP	328
39.1 DHCP Overview	328
39.1.1 What You Can Do	328
39.1.2 What You Need to Know	328
39.2 DHCP Configuration	329
39.3 DHCPv4 Status	329
39.4 DHCPv4 Relay	329
39.4.1 DHCPv4 Relay Agent Information	330
39.4.2 DHCPv4 Option 82 Profile	331
39.4.3 Configuring DHCPv4 Global Relay	332
39.4.4 Configure DHCPv4 Global Relay Port	333
39.4.5 Global DHCP Relay Configuration Example	334
39.4.6 DHCPv4 VLAN Setting	335
39.4.7 Configure DHCPv4 VLAN Port	336
39.4.8 Example: DHCP Relay for Two VLANs	337
39.5 DHCPv6 Relay	338
Chapter 40	
ARP Setup	340
40.1 ARP Overview	340
40.1.1 What You Can Do	340
40.1.2 What You Need to Know	340
40.2 ARP Setup	342
40.2.1 ARP Learning	342
Chapter 41	
Maintenance	344
41.1 Overview	344
41.1.1 What You Can Do	344
41.2 Maintenance Settings	344
41.2.1 Erase Running-Configuration	345
41.2.2 Save Configuration	346
41.2.3 Reboot System	346
41.2.4 Factory Default	347
41.2.5 Custom Default	347
41.3 Firmware Upgrade	348
41.4 Restore Configuration	349
41.5 Backup Configuration	350
41.6 Tech-Support	350
41.6.1 Tech-Support Download	352
41.7 Certificates	352
41.7.1 HTTPS Certificates	353

41.8 Technical Reference	354
41.8.1 FTP Command Line	354
41.8.2 Filename Conventions	354
41.8.3 FTP Command Line Procedure	355
41.8.4 GUI-based FTP Clients	356
41.8.5 FTP Restrictions	356
Chapter 42	
Access Control.....	357
42.1 Access Control Overview	357
42.1.1 What You Can Do	357
42.2 Access Control Main Settings	357
42.3 Configure SNMP	358
42.3.1 Configure SNMP Trap Group	359
42.3.2 Enable or Disable Sending of SNMP Traps on a Port	360
42.3.3 Configure SNMP User	361
42.4 Set Up Login Accounts	363
42.5 Service Access Control	364
42.6 Remote Management	365
42.7 Technical Reference	366
42.7.1 About SNMP	367
42.7.2 SSH Overview	372
42.7.3 Introduction to HTTPS	374
42.7.4 Google Chrome Warning Messages	378
Chapter 43	
Diagnostic.....	380
43.1 Overview	380
43.2 Diagnostic	380
Chapter 44	
System Log.....	383
44.1 Overview	383
44.2 System Log	383
Chapter 45	
Syslog Setup	384
45.1 Syslog Overview	384
45.1.1 What You Can Do	384
45.2 Syslog Setup	384
Chapter 46	
Cluster Management.....	387

46.1 Cluster Management Overview	387
46.1.1 What You Can Do	388
46.2 Cluster Management Status	388
46.3 Clustering Management Configuration	389
46.4 Technical Reference	391
46.4.1 Cluster Member Switch Management	391
Chapter 47	
MAC Table.....	393
47.1 MAC Table Overview	393
47.1.1 What You Can Do	393
47.1.2 What You Need to Know	393
47.2 Viewing the MAC Table	394
Chapter 48	
ARP Table.....	396
48.1 Overview	396
48.1.1 What You Can Do	396
48.1.2 What You Need to Know	396
48.2 Viewing the ARP Table	396
Chapter 49	
Path MTU Table	398
49.1 Path MTU Overview	398
49.2 Viewing the Path MTU Table	398
Chapter 50	
Configure Clone.....	399
50.1 Overview	399
50.2 Configure Clone	399
Chapter 51	
IPv6 Neighbor Table.....	402
51.1 IPv6 Neighbor Table Overview	402
51.2 Viewing the IPv6 Neighbor Table	402
Chapter 52	
Port Status	404
52.1 Overview	404
52.2 Port Status	404
52.2.1 Port Details	405
52.2.2 DDMI	408
52.2.3 DDMI Details	409

52.2.4 Port Utilization 410

Part III: Troubleshooting and Appendices 412

**Chapter 53
Troubleshooting 413**

53.1 Power, Hardware Connections, and LEDs 413

53.2 Switch Access and Login 414

53.3 Switch Configuration 416

Appendix A Customer Support 417

Appendix B Common Services 423

Appendix C IPv6 426

Appendix D Legal Information 434

Index 439

PART I

User's Guide

CHAPTER 1

Getting to Know Your Switch

1.1 Introduction

This chapter introduces the main features and applications of the Switch.

The GS1920v2 Series consists of the following models:

- GS1920-8HPv2
- GS1920-24v2
- GS1920-24HPv2
- GS1920-48v2
- GS1920-48HPv2

References to PoE models in this User's Guide only apply to GS1920-8HPv2, GS1920-24HPv2 and GS1920-48HPv2.

The following table describes the hardware features of the Switch by model.

Table 1 GS1920v2 Series Comparison Table

FEATURE	GS1920-8HPV2	GS1920-24V2	GS1920-24HPV2	GS1920-48V2	GS1920-48HPV2
10/100/1000 Mbps Ethernet Ports	-	24	-	44	-
10/100/1000 Mbps PoE Ports	8	-	24	-	48
GbE Dual Personality Interface	2	4	4	4	4
1 Gbps SFP Interface	-	-	-	2	2
FAN	-	-	2	1	2
Wall-mount	V	-	-	-	-
Rack-mount	-	V	V	V	V
Desk-mount	V	-	-	-	-

NebulaFlex for 'hybrid mode' means you can set the Switch to operate in only one of either direct standalone or cloud mode (not both at the same time). The Nebula Control Center (NCC) is an alternative cloud-based network management system that allows you to remotely manage and monitor the Switch in cloud mode.

Use the Web Configurator to configure and manage the Switch directly in standalone mode or use Nebula Control Center (NCC) to configure and manage the Switch in cloud mode. You may also access a minimized version of the Web Configurator in cloud mode.

Nebula Cloud Management

To have Nebula manage the Switch, you must first register it at the Nebula web portal at <https://nebula.zyxel.com>, and ensure that **Nebula Control Center Discovery** is enabled in **Basic Setting > Cloud Management > Nebula Control Center Discovery** in the Switch Web Configurator.

Note: See the Switch's datasheet for the feature differences between standalone and Nebula cloud management modes. You can find the Switch's datasheet at the Zyxel website.

See the NCC (Nebula Control Center) User's Guide for how to configure the Switch using Nebula.

1.1.1 Mode Changing

This section describes how to change the Switch's management mode.

Note: If you change the Switch's management mode from standalone mode to Nebula-managed mode, the configuration settings of the Switch will be overwritten with what you have configured in Nebula.

Note: If you change the Switch's management mode from Nebula-managed mode to standalone mode, the Switch will reset to its factory-default settings.

From Standalone to Nebula Cloud Management

To manage your Switch via Nebula, connect the Switch to the Internet, and register it to a site and organization at the Nebula web portal (<https://nebula.zyxel.com>).

See the following steps or the Switch Quick Start Guide for how to do device registration.

Go to the NCC to Register the Switch

- 1 Go to the Nebula web portal in one of three ways.
 - Type <https://nebula.zyxel.com> in a supported web browser. See the Nebula User's Guide for more information about supported browsers.
 - Click **Visit Nebula** in the Switch's login page.
 - Click the **Nebula** icon in the upper right corner of the Switch's Web Configurator.
- 2 Click **Login** in the Nebula web portal. Enter your myZyxel account information. You will be redirected to another screen where you can sign up for a myZyxel account if you do not have one.
- 3 Create an organization and a site or select an existing site using the Nebula setup wizard.
- 4 Register the Switch by entering its MAC address and serial number and assign it to the site. The serial number and MAC address can be found in the **Status** screen or the device back label on the Switch.

Use the Zyxel Nebula Mobile App to Register the Switch

- 1 Download and open the Zyxel Nebula Mobile app in your mobile device. Click **Sign Up** to create a myZyxel account or enter your existing account information to log in.
- 2 Create an organization and site, or select an existing site using the Zyxel Nebula Mobile app.

- 3 Select a site and scan the Switch's QR code to add it to the site. You can find the QR code:
 - On a label on the Switch or
 - On its box or
 - In the Web Configurator at **Basic > Cloud Management > Nebula Switch Registration**.

See [Section 3.3 on page 42](#) for more information about the **CLOUD** LED or [Section 7.2 on page 75](#) for more information about the **Hybrid Mode** field in the **Status** screen to see if the Switch goes into Nebula cloud management mode successfully.

Note: The Switch goes into Nebula-managed mode automatically after it can access the Nebula web portal and is successfully registered there. Its login password and settings are then overwritten with what you have configured in the Nebula web portal.

From Nebula-managed to Standalone

To return to direct management standalone mode, just remove (unregister) the Switch from the organization or site in the Nebula web portal. The Switch will reboot and restore the factory default settings.

1.1.2 ZON Utility

With its built-in Web Configurator, including the Neighbor Management feature ([Section 7.2.1 on page 77](#)), viewing, managing and configuring the Switch and its neighboring devices is simplified.

In addition, Zyxel offers a proprietary software program called Zyxel One Network (ZON) Utility, it is a utility tool that assists you to set up and maintain network devices in a more simple and efficient way. You can download the ZON Utility at www.zyxel.com and install it on a PC (Windows operation system). For more information on ZON Utility see [Section 4.3 on page 49](#).

The following table shows which firmware version supports ZON and Neighbor Management (Smart Connect) for each Switch. The firmware on each Switch is identified by the firmware trunk version, followed by a unique model code and release number in brackets. For example, 4.50(ABMK.0) is a firmware version for GS1920-48HPv2 where 4.50 is the firmware trunk version, ABMK identifies the GS1920-48HPv2 and .0 is the first release of trunk version 4.50.

Table 2 Models and Firmware Version

SWITCH MODEL	FIRMWARE VERSION
GS1920-8HPv2	4.50(ABKZ.0) and later
GS1920-24v2	4.50(ABMH.0) and later
GS1920-24HPv2	4.50(ABMI.0) and later
GS1920-48v2	4.50(ABMJ.0) and later
GS1920-48HPv2	4.50(ABMK.0) and later

1.1.3 PoE

The Switch is a Power Sourcing Equipment (PSE) because it provides a source of power via its Ethernet ports. Each device that receives power through an Ethernet port is a Powered Device (PD).

The GS1920-8HPv2, GS1920-24HPv2, and GS1920-48HPv2 come with a Power-over-Ethernet (PoE) feature. The GS1920-8HPv2, GS1920-24HPv2, and GS1920-48HPv2 support the IEEE 802.3at High Power

over Ethernet (PoE) standard and IEEE 802.3af PoE standard.

Key feature differences between Switch models are as follows. Other features are common to all models.

The following table describes the PoE features of the Switch by model.

Table 3 Models and PoE Features

SWITCH MODEL	POE FEATURES
GS1920-8HPv2	IEEE 802.3af PoE
GS1920-24HPv2	IEEE 802.3at High Power over Ethernet (PoE)
GS1920-48HPv2	Power management mode – Classification
	Power management mode – Consumption
	Scheduled PoE (PoE Time Range)

1.2 Example Applications

This section shows a few examples of using the Switch in various network environments. Note that the Switch in the figure is just an example Switch and not your actual Switch.

1.2.1 PoE Example Application

The following example figure shows a Switch supplying PoE (Power over Ethernet) to Powered Devices (PDs) such as an IP camera, a wireless router, an IP telephone and a general outdoor router that are not within reach of a power outlet.

Figure 1 PoE Example Application

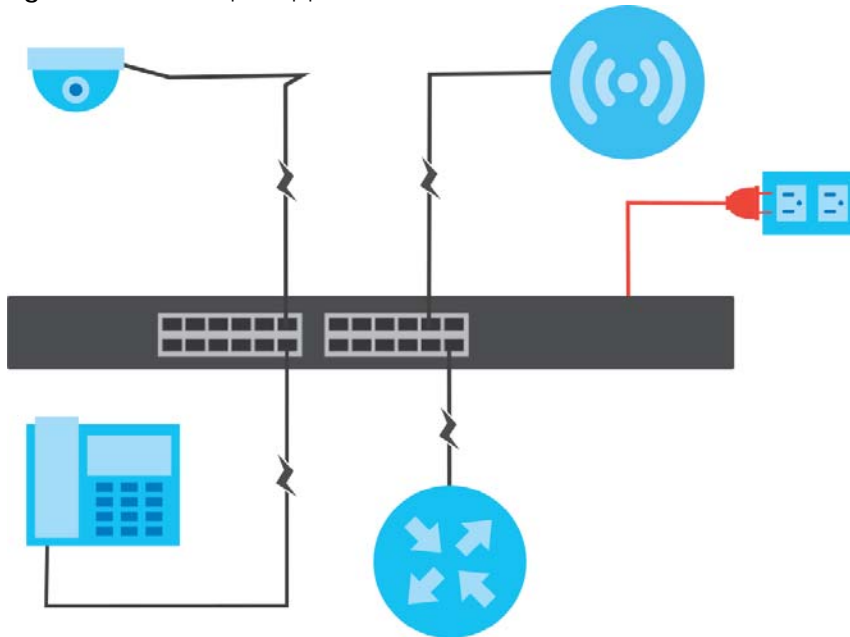

1.2.2 Backbone Example Application

The Switch is an ideal solution for small networks where rapid growth can be expected in the near future. The Switch can be used standalone for a group of heavy traffic users. You can connect computers and servers directly to the Switch's port or connect other switches to the Switch.

In this example, all computers can share high-speed applications on the server. To expand the network, simply add more networking devices such as switches, routers, computers, print servers, and so on.

Figure 2 Backbone Application

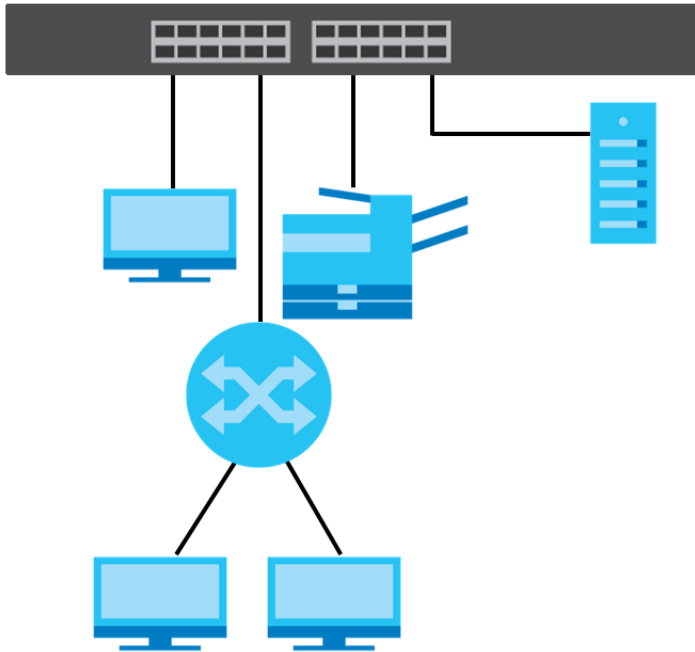

1.2.3 Bridging or Fiber Uplink Example Application

In this example, the Switch connects different company departments (**RD** and **Sales**) to the corporate backbone. It can alleviate bandwidth contention and eliminate server and network bottlenecks. All users that need high bandwidth can connect to high-speed department servers via the Switch. You can provide a super-fast uplink connection by using a Gigabit Ethernet or SFP port on the Switch.

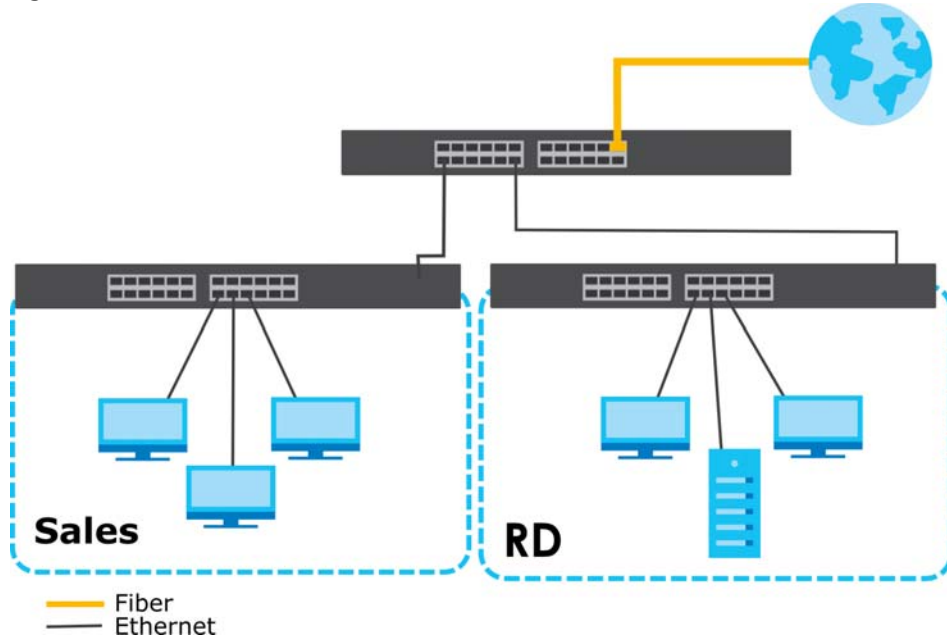
Figure 3 Bridging or Fiber Uplink Example Application

1.2.4 High Performance Switching Example

The Switch is ideal for connecting two networks that need high bandwidth. In the following example, use link aggregation (trunking) to connect these two networks.

Switching to higher-speed LANs such as ATM (Asynchronous Transmission Mode) is not feasible for most people due to the expense of replacing all existing Ethernet cables and adapter cards, restructuring your network and complex maintenance. The Switch can provide the same bandwidth as ATM at much lower cost while still being able to use existing adapters and switches. Moreover, the current LAN structure can be retained as all ports can freely communicate with each other.

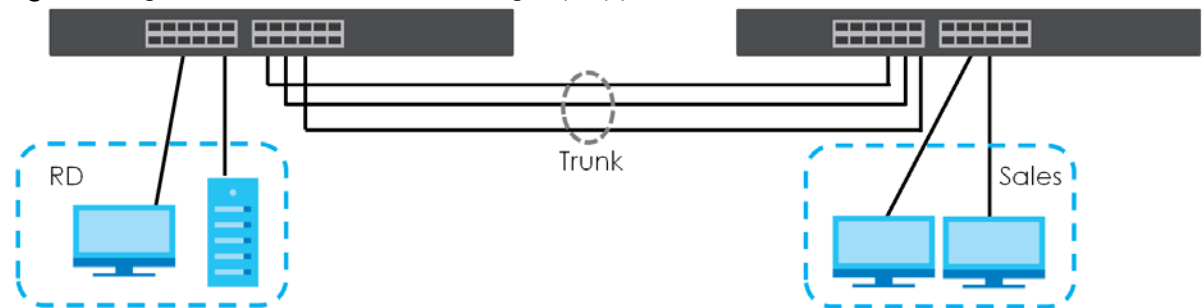
Figure 4 High Performance Switched Workgroup Application

1.2.5 IEEE 802.1Q VLAN Application Examples

A VLAN (Virtual Local Area Network) allows a physical network to be partitioned into multiple logical networks. Stations on a logical network belong to one or more groups. With VLAN, a station cannot directly talk to or hear from stations that are not in the same groups unless such traffic first goes through a router.

1.2.5.1 Tag-based VLAN Example

Ports in the same VLAN group share the same frame broadcast domain thus increase network performance through reduced broadcast traffic. VLAN groups can be modified at any time by adding, moving or changing ports without any re-cabling.

Shared resources such as a server can be used by all ports in the same VLAN as the server. In the following figure only ports that need access to the server need to be part of VLAN 1. Ports can belong to other VLAN groups too.

Figure 5 Shared Server Using VLAN Example

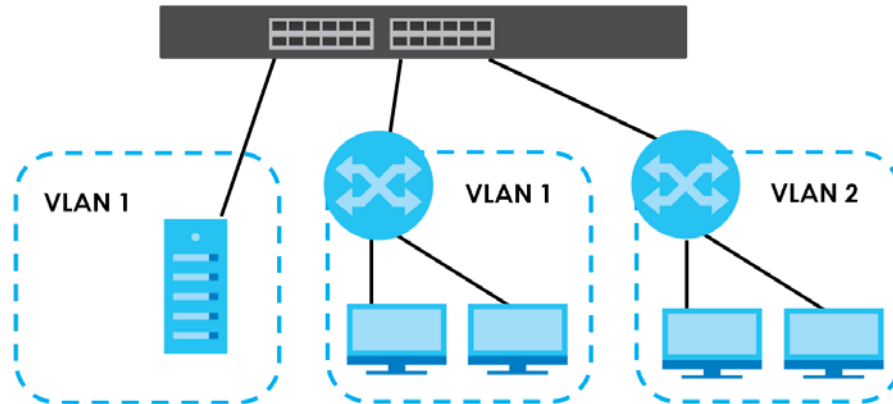

1.3 Ways to Manage the Switch

Use any of the following methods to manage the Switch.

- NCC (Zyxel Nebula Control Center). With the NCC, you can remotely manage and monitor the Switch through a cloud-based network management system. See [Section 8.11 on page 112](#) or the NCC User's Guide for detailed information about how to access the NCC and manage your Switch via the NCC. See the NCC User's Guide for how to configure Nebula managed devices.
- Web Configurator. This is recommended for everyday management of the Switch using a (supported) web browser. See [Chapter 4 on page 46](#).
- FTP. Use File Transfer Protocol for firmware upgrades and configuration backup or restore. See [Section 41.8.1 on page 354](#).
- SNMP. The Switch can be monitored and/or managed by an SNMP manager. See [Section 42.7.1 on page 367](#).
- Cluster Management. Cluster Management allows you to manage multiple switches through one switch, called the cluster manager. See [Chapter 46 on page 387](#).
- ZON Utility. ZON Utility is a program designed to help you deploy and perform initial setup on a network more efficiently. See [Section 4.3 on page 49](#).

1.4 Good Habits for Managing the Switch

Do the following things regularly to make the Switch more secure and to manage the Switch more effectively.

- Change the password. Use a password that is not easy to guess and that consists of different types of characters, such as numbers and letters.
- Write down the password and put it in a safe place.
- Back up the configuration (and make sure you know how to restore it). Restoring an earlier working configuration may be useful if the device becomes unstable or even crashes. If you forget your password, you will have to reset the Switch to its factory default settings. If you backed up an earlier configuration file, you would not have to totally re-configure the Switch. You could simply restore your last configuration.

CHAPTER 2

Hardware Installation and Connection

2.1 Installation Scenarios

This chapter shows you how to install and connect the Switch.

The Switch can be:

- Placed on a desktop.
- Desk-mounted under a table.
- Wall-mounted on a wall.
- Rack-mounted on a standard EIA rack.

2.2 Safety Precautions

Please observe the following before using the Switch:

- It is recommended to ask an authorized technician to attach the Switch on a desk or to the rack or wall. Use the proper screws to prevent damage to the Switch. See the **Installation Requirements** sections in this chapter to know the types of screws and screw drivers for each mounting method.
- Make sure there is at least 2 cm of clearance on the top and bottom of the Switch, and at least 5 cm of clearance on all four sides of the Switch. This allows air circulation for cooling.
- Do NOT block the ventilation holes nor store cables or power cords on the Switch. Allow clearance for the ventilation holes to prevent your Switch from overheating. This is especially crucial when your Switch does not have fans. Overheating could affect the performance of your Switch, or even damage it.
- The surface of the Switch could be hot when it is functioning. Do NOT put your hands on it. You may get burned. This could happen especially when you are using a fanless Switch.
- The Switches with fans are not suitable for use in locations where children are likely to be present.

To start using the Switch, simply connect the power cables and turn it on.

2.3 Desktop Installation Procedure

- 1 Make sure the Switch is clean and dry.

- 2 Remove the adhesive backing from the rubber feet.
- 3 Attach the rubber feet to each corner on the bottom of the Switch. These rubber feet help protect the Switch from shock or vibration and ensure space between devices when stacking.

Figure 6 Attaching Rubber Feet

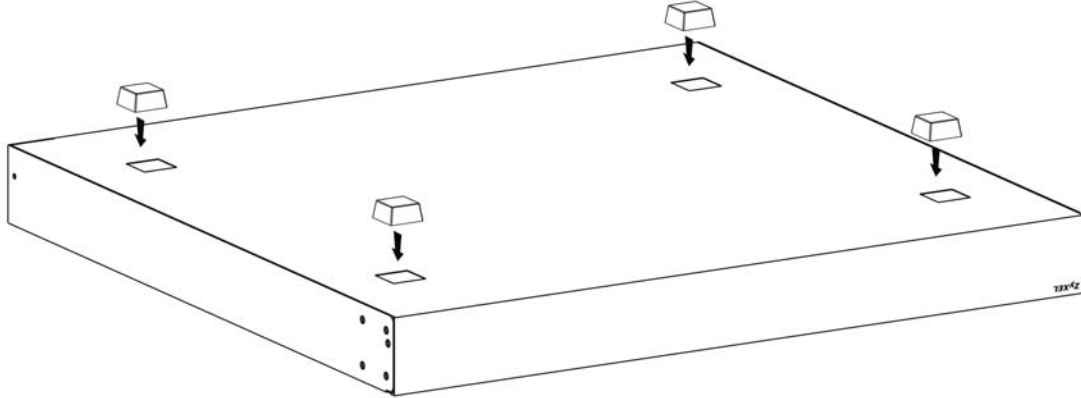

- 4 Set the Switch on a smooth, level surface strong enough to support the weight of the Switch and the connected cables. Make sure there is a power outlet nearby.

Cautions:

- Avoid stacking fanless Switches to prevent overheating.
- Ensure enough clearance around the Switch to allow air circulation for cooling.
- Do NOT remove the rubber feet as it provides space for air circulation.

2.4 Desk Mounting (GS1920-8HPv2 Only)

The GS1920-8HPv2 can be mounted under a table. Follow the steps below to mount your Switch under a table.

2.4.1 Installation Requirements

- Two mounting brackets
- Eight M3 flat head screws and a #2 Philips screwdriver
- Four M4 flat head screws and a #2 Philips screwdriver
- Four washers (inside diameter: 3.5 mm; outside diameter: 11.5 mm)

2.4.2 Precautions

- Make sure to place the Switch horizontally under a smooth level surface.
- Make sure the table is sturdy enough for desk mounting.
- Make sure there is enough table thickness to drill screws.
- Make sure there is sufficient space for port connections.

2.4.3 Attaching the Mounting Brackets to the Switch

- 1 Position a mounting bracket on one side of the Switch, lining up the four screw holes on the bracket with the screw holes on the side of the Switch.

Figure 7 Attaching the Mounting Brackets

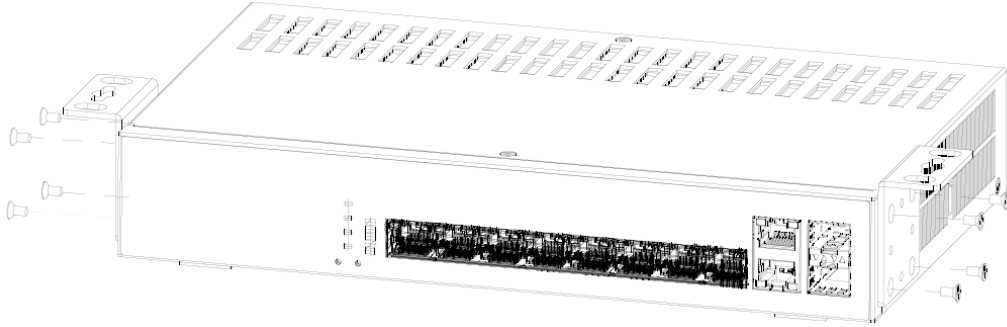

- 2 Using a #2 Philips screwdriver, install the M3 flat head screws through the mounting bracket holes into the Switch.
- 3 Repeat steps 1 and 2 to install the second mounting bracket on the other side of the Switch.
- 4 You may now mount the Switch under a table. Proceed to the next section.

2.4.4 Mounting the Switch under a Table

- 1 Determine where you want to mount the Switch under a table. See [Section 2.4 on page 30](#) to choose a suitable location.
- 2 Position the Switch in place and mark the places for drilling with the attached brackets.
- 3 Drill holes at the marked places under the table.
- 4 Line up the two screw holes on the bracket with the screw holes under the table.

Figure 8 Mounting the Switch under a Table

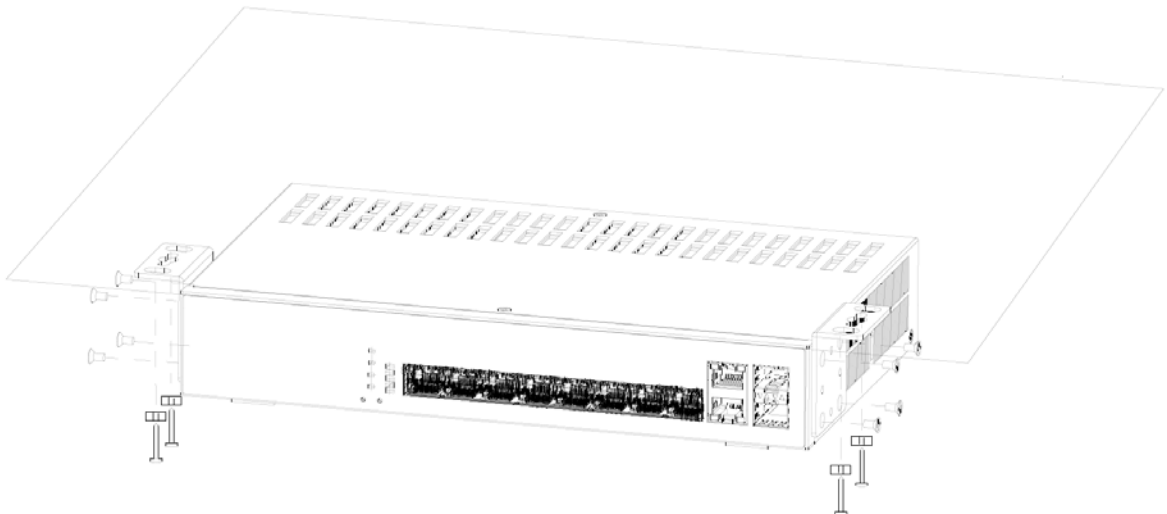

- 5 Place the washers on the screw holes of the bracket.
- 6 Using a #2 Philips screwdriver, install the M4 flat head screws through the washers and mounting bracket holes into the table. The washers should be in between the M4 flat head screws and the brackets.
- 7 Repeat steps 1 and 6 to attach the second mounting bracket under the table.

2.5 Wall Mounting (GS1920-8HPv2 Only)

The Switch can be mounted on a wall. You may need screw anchors if mounting on a concrete or brick wall.

2.5.1 Installation Requirements

- Distance above the floor: At least 1.8 m (5.9 feet)
- Distance between holes: 78 mm (3.071 inches)
- Two M4 screws and a #2 Philips screwdriver
- Two screw anchors (optional)

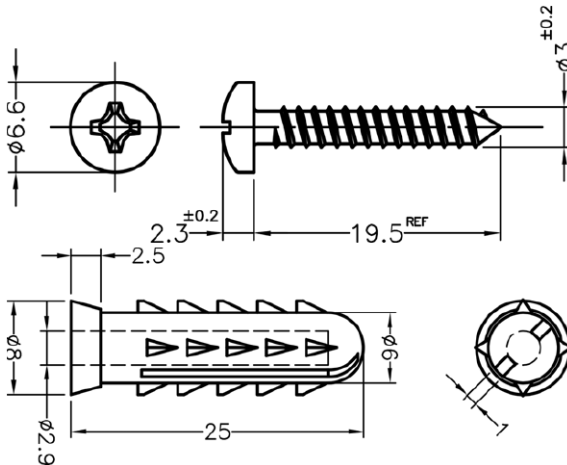

- 1 Select a position free of obstructions on a wall strong enough to hold the weight of the Switch.
- 2 Mark two holes on the wall at the appropriate distance apart for the screws.

WARNING! Be careful to avoid damaging pipes or cables located inside the wall when drilling holes for the screws.

- 3 If using screw anchors, drill two holes for the screw anchors into the wall. Push the anchors into the full depth of the holes, then insert the screws into the anchors. Do NOT insert the screws all the way in – leave a small gap of about 0.5 cm.

If not using screw anchors, use a screwdriver to insert the screws into the wall. Do NOT insert the screws all the way in – leave a gap of about 0.5 cm.

- 4 Make sure the screws are fastened well enough to hold the weight of the Switch with the connection cables.

- 5 Align the holes on the back of the Switch with the screws on the wall. Hang the Switch on the screws.

Note: Make sure there is enough clearance between the wall and the Switch to allow ventilation.

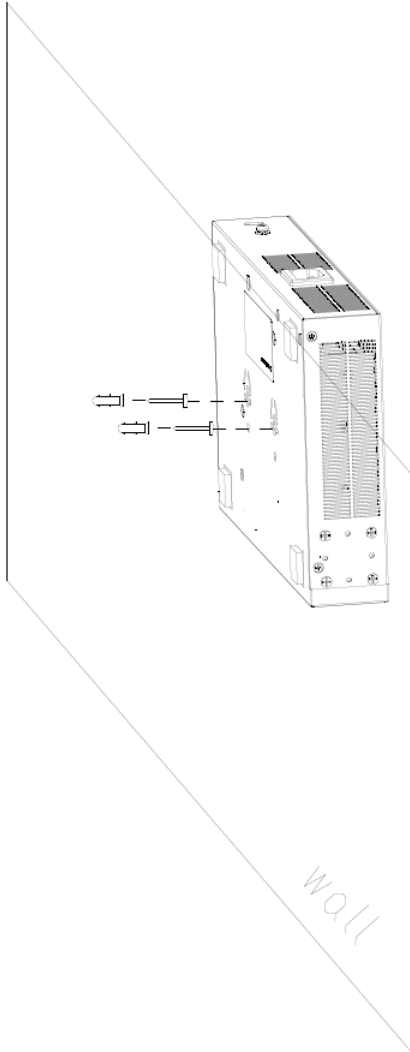

WARNING! The Switch should be wall-mounted horizontally, and make sure the front panel is facing down. The Switch's side panels with ventilation slots should not be facing up or down as this position is less safe.

2.6 Mounting the Switch on a Rack

The Switch can be mounted on an EIA standard size, 19-inch rack or in a wiring closet with other equipment. Follow the steps below to mount your Switch on a standard EIA rack using a rack-mounting kit.

Note: Make sure there is enough clearance between each equipment on the rack for air circulation.

2.6.1 Installation Requirements

- Two mounting brackets.
- Eight M3 flat head screws and a #2 Philips screwdriver.
- Four M5 flat head screws and a #2 Philips screwdriver.

2.6.2 Precautions

- Make sure the rack will safely support the combined weight of all the equipment it contains. The maximum weight a bracket can hold is 21.5 kg.
- Make sure the position of the Switch does not make the rack unstable or top-heavy. Take all necessary precautions to anchor the rack securely before installing the unit.

2.6.3 Attaching the Mounting Brackets to the Switch

- 1 Position a mounting bracket on one side of the Switch, lining up the four screw holes on the bracket with the screw holes on the side of the Switch.

Figure 9 Attaching the Mounting Brackets

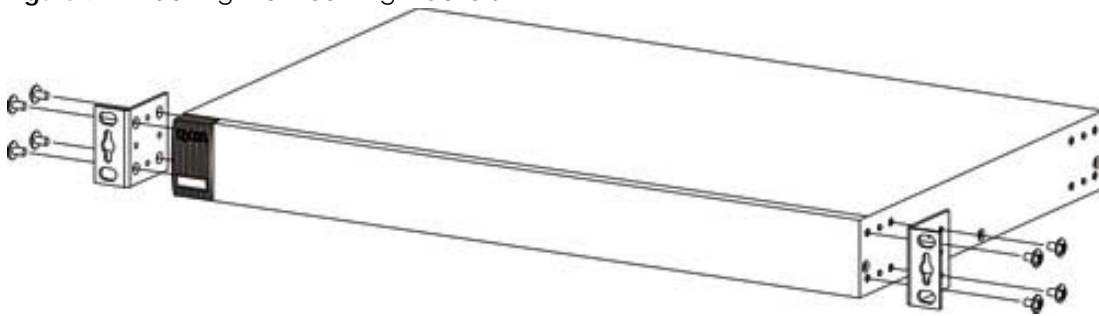

- 2 Using a #2 Philips screwdriver, install the M3 flat head screws through the mounting bracket holes into the Switch.
- 3 Repeat steps 1 and 2 to install the second mounting bracket on the other side of the Switch.
- 4 You may now mount the Switch on a rack. Proceed to the next section.

2.6.4 Mounting the Switch on a Rack

- 1 Position a mounting bracket (that is already attached to the Switch) on one side of the rack, lining up the two screw holes on the bracket with the screw holes on the side of the rack.

Figure 10 Mounting the Switch on a Rack

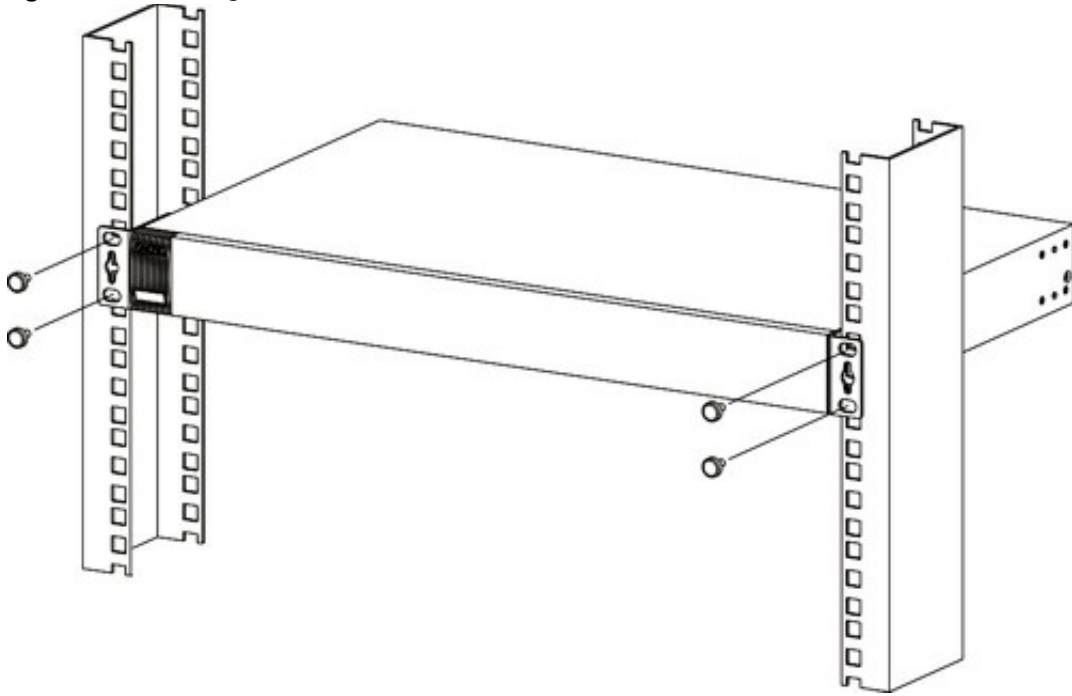

- 2 Using a #2 Philips screwdriver, install the M5 flat head screws through the mounting bracket holes into the rack.

Note: Make sure you tighten all the four screws to prevent the Switch from getting slanted.

- 3 Repeat steps 1 and 2 to attach the second mounting bracket on the other side of the rack.

CHAPTER 3

Hardware Panels

This chapter describes the front panel and rear panel of the Switch and shows you how to make the hardware connections.

3.1 Front Panel Connections

Note that the front panels of the Switch do not state the v2 model names.

Figure 11 Front Panel: GS1920-8HPv2



Figure 12 Front Panel: GS1920-24v2



Figure 13 Front Panel: GS1920-24HPv2



Figure 14 Front Panel: GS1920-48v2



Figure 15 Front Panel: GS1920-48HPv2



3.1.1 Ethernet Ports

The Switch has 1000Base-T auto-negotiating, auto-crossover Ethernet ports. In 10/100/1000 Mbps Gigabit, the speed can be 10 Mbps, 100 Mbps or 1000 Mbps and the duplex mode can be half duplex or full duplex.

An auto-negotiating port can detect and adjust to the optimum Ethernet speed (10/100/1000 Mbps) and duplex mode (full duplex or half duplex) of the connected device.

An auto-negotiating port can detect and adjust to the optimum Ethernet speed (10/100/1000 Mbps) and full duplex mode of the connected device.

An auto-crossover (auto-MDI/MDI-X) port automatically works with a straight-through or crossover Ethernet cable.

Four 1000Base-T Ethernet ports are paired with an SFP slot to create a dual personality interface. The Switch uses up to one connection for each SFP and 1000Base-T Ethernet pair. The SFP slots have priority over the Gigabit ports. This means that if an SFP slot and the corresponding GbE port are connected at the same time, the GbE port will be disabled.

Note: The dual personality ports change to fiber mode directly when inserting the fiber module.

When auto-negotiation is turned on, an Ethernet port negotiates with the peer automatically to determine the connection speed and duplex mode. If the peer Ethernet port does not support auto-negotiation or turns off this feature, the Switch determines the connection speed by detecting the signal on the cable and using half duplex mode. When the Switch's auto-negotiation is turned off, an Ethernet port uses the pre-configured speed and duplex mode when making a connection, thus requiring you to make sure that the settings of the peer Ethernet port are the same in order to connect.

3.1.1.1 Default Ethernet Negotiation Settings

The factory default negotiation settings for the ports on the Switch are:

- Speed: Auto
- Duplex: Auto
- Flow control: Off
- Link Aggregation: Disabled

3.1.1.2 Auto-crossover

All ports support auto-crossover, that is auto-MDIX ports (Media Dependent Interface Crossover), so you may use either a straight-through Ethernet cable or crossover Ethernet cable for all Gigabit port connections. Auto-crossover ports automatically sense whether they need to function as crossover or straight ports, so crossover cables can connect both computers and switches or hubs.

3.1.2 PoE (GS1920-8HPv2 & GS1920-24HPv2 & GS1920-48HPv2)

The Switch supports both the IEEE 802.3af Power over Ethernet (PoE) and IEEE 802.3at Power over Ethernet (PoE) plus standards. The Switch is a Power Sourcing Equipment (PSE) because it provides a source of power via its Ethernet ports. Each device that receives power through an Ethernet port is a Powered Device (PD).

3.1.3 SFP Slots

These are slots for SFP (Small Form-Factor Pluggable) transceivers. A transceiver is a single unit that houses a transmitter and a receiver. The Switch does not come with transceivers. You must use transceivers that comply with the Small Form-factor Pluggable (SFP) Transceiver MultiSource Agreement (MSA). See the SFF committee's INF-8074i specification Rev 1.0 for details.

You can change transceivers while the Switch is operating. You can use different transceivers to connect to Ethernet switches with different types of fiber or even copper cable connectors.

- Type: SFP connection interface
- Connection speed: 100/1000 Mbps

WARNING! To avoid possible eye injury, do not look into an operating fiber module's connectors.

HANDLING! All transceivers are static sensitive. To prevent damage from electrostatic discharge (ESD), it is recommended you attach an ESD preventive wrist strap to your wrist and to a bare metal surface when you install or remove a transceiver.

STORAGE! All modules are dust sensitive. When not in use, always keep the dust plug on. Avoid getting dust and other contaminant into the optical bores, as the optics do not work correctly when obstructed with dust.

3.1.3.1 Transceiver Installation

Use the following steps to install a transceiver.

- 1 Attach an ESD preventive wrist strap to your wrist and to a bare metal surface.
- 2 Align the transceiver in front of the slot opening.
- 3 Make sure the latch is in the lock position (latch styles vary), then insert the transceiver into the slot with the exposed section of PCB board facing down.
- 4 Press the transceiver firmly until it clicks into place.
- 5 The Switch automatically detects the installed transceiver. Check the LEDs to verify that it is functioning properly.
- 6 Remove the dust plugs from the transceiver and cables (dust plug styles vary).
- 7 Identify the signal transmission direction of the fiber cables and the transceiver. Insert the fiber cable into the transceiver.

Figure 16 Latch in the Lock Position

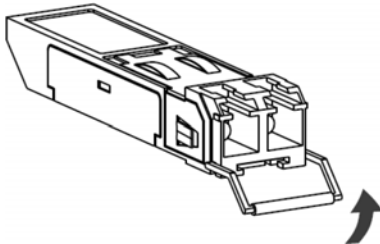
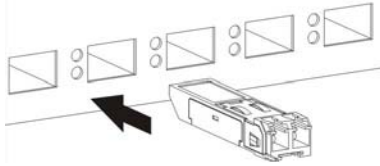
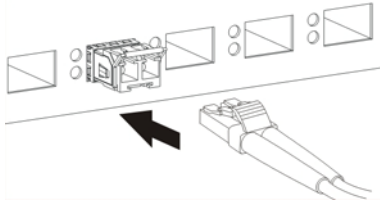

Figure 17 Transceiver Installation Example**Figure 18** Connecting the Fiber Cables

3.1.3.2 Transceiver Removal

Use the following steps to remove an SFP transceiver.

- 1 Attach an ESD preventive wrist strap to your wrist and to a bare metal surface on the chassis.
- 2 Remove the fiber cables from the transceiver.
- 3 Pull out the latch and down to unlock the transceiver (latch styles vary).

Note: Make sure the transceiver's latch is pushed all the way down, so the transceiver can be pulled out successfully.

- 4 Pull the latch, or use your thumb and index finger to grasp the tabs on both sides of the transceiver, and carefully slide it out of the slot.

Note: Do NOT pull the transceiver out by force. You could damage it. If the transceiver will not slide out, grasp the tabs on both sides of the transceiver with a slight up or down motion and carefully slide it out of the slot. If unsuccessful, contact Zyxel Support to prevent damage to your Switch and transceiver.

- 5 Insert the dust plug into the ports on the transceiver and the cables.

Figure 19 Removing the Fiber Cables**Figure 20** Opening the Transceiver's Latch Example

Figure 21 Transceiver Removal Example

3.2 Rear Panel

The following figures show the rear panels of the Switch. The rear panels contain:

Figure 22 Rear Panel: GS1920-8HPv2**Figure 23** Rear Panel: GS1920-24v2**Figure 24** Rear Panel: GS1920-24HPv2**Figure 25** Rear Panel: GS1920-48v2**Figure 26** Rear Panel: GS1920-48HPv2

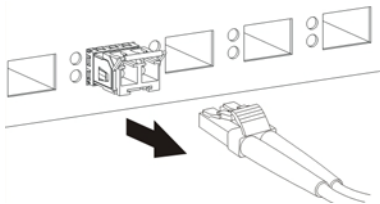
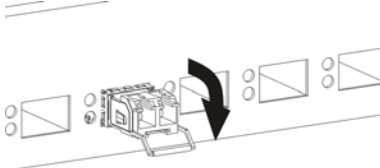
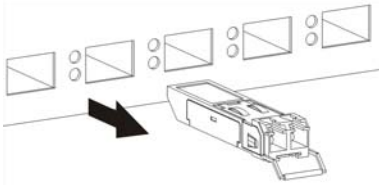
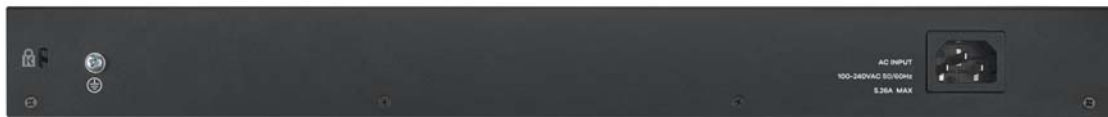
3.2.1 Grounding

Grounding is a safety measure to direct excess electric charge to the ground. It prevents damage to the Switch, and protects you from electrocution. Use the grounding screw on the rear panel and the ground wire of the AC power supply to ground the Switch.

The grounding terminal and AC power ground where you install the Switch must follow your country's regulations. Qualified service personnel must ensure the building's protective earthing terminals are valid terminals.

Installation of Ethernet cables must be separate from AC power lines. To avoid electric surge and electromagnetic interference, use a different electrical conduit or raceway (tube/trough or enclosed conduit for protecting electric wiring) that is 15 cm apart, or as specified by your country's electrical regulations.

Any device that is located outdoors and connected to this product must be properly grounded and surge protected. To the extent permissible by your country's applicable law, failure to follow these guidelines could result in damage to your Switch which may not be covered by its warranty.

Note: The specification for surge or ESD protection assumes that the Switch is properly grounded.

- 1 Remove the M4 ground screw from the Switch's rear panel.
- 2 Secure a green or yellow ground cable (16 AWG or smaller) to the Switch's rear panel using the M4 ground screw.

Figure 27 Grounding

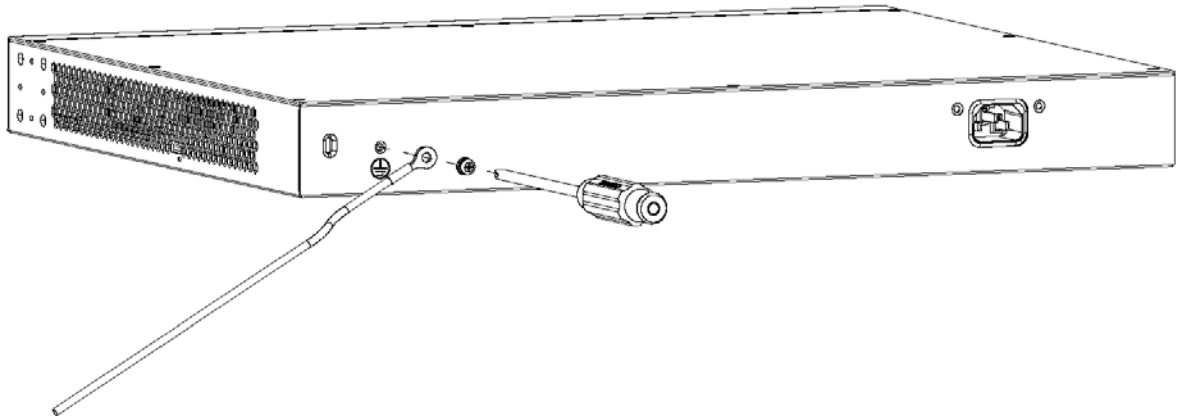

- 3 Attach the other end of the ground cable to a grounding bar located on the rack where you install the Switch or to an on-site grounding terminal.

Figure 28 Attach Ground Cable to Grounding Bar or On-site Grounding Terminal

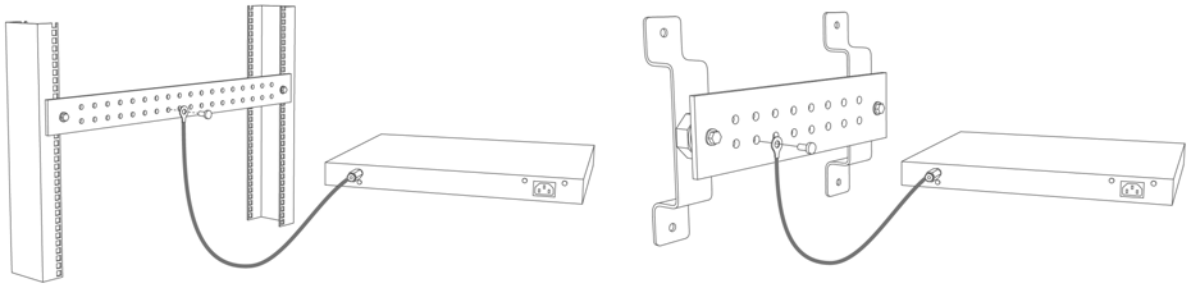

- 4 The grounding terminal of the server rack or on-site grounding terminal must also be grounded and connected to the building's main grounding electrode. Make sure the grounding terminal is connected to the buildings grounding electrode and has an earth resistance of less than 10 ohms, or according to your country's electrical regulations.

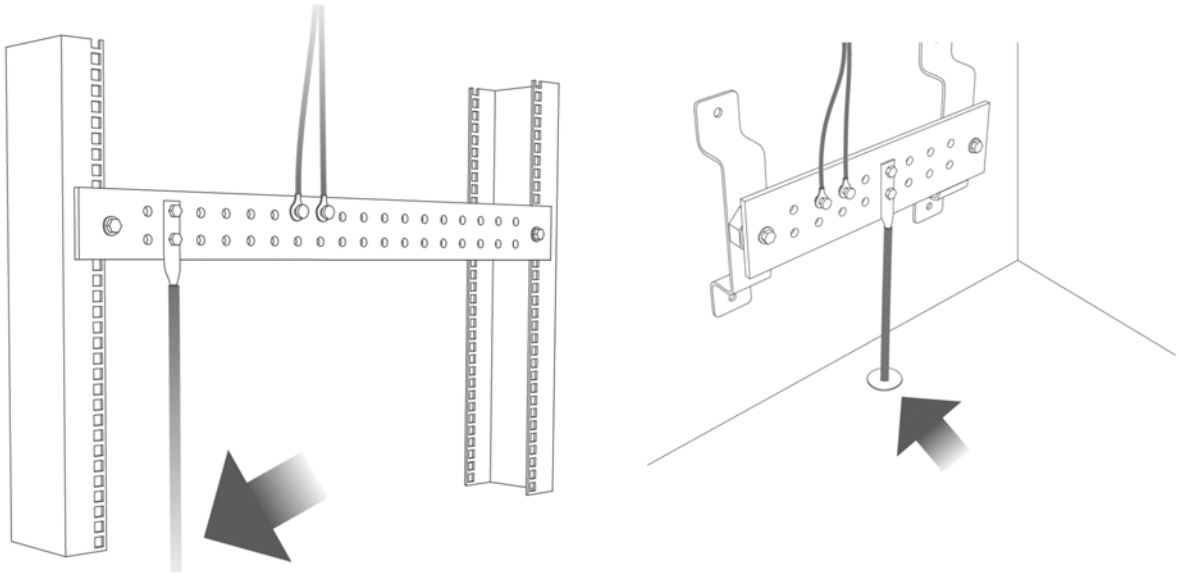
Figure 29 Connecting to the Building's Main Grounding Electrode

If you are uncertain that suitable grounding is available, contact the appropriate electrical inspection authority or an electrician.

This device must be grounded. Do this before you make other connections.

3.2.2 AC Power Connection

Note: Make sure you are using the correct power source as shown on the panel and that no objects obstruct the airflow of the fans (located on the side of the unit).

To connect power to the Switch, insert the female end of the power cord to the AC power receptacle on the rear panel. Connect the other end of the supplied power cord to a power outlet.

3.3 LEDs

Table 4 LED Descriptions

LED	COLOR	STATUS	DESCRIPTION
PWR	Green	On	The Switch is receiving power from the power module in the power slot.
		Blinking	The Switch is returning to the last-saved custom default configuration settings.
	Amber	On	The Switch is returning to its factory default configuration settings.
		Off	The Switch is not receiving power from the power module in the power slot.
SYS	Green	On	The Switch is on and functioning properly.
		Blinking	The Switch is rebooting and performing self-diagnostic tests.
	Red	On	The Switch is functioning abnormally.
		Off	The power is off or the Switch is not ready or malfunctioning.

Table 4 LED Descriptions (continued)

LED	COLOR	STATUS	DESCRIPTION	
CLOUD	Green	On	The Switch has successfully connected to the NCC (Nebula Control Center).	
		Blinking	The Switch cannot connect to the NCC because it is not registered.	
	Amber	On	The Switch is registered at NCC but cannot connect to the NCC. Please check the Internet connection of the Switch.	
		Blinking	The Switch is not registered at NCC and cannot connect to the NCC. Please check the Internet connection of the Switch and register the Switch at NCC.	
	Off	The Switch is operating in standalone mode. Nebula Control Center Discovery is disabled in Basic Setting > Cloud Management > Nebula Control Center Discovery in the Switch Web Configurator.		
LOCATOR	Blue	On	The Switch is uploading firmware. While the Switch is doing this, do not turn off the power.	
		Blinking	Shows the actual location of the Switch between several devices in a rack. The default timer is 30 minutes when you are configuring the Switch.	
		Off	The locator is not functioning or malfunctioning.	
PoE Usage MAX (GS1920-8HPv2) Bar1 is the bar at the bottom; bar 5 is the bar at the top.	Green (Bar1-Bar3)	On	Each bar represents 20% of PoE Power consumption. Bar 1: PoE power usage is below 20 percent of the power supplied budget. Bar 2: PoE power usage is below 40 percent of the power supplied budget, but over 20 percent of the power supplied budget. Bar 3: PoE power usage is below 60 percent of the power supplied budget, but over 40 percent of the power supplied budget.	
		Yellow (Bar4)	On	PoE power usage is below 80 percent of the power supplied budget, but over 60 percent of the power supplied budget.
		Red (Bar5)	On	PoE power usage is more than 80 percent of the power supplied budget or exceeds the PoE Usage Threshold (%) configured in PoE Setting .
	Blinking		Less than 5 percent of the power supplied budget remains. 5 percent is the default value.	
		Off	PoE power usage is 0 percent of the power supplied budget.	
PoE MAX (GS1920-24HPv2 & GS1920-48HPv2)	Amber	On	Less than 5 percent of the power supplied budget remains. 5 percent is the default value.	
		Off	The Switch has a sufficient power supplied budget.	
Ethernet Ports and PoE				
LNK/ACT 1 – 8 (GS1920-8HPv2) 1 – 24 (GS1920-24v2/24HPv2) and 1 – 48 (GS1920-48v2/48HPv2)	Green	Blinking	The Switch is transmitting or receiving to or from a 1000 Mbps Ethernet network.	
		On	The link to a 1000 Mbps Ethernet network is up.	
	Amber	Blinking	The Switch is transmitting or receiving to or from a 10 Mbps or a 100 Mbps Ethernet network.	
		On	The link to a 10 Mbps or a 100 Mbps Ethernet network is up.	
	Off	The link to an Ethernet network is down.		

Table 4 LED Descriptions (continued)

LED	COLOR	STATUS	DESCRIPTION
PoE	Green	On	Power supplied to all PoE Ethernet ports meets the IEEE 802.3at standard.
1 – 8 (GS1920-8HPv2)	Amber	On	Power supplied to all PoE Ethernet ports meets the IEEE 802.3af standard.
1 – 24 (GS1920-24HPv2)		Off	There is no power supplied.
1 – 48 (GS1920-48HPv2)			
Dual Personality Interface			
Ethernet Ports 9 – 10 (GS1920-8HPv2) 25 – 28 (GS1920-24v2/24HPv2) 45 – 48 (GS1920-48v2/48HPv2)	Green	Blinking	The Switch is transmitting or receiving to or from a 1000 Mbps Ethernet network.
		On	The link to a 1000 Mbps Ethernet network is up.
	Amber	Blinking	The Switch is transmitting or receiving to or from a 10 Mbps or a 100 Mbps Ethernet network.
		On	The link to a 10 Mbps or a 100 Mbps Ethernet network is up.
		Off	The link to an Ethernet network is down.
	SFP Slots 9 – 10 (GS1920-8HPv2) 25 – 28 (GS1920-24v2/24HPv2) 45 – 48 (GS1920-48v2/48HPv2)	Green	On
Blinking			The Switch is transmitting or receiving data 1000 Mbps.
Amber		On	The uplink port is linking at 100 Mbps.
		Blinking	The Switch is transmitting or receiving data 100 Mbps.
		Off	There is no link or port, the uplink port is shut down.
SFP Slots			
49 – 50 (GS1920-48v2/48HPv2)	Green	On	The uplink port is linking at 1000 Mbps.
		Blinking	The Switch is transmitting or receiving data 1000 Mbps.
	Amber	On	The uplink port is linking at 100 Mbps.
		Blinking	The Switch is transmitting or receiving data 100 Mbps.
		Off	There is no link or port, the uplink port is shut down.

PART II

Technical Reference

CHAPTER 4

Web Configurator

4.1 Overview

This section introduces the configuration and functions of the Web Configurator.

The Web Configurator is an HTML-based management interface that allows easy system setup and management via Internet browser. Use a browser that supports HTML5, such as Microsoft Edge, Internet Explorer 11, Mozilla Firefox, or Google Chrome. The recommended screen resolution is 1024 by 768 pixels.

In order to use the Web Configurator you need to allow:

- Web browser pop-up windows from your device.
- JavaScript (enabled by default).
- Java permissions (enabled by default).

4.2 System Login

- 1 Start your web browser.
- 2 The Switch is a DHCP client by default. Type "http://DHCP-assigned IP" in the **Location** or **Address** field. Press [ENTER].

If the Switch is not connected to a DHCP server, type "http://" and the static IP address of the Switch (for example, the default management IP address is 192.168.1.1) in the **Location** or **Address** field. Press [ENTER]. Your computer must be in the same subnet in order to access this website address.

Also, you can use the ZON Utility to check your Switch's IP address. See [Section 4.3 on page 49](#) for more information on the ZON utility.
- 3 The following screen appears.

Figure 30 Web Configurator: Login

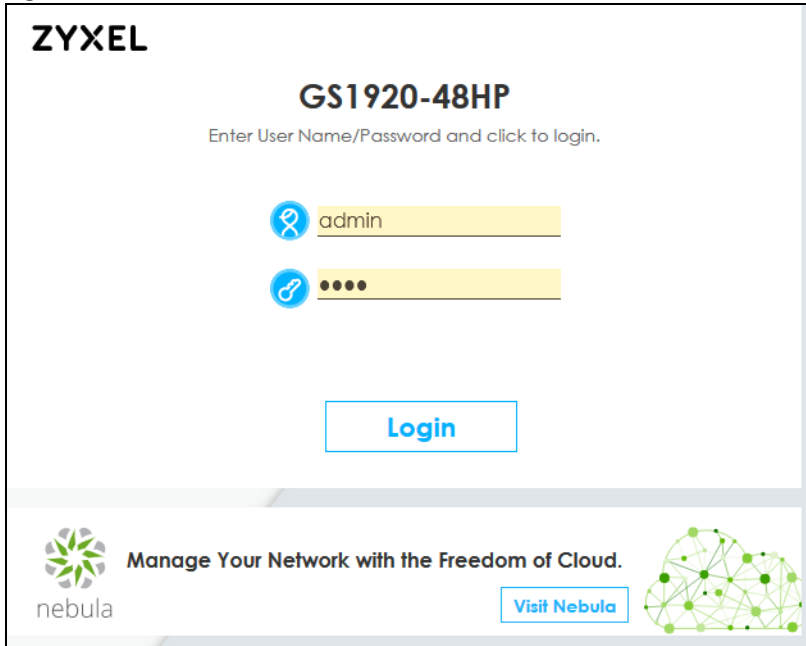

The image shows the login page for the ZYXEL GS1920-48HP Web Configurator. At the top, the ZYXEL logo is on the left, and the model number GS1920-48HP is centered. Below the model number, it says "Enter User Name/Password and click to login." There are two input fields: the first is for the username, with "admin" entered, and the second is for the password, with four dots representing the masked characters. A blue "Login" button is centered below the fields. At the bottom, there is a banner for "nebula" with the text "Manage Your Network with the Freedom of Cloud." and a "Visit Nebula" button next to a network diagram icon.

- 4 Click **Login** to log into the Web Configurator to manage the Switch directly. The default user name is **admin** and associated default password is **1234**.
- 5 If you did not change the default administrator password and/or SNMP community values, a warning screen displays each time you log into the Web Configurator. Click **Password / SNMP** to open a screen where you can change the administrator password and SNMP community string simultaneously. Otherwise, click **Ignore** to close it.

Password/SNMP Setting

Figure 31 Web Configurator: Warning

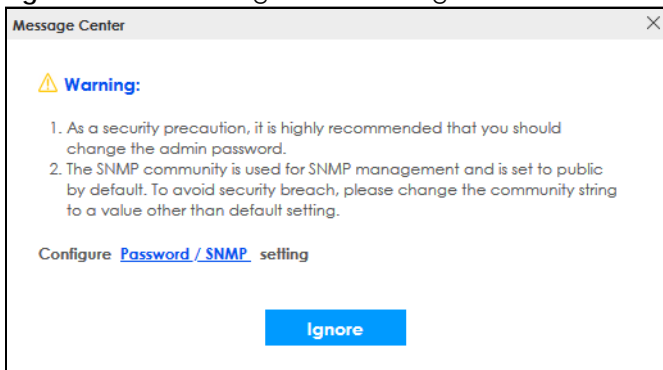

The image shows a "Message Center" window with a warning icon and the text "Warning:". Below the warning, there are two numbered points: "1. As a security precaution, it is highly recommended that you should change the admin password." and "2. The SNMP community is used for SNMP management and is set to public by default. To avoid security breach, please change the community string to a value other than default setting." At the bottom, there is a link "Configure Password / SNMP setting" and a blue "Ignore" button.

Figure 32 Web Configurator: Password

The screenshot shows the 'Password' and 'SNMP' configuration sections. The 'Password' section has three input fields: 'Old Password' (containing four dots), 'New Password', and 'Retype to confirm'. The 'SNMP' section is under 'General Setting' and includes a 'Version' dropdown menu set to 'v2c', and three text boxes for 'Get Community', 'Set Community', and 'Trap Community', each containing the text 'public'. At the bottom of the form are 'Apply' and 'Cancel' buttons.

Change the default administrator and/or SNMP passwords, and then click **Apply** to save your changes.

Table 5 Web Configurator: Password/SNMP

LABEL	DESCRIPTION
Administrator	This is the default administrator account with the "admin" user name. You cannot change the default administrator user name.
Old Password	Type the existing system password (1234 is the default password when shipped).
New Password	Enter your new system password.
Retype to confirm	Retype your new system password for confirmation.
General Setting	Use this section to specify the SNMP version and community (password) values.
Version	Select the SNMP version for the Switch. The SNMP version on the Switch must match the version on the SNMP manager. Choose SNMP version 2c (v2c), SNMP version 3 (v3) or both (v3v2c). Note: SNMP version 2c is backwards compatible with SNMP version 1.
Get Community	Enter the Get Community string, which is the password for the incoming Get- and GetNext-requests from the management station. The Get Community string is only used by SNMP managers using SNMP version 2c or lower.
Set Community	Enter the Set Community string, which is the password for the incoming Set- requests from the management station. The Set Community string is only used by SNMP managers using SNMP version 2c or lower.
Trap Community	Enter the Trap Community string, which is the password sent with each trap to the SNMP manager. The Trap Community string is only used by SNMP managers using SNMP version 2c or lower.
Apply	Click Apply to save your changes to the Switch's run-time memory. The Switch loses these changes if it is turned off or loses power, so use the Save link on the top navigation panel to save your changes to the non-volatile memory when you are done configuring.
Cancel	Click Cancel to begin configuring this screen afresh.

4.3 Zyxel One Network (ZON) Utility

ZON Utility is a program designed to help you deploy and manage a network more efficiently. It detects devices automatically and allows you to do basic settings on devices in the network without having to be near it.

The ZON Utility issues requests via Zyxel Discovery Protocol (ZDP) and in response to the query, the device responds back with basic information including IP address, firmware version, location, system and model name in the same broadcast domain. The information is then displayed in the ZON Utility screen and you can perform tasks like basic configuration of the devices and batch firmware upgrade in it. You can download the ZON Utility at www.zyxel.com and install it on a computer (Windows operating system).

4.3.1 Requirements

Before installing the ZON Utility on your computer, please make sure it meets the requirements listed below.

Operating System

At the time of writing, the ZON Utility is compatible with:

- Windows 7 (both 32-bit / 64-bit versions)
- Windows 8 (both 32-bit / 64-bit versions)
- Windows 8.1 (both 32-bit / 64-bit versions)
- Windows 10 (both 32-bit / 64-bit versions)

Note: To check for your Windows operating system version, right-click on **My Computer > Properties**. You should see this information in the **General** tab.

Hardware

Here are the minimum hardware requirements to use the ZON Utility on your computer.

- Core i3 processor
- 2 GB RAM
- 100 MB free hard disk
- WXGA (Wide XGA 1280 by 800)

4.3.2 Run the ZON Utility

- 1 Double-click the ZON Utility to run it.
- 2 The first time you run the ZON Utility, you will see if your device and firmware version support the ZON Utility. Click the **OK** button to close this screen.

Figure 33 Supported Devices and Versions

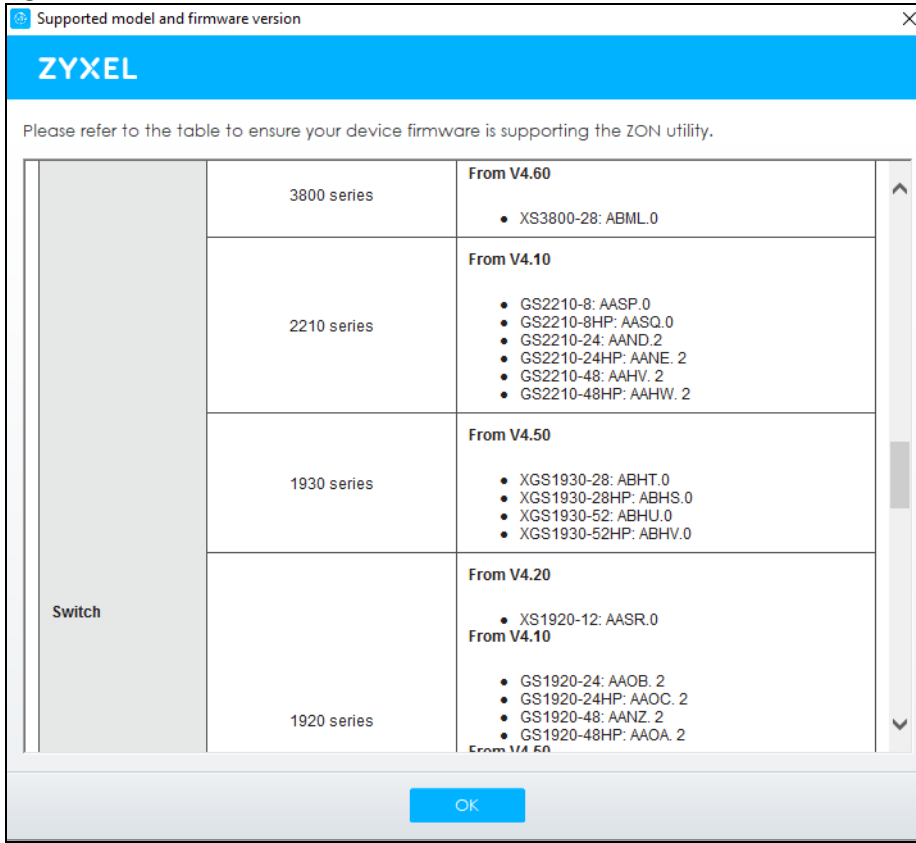

If you want to check the supported models and firmware versions later, you can click the **Show information about ZON** icon in the upper right hand corner of the screen. Then select the **Supported model and firmware version** link. If your device is not listed here, see the device release notes for ZON Utility support. The release notes are in the firmware zip file on the Zyxel web site.

Figure 34 ZON Utility Screen

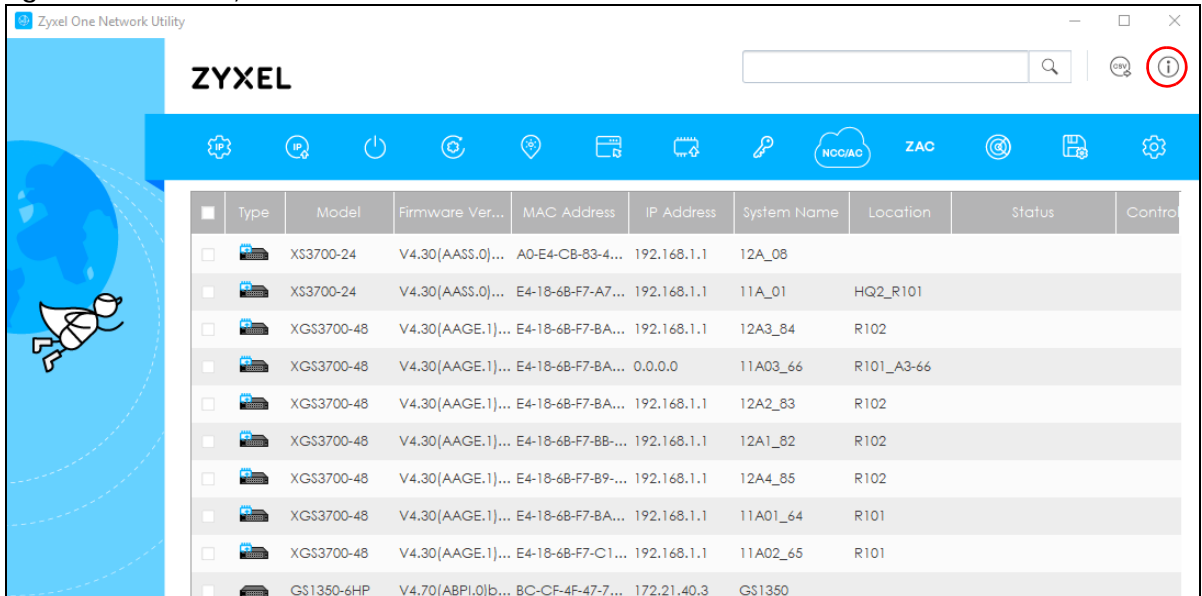

- 3 Select a network adapter to which your supported devices are connected.

Figure 35 Network Adapter

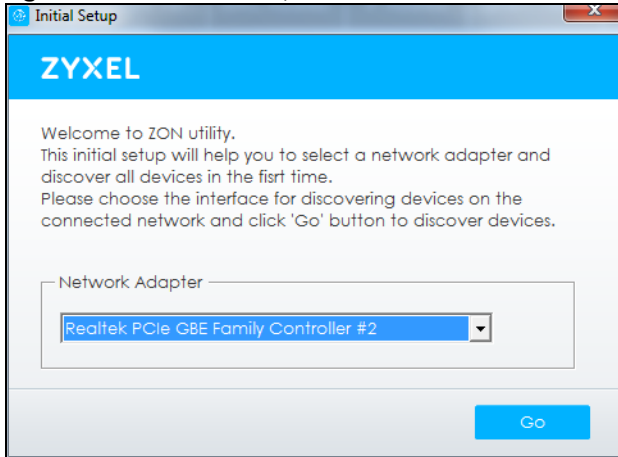

- 4 Click the **Go** button for the ZON Utility to discover all supported devices in your network.

Figure 36 Discovery

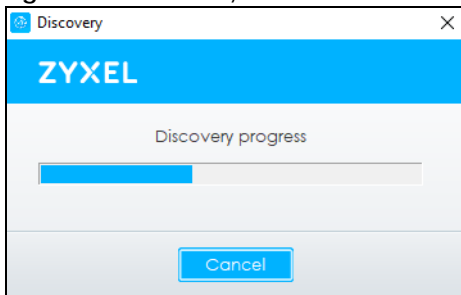

- 5 The ZON Utility screen shows the devices discovered.

Figure 37 ZON Utility Screen

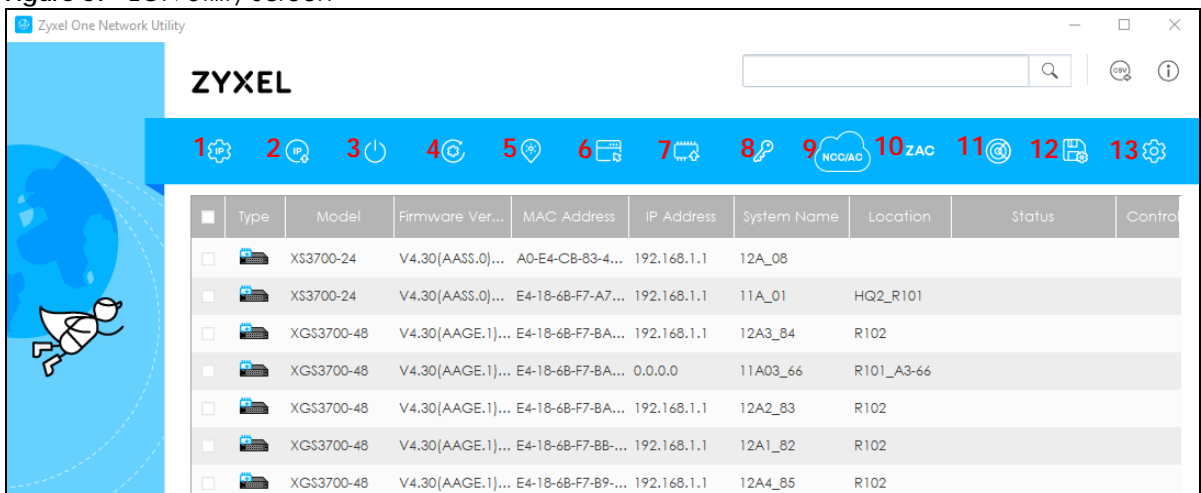

- 6 Select a device and then use the icons to perform actions. Some functions may not be available for your devices.

Note: You must know the selected device admin password before taking actions on the device using the ZON Utility icons.

Figure 38 Password Prompt

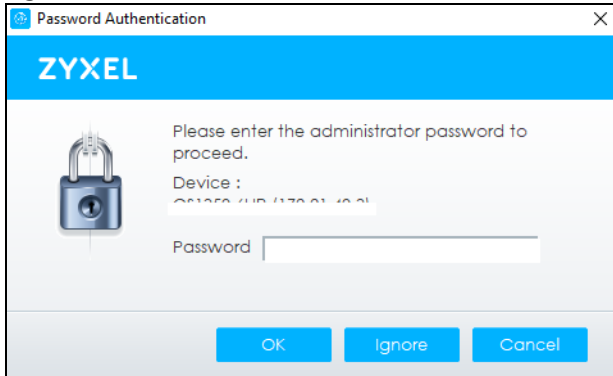

The following table describes the icons numbered from left to right in the ZON Utility screen.

Table 6 ZON Utility Icons

ICON	DESCRIPTION
1 IP Configuration	Change the selected device's IP address.
2 Renew IP Address	Update a DHCP-assigned dynamic IP address.
3 Reboot Device	Use this icon to restart the selected devices. This may be useful when troubleshooting or upgrading new firmware.
4 Reset Configuration to Default	Use this icon to reload the factory-default configuration file. This means that you will lose all previous configurations.
5 Locator LED	Use this icon to locate the selected device by causing its Locator LED to blink.
6 Web GUI	Use this to access the selected device Web Configurator from your browser. You will need a user name and password to log in.
7 Firmware Upgrade	Use this icon to upgrade new firmware to selected devices of the same model. Make sure you have downloaded the firmware from the Zyxel website to your computer and unzipped it in advance.
8 Change Password	Use this icon to change the admin password of the selected device. You must know the current admin password before changing to a new one.
9 Configure NCC Discovery	You must have Internet access to use this feature. Use this icon to enable or disable the Nebula Control Center (NCC) discovery feature on the selected device. If it is enabled, the selected device will try to connect to the NCC. Once the selected device is connected to and has registered in the NCC, it will go into the Nebula cloud management mode.
10 ZAC	Use this icon to run the Zyxel AP Configurator of the selected AP.
11 Clear and Rescan	Use this icon to clear the list and discover all devices on the connected network again.
12 Save Configuration	Use this icon to save configuration changes to permanent memory on a selected device.
13 Settings	Use this icon to select a network adapter for the computer on which the ZON utility is installed, and the utility language.

The following table describes the fields in the ZON Utility main screen.

Table 7 ZON Utility Fields

LABEL	DESCRIPTION
Type	This field displays an icon of the kind of device discovered.
Model	This field displays the model name of the discovered device.
Firmware Version	This field displays the firmware version of the discovered device.
MAC Address	This field displays the MAC address of the discovered device.

Table 7 ZON Utility Fields (continued)

LABEL	DESCRIPTION
IP Address	This field displays the IP address of an internal interface on the discovered device that first received an ZDP discovery request from the ZON Utility.
System Name	This field displays the system name of the discovered device.
Location	This field displays where the discovered device is.
Status	This field displays whether changes to the discovered device have been done successfully. As the Switch does not support IP Configuration, Renew IP address and Flash Locator LED , this field displays "Update failed", "Not support Renew IP address" and "Not support Flash Locator LED" respectively.
Controller Discovery	This field displays if the discovered device supports the Nebula Control Center (NCC) discovery feature. If it is enabled, the selected device will try to connect to the NCC. Once the selected device is connected to and has registered in the NCC, it will go into the Nebula cloud management mode.
Serial Number	Enter the admin password of the discovered device to display its serial number.
Hardware Version	This field displays the hardware version of the discovered device.

4.4 Web Configurator Layout

The **Status** screen is the first screen that displays when you access the Web Configurator.

The following figure shows the navigating components of a Web Configurator screen.

Figure 39 Web Configurator Home Screen (Status)

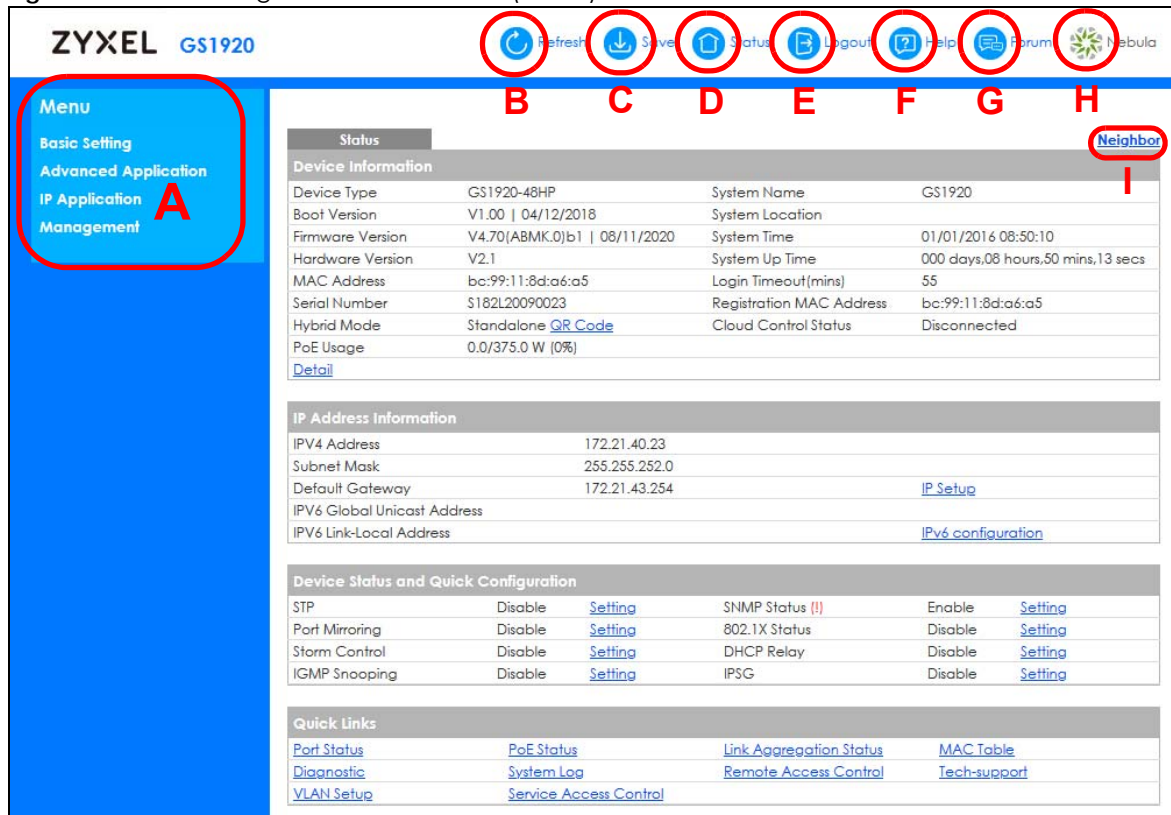

A – Click the menu items to open sub-menu links, and then click on a sub-menu link to open the screen in the main window.

B, C, D, E, F – These are quick links which allow you to perform certain tasks no matter which screen you are currently working in.

B – Click this link to update the information in the screen you are viewing currently.

C – Click this link to save your configuration into the Switch's non-volatile memory. Non-volatile memory is the configuration of your Switch that stays the same even if the Switch's power is turned off.

D – Click this link to go to the status page of the Switch.

E – Click this link to log out of the Web Configurator.

F – Click this link to display web help pages. The help pages provide descriptions for all of the configuration screens.

G – Click this link to go to the Zyxel Community Biz Forum.

H – Click this link to go to the NCC (Nebula Control Center) portal website.

I – Click this link to go to the **Neighbor** screen where you can see and manage neighbor devices learned by the Switch.

In the navigation panel, click a main link to reveal a list of sub-menu links.

Table 8 Navigation Panel Sub-links Overview

BASIC SETTING	ADVANCED APPLICATION	IP APPLICATION	MANAGEMENT
Menu Basic Setting Advanced Application IP Application Management System Info General Setup Switch Setup IP Setup Port Setup PoE Setup Interface Setup IPv6 Cloud Management	Menu Basic Setting Advanced Application IP Application Management VLAN Static MAC Forwarding Static Multicast Forwarding Filtering Spanning Tree Protocol Bandwidth Control Broadcast Storm Control Mirroring Link Aggregation Port Authentication Port Security Time Range Classifier Policy Rule Queuing Method Multicast AAA IP Source Guard Loop Guard Layer 2 Protocol Tunneling PPPoE Erddisable Vlan Isolation Green Ethernet LLDP OAM	Menu Basic Setting Advanced Application IP Application Management Static Routing DiffServ DHCP ARP Setup	Menu Basic Setting Advanced Application IP Application Management Maintenance Access Control Diagnostic System Log Syslog Setup Cluster Management MAC Table ARP Table Path MTU Table Configure Clone IPv6 Neighbor Table Port Status

The following table describes the links in the navigation panel.

Table 9 Navigation Panel Links

LINK	DESCRIPTION
Basic Setting	
System Info	This link takes you to a screen that displays general system information.
General Setup	This link takes you to a screen where you can configure general identification information about the Switch.
Switch Setup	This link takes you to a screen where you can set up global Switch parameters such as VLAN type and priority queues.
IP Setup	This link takes you to a screen where you can configure the IP address and subnet mask (necessary for Switch management) and set up to 64 IP routing domains.
Port Setup	This link takes you to a screen where you can configure settings for individual Switch ports.
PoE Setup	For PoE models. This link takes you to a screen where you can set priorities, PoE power-up settings and schedule so that the Switch is able to reserve and allocate power to certain PDs.
Interface Setup	This link takes you to a screen where you can configure settings for individual interface type and ID.
IPv6	This link takes you to a screen where you can view IPv6 status and configure IPv6 settings.

Table 9 Navigation Panel Links (continued)

LINK	DESCRIPTION
Cloud Management	This screen displays a link to a screen where you can enable or disable the Nebula Control Center Discovery feature. If it is enabled, you can have the Switch search for the NCC (Nebula Control Center). Another link takes you to the Nebula Switch Registration screen which has a QR code containing the Switch's serial number and MAC address for handy registration of the Switch at NCC.
Advanced Application	
VLAN	This link takes you to screens where you can configure port-based or 802.1Q VLAN (depending on what you configured in the Switch Setup menu). You can also configure a voice VLAN, a MAC based VLAN or a vendor ID based VLAN in these screens.
Static MAC Forwarding	This link takes you to a screen where you can configure static MAC addresses for a port. These static MAC addresses do not age out.
Static Multicast Forwarding	This link takes you to a screen where you can configure static multicast MAC addresses for ports. These static multicast MAC addresses do not age out.
Filtering	This link takes you to a screen to set up filtering rules.
Spanning Tree Protocol	This link takes you to screens where you can configure the RSTP to prevent network loops.
Bandwidth Control	This link takes you to a screen where you can configure bandwidth limits on the Switch.
Broadcast Storm Control	This link takes you to a screen to set up broadcast filters.
Mirroring	This link takes you to screens where you can copy traffic from one port or ports to another port in order that you can examine the traffic from the first port without interference.
Link Aggregation	This link takes you to screens where you can logically aggregate physical links to form one logical, higher-bandwidth link.
Port Authentication	This link takes you to a screen where you can configure IEEE 802.1x port authentication as well as MAC authentication for clients communicating via the Switch.
Port Security	This link takes you to a screen where you can activate MAC address learning and set the maximum number of MAC addresses to learn on a port.
Time Range	This link takes you to a screen where you can define different schedules.
Classifier	This link takes you to screens where you can configure the Switch to group packets based on the specified criteria.
Policy Rule	This link takes you to a screen where you can configure the Switch to perform special treatment on the grouped packets.
Queuing Method	This link takes you to a screen where you can configure queuing with associated queue weights for each port.
Multicast	This link takes you to screens where you can configure various multicast features and IGMP snooping.
AAA	This link takes you to a screen where you can configure authentication, authorization and accounting services via external servers. The external servers should be RADIUS (Remote Authentication Dial-In User Service).
IP Source Guard	This link takes you to screens where you can configure filtering of unauthorized DHCP and ARP packets in your network.
Loop Guard	This link takes you to a screen where you can configure protection against network loops that occur on the edge of your network.
Layer 2 Protocol Tunneling	This link takes you to a screen where you can configure L2PT (Layer 2 Protocol Tunneling) settings on the Switch.
PPPoE	This link takes you to screens where you can configure how the Switch gives a PPPoE termination server additional subscriber information that the server can use to identify and authenticate a PPPoE client.

Table 9 Navigation Panel Links (continued)

LINK	DESCRIPTION
Errdisable	This link takes you to screens where you can view errdisable status and configure errdisable settings in CPU protection, errdisable detect, and errdisable recovery.
Vlan Isolation	This link takes you to a screen where you can block traffic between ports in a VLAN on the Switch.
Green Ethernet	This link takes you to a screen where you can configure green Ethernet settings in EEE, auto power down, and short reach for each port.
LLDP	This link takes you to screens where you can configure LLDP settings.
OAM	This link takes you to screens where you can enable Ethernet OAM on the Switch, view the configuration of ports on which Ethernet OAM is enabled and perform remote-loopback tests.
IP Application	
Static Routing	This link takes you to a screen where you can configure static routes. A static route defines how the Switch should forward traffic by configuring the TCP/IP parameters manually.
DiffServ	This link takes you to screens where you can enable DiffServ, configure marking rules and set DSCP-to-IEEE802.1p mappings.
DHCP	This link takes you to screens where you can configure the DHCP settings.
ARP Setup	This link takes you to screens where you can configure the ARP learning settings for each port.
Management	
Maintenance	This link takes you to screens where you can perform firmware and configuration file maintenance as well as reboot the system.
Access Control	This link takes you to screens where you can change the system login password and configure SNMP and remote management.
Diagnostic	This link takes you to a screen where you can ping IP addresses, run traceroute, test ports and show the Switch's location.
System Log	This link takes you to a screen where you can view system logs.
Syslog Setup	This link takes you to a screen where you can setup system logs and a system log server.
Cluster Management	This link takes you to screens where you can configure clustering management and view its status.
MAC Table	This link takes you to a screen where you can view the MAC addresses (and types) of devices attached to what ports and VLAN IDs.
ARP Table	This link takes you to a screen where you can view the MAC addresses – IP address resolution table.
Path MTU Table	This link takes you to a screen where you can view the path MTU aging time, index, destination address, MTU, and expire settings.
Configure Clone	This link takes you to a screen where you can copy attributes of one port to other ports.
IPv6 Neighbor Table	This link takes you to a screen where you can view the IPv6 neighbor table which includes index, interface, neighbor address, MAC address, status and type.
Port Status	This link takes you to a screen where you can view the port statistics.

4.4.1 Change Your Password

After you log in for the first time, it is recommended you change the default administrator password. Click **Management > Access Control > Logins** to display the next screen.

Figure 40 Change Administrator Login Password

Logins [Access Control](#)

Administrator

Old Password

New Password

Retype to confirm

Please record your new password whenever you change it. The system will lock you out if you have forgotten your password.

Edit Logins

Login	User Name	Password	Retype to confirm	Privilege
1	<input type="text"/>	<input type="text"/>	<input type="text"/>	<input type="text"/>
2	<input type="text"/>	<input type="text"/>	<input type="text"/>	<input type="text"/>
3	<input type="text"/>	<input type="text"/>	<input type="text"/>	<input type="text"/>
4	<input type="text"/>	<input type="text"/>	<input type="text"/>	<input type="text"/>

4.5 Save Your Configuration

When you are done modifying the settings in a screen, click **Apply** to save your changes back to the run-time memory. Settings in the run-time memory are lost when the Switch's power is turned off.

Click the **Save** link in the upper right hand corner of the Web Configurator to save your configuration to non-volatile memory. Non-volatile memory refers to the Switch's storage that remains even if the Switch's power is turned off.

Note: Use the **Save** link when you are done with a configuration session.

4.6 Switch Lockout

You could block yourself (and all others) from managing the Switch if you do one of the following:

- 1 Delete the management VLAN (default is VLAN 1).
- 2 Delete all port-based VLANs with the CPU port as a member. The "CPU port" is the management port of the Switch.
- 3 Filter all traffic to the CPU port.
- 4 Disable all ports.
- 5 Misconfigure the text configuration file.
- 6 Forget the password and/or IP address.

- 7 Prevent all services from accessing the Switch.
- 8 Change a service port number but forget it.
- 9 You forgot to log out of the Switch from a computer before logging in again on another computer.

Note: Be careful not to lock yourself and others out of the Switch. If you do lock yourself out, try using out-of-band management (via the management port) to configure the Switch.

4.7 Reset the Switch

If you lock yourself (and others) from the Switch or forget the administrator password, you will need to reload the factory-default configuration file or reset the Switch back to the factory defaults.

Press the **RESTORE** button for more than 7 seconds to have the Switch automatically reboot and restore the factory default file. See [Section 3.3 on page 42](#) for more information about the LED behavior.

4.7.1 Restore Custom Default

Press the **RESTORE** button for 3 to 7 seconds to have the Switch automatically reboot and restore the last-saved custom default file. See [Section 3.3 on page 42](#) for more information about the LED behavior.

4.7.2 Reboot the Switch

Press the **RESET** button to reboot the Switch without turning the power off. See [Section 3.3 on page 42](#) for more information about the LED behavior.

4.8 Log Out of the Web Configurator

Click **Logout** in a screen to exit the Web Configurator. You have to log in with your password again after you log out. This is recommended after you finish a management session for security reasons.

Figure 41 Web Configurator: Logout Screen

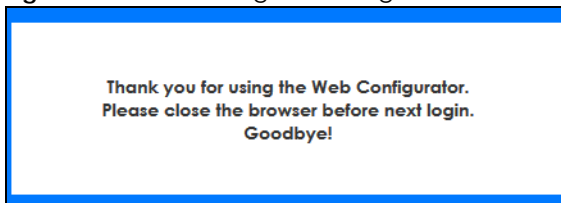

4.9 Help

The Web Configurator's online help has descriptions of individual screens and some supplementary information.

Click the **Help** link from a Web Configurator screen to view an online help description of that screen.

CHAPTER 5

Initial Setup Example

5.1 Overview

This chapter shows how to set up the Switch for an example network.

The following lists the configuration steps for the initial setup:

- [Create a VLAN](#)
- [Set Port VID](#)
- [Configure Switch Management IP Address](#)

5.1.1 Create a VLAN

VLANs confine broadcast frames to the VLAN group in which the ports belongs. You can do this with port-based VLAN or tagged static VLAN with fixed port members.

In this example, you want to configure port 1 as a member of VLAN 2.

Figure 42 Initial Setup Network Example: VLAN

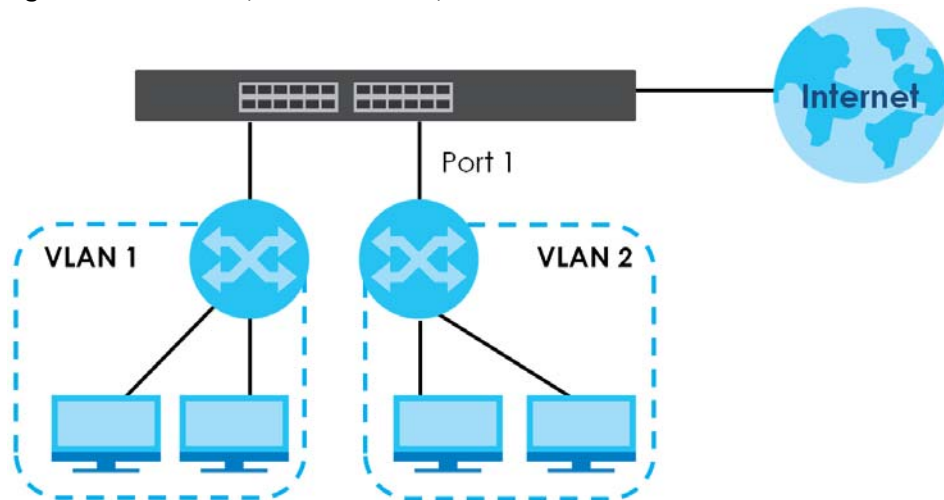

- 1 Click **Advanced Application > VLAN > VLAN Configuration** in the navigation panel and click the **Static VLAN Setup** link.

VLAN Configuration		VLAN Status
Static VLAN Setup	Click Here	
VLAN Port Setup	Click Here	
Subnet Based VLAN Setup	Click Here	
Protocol Based VLAN Setup	Click Here	
Voice VLAN Setup	Click Here	
MAC Based VLAN Setup	Click Here	
Vendor ID Based VLAN Setup	Click Here	

- 2 In the **Static VLAN** screen, select **ACTIVE**, enter a descriptive name in the **Name** field and enter 2 in the **VLAN Group ID** field for the **VLAN2** network.

Static VLAN		VLAN Configuration
ACTIVE	<input checked="" type="checkbox"/>	
Name	Example	
VLAN Group ID	2	

Port	Control			Tagging
*		Normal	▼	<input checked="" type="checkbox"/> Tx Tagging
1	<input type="radio"/> Normal	<input checked="" type="radio"/> Fixed	<input type="radio"/> Forbidden	<input type="checkbox"/> Tx Tagging
2	<input checked="" type="radio"/> Normal	<input type="radio"/> Fixed	<input type="radio"/> Forbidden	<input checked="" type="checkbox"/> Tx Tagging
3	<input checked="" type="radio"/> Normal	<input type="radio"/> Fixed	<input type="radio"/> Forbidden	<input checked="" type="checkbox"/> Tx Tagging
4	<input checked="" type="radio"/> Normal	<input type="radio"/> Fixed	<input type="radio"/> Forbidden	<input checked="" type="checkbox"/> Tx Tagging
5	<input checked="" type="radio"/> Normal	<input type="radio"/> Fixed	<input type="radio"/> Forbidden	<input checked="" type="checkbox"/> Tx Tagging
6	<input checked="" type="radio"/> Normal	<input type="radio"/> Fixed	<input type="radio"/> Forbidden	<input checked="" type="checkbox"/> Tx Tagging
7	<input checked="" type="radio"/> Normal	<input type="radio"/> Fixed	<input type="radio"/> Forbidden	<input checked="" type="checkbox"/> Tx Tagging
8	<input checked="" type="radio"/> Normal	<input type="radio"/> Fixed	<input type="radio"/> Forbidden	<input checked="" type="checkbox"/> Tx Tagging
9	<input checked="" type="radio"/> Normal	<input type="radio"/> Fixed	<input type="radio"/> Forbidden	<input checked="" type="checkbox"/> Tx Tagging

VID	Active	Name	<input type="checkbox"/>
1	Yes	1	<input type="checkbox"/>
10	Yes	10	<input type="checkbox"/>
20	Yes	20	<input type="checkbox"/>
30	Yes	30	<input type="checkbox"/>
40	Yes	40	<input type="checkbox"/>
100	Yes	100	<input type="checkbox"/>

Note: The **VLAN Group ID** field in this screen and the **VID** field in the **IP Setup** screen refer to the same VLAN ID.

- 3 Since the **VLAN2** network is connected to port 1 on the Switch, select **Fixed** to configure port 1 to be a permanent member of the VLAN only.
- 4 To ensure that VLAN-unaware devices (such as computers and hubs) can receive frames properly, clear the **TX Tagging** check box to set the Switch to remove VLAN tags before sending.

- Click **Add** to save the settings to the run-time memory. Settings in the run-time memory are lost when the Switch's power is turned off.

5.1.2 Set Port VID

Use PVID to add a tag to incoming untagged frames received on that port so that the frames are forwarded to the VLAN group that the tag defines.

In the example network, configure 2 as the port VID on port 1 so that any untagged frames received on that port get sent to VLAN 2.

Figure 43 Initial Setup Network Example: Port VID

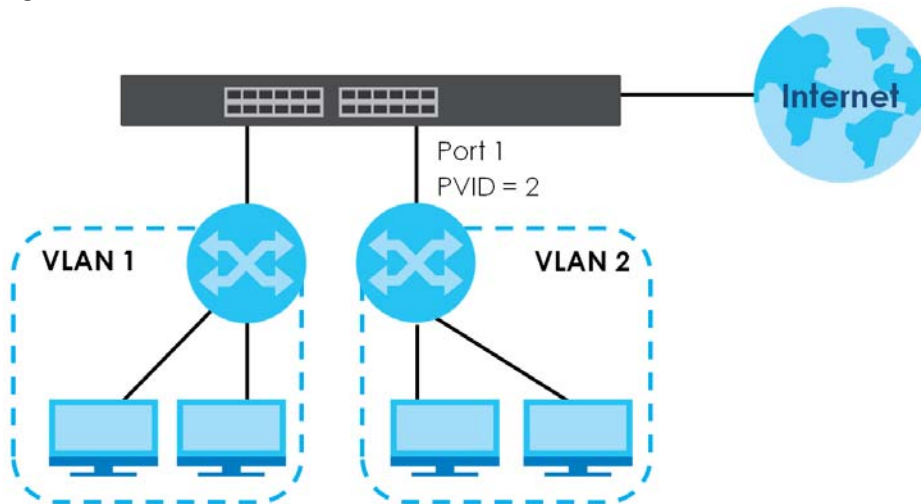

- Click **Advanced Applications > VLAN > VLAN Configuration** in the navigation panel. Then click the **VLAN Port Setup** link.
- Enter 2 in the **PVID** field for port 1 and click **Apply** to save your changes back to the run-time memory. Settings in the run-time memory are lost when the Switch's power is turned off.

Port	Ingress Check	PVID	GVRP	Acceptable Frame Type	VLAN Trunking	Isolation
1	<input type="checkbox"/>	2	<input type="checkbox"/>	All	<input type="checkbox"/>	<input type="checkbox"/>
2	<input type="checkbox"/>	1	<input type="checkbox"/>	All	<input type="checkbox"/>	<input type="checkbox"/>
3	<input type="checkbox"/>	1	<input type="checkbox"/>	All	<input type="checkbox"/>	<input type="checkbox"/>
4	<input type="checkbox"/>	1	<input type="checkbox"/>	All	<input type="checkbox"/>	<input type="checkbox"/>
5	<input type="checkbox"/>	1	<input type="checkbox"/>	All	<input type="checkbox"/>	<input type="checkbox"/>
6	<input type="checkbox"/>	1	<input type="checkbox"/>	All	<input type="checkbox"/>	<input type="checkbox"/>
7	<input type="checkbox"/>	1	<input type="checkbox"/>	All	<input type="checkbox"/>	<input type="checkbox"/>
8	<input type="checkbox"/>	1	<input type="checkbox"/>	All	<input type="checkbox"/>	<input type="checkbox"/>

5.1.3 Configure Switch Management IP Address

If the Switch fails to obtain an IP address from a DHCP server, the Switch will use 192.168.1.1 as the management IP address. You can configure another IP address in a different subnet for management purposes. The following figure shows an example.

Figure 44 Initial Setup Example: Management IP Address

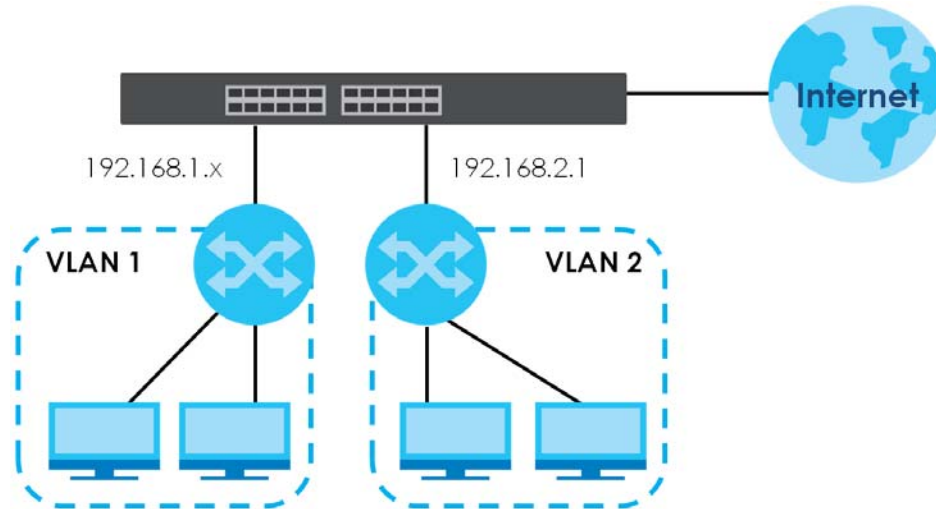

- 1 Connect your computer to any Ethernet port on the Switch. Make sure your computer is in the same subnet as the Switch.
- 2 Open your web browser and enter 192.168.1.1 (the default IP address) in the address bar to access the Web Configurator. See [Section 4.2 on page 46](#) for more information.
- 3 Click **Basic Setting** > **IP Setup** > **IP Configuration** in the navigation panel.

IP Setup		IP Status	Network Proxy Configuration
Domain Name Server 1	<input type="text"/>		
Domain Name Server 2	<input type="text"/>		
Default Management IP Address			
<input checked="" type="radio"/> DHCP Client			
Option-60	<input checked="" type="checkbox"/>		
Class-ID	<input type="text" value="Zyxel Corporatio"/>		
<input type="radio"/> Static IP Address			
IP Address	<input type="text" value="172.21.40.39"/>		
IP Subnet Mask	<input type="text" value="255.255.252.0"/>		
Default Gateway	<input type="text" value="172.21.43.254"/>		
VID	<input type="text" value="1"/>		
<input type="button" value="Apply"/> <input type="button" value="Cancel"/>			
Management IP Addresses			
IP Address	<input type="text" value="192.168.2.1"/>		
IP Subnet Mask	<input type="text" value="255.255.255.0"/>		
VID	<input type="text" value="2"/>		
Default Gateway	<input type="text" value="0.0.0.0"/>		
<input type="button" value="Add"/> <input type="button" value="Cancel"/>			
Index	IP Address	IP Subnet Mask	VID
			<input type="checkbox"/>
<input type="button" value="Delete"/> <input type="button" value="Cancel"/>			

- 4** Configure the related fields in the **IP Setup** screen.
- 5** For the **VLAN2** network, enter 192.168.2.1 as the IP address and 255.255.255.0 as the subnet mask.
- 6** In the **VID** field, enter the ID of the VLAN group to which you want this management IP address to belong. This is the same as the VLAN ID you configure in the **Static VLAN** screen.
- 7** Click **Add** to save your changes back to the run-time memory. Settings in the run-time memory are lost when the Switch's power is turned off.

CHAPTER 6

Tutorials

6.1 Overview

This chapter provides some examples of using the Web Configurator to set up and use the Switch. The tutorials include:

- [How to Use DHCPv4 Snooping on the Switch](#)
- [How to Use DHCPv4 Relay on the Switch](#)

6.2 How to Use DHCPv4 Snooping on the Switch

You only want DHCP server **A** connected to port 4 to assign IP addresses to all devices in VLAN network (**V**). Create a VLAN containing ports 5, 6 and 7. Connect a computer **M** to the Switch for management.

Figure 45 Tutorial: DHCP Snooping Tutorial Overview

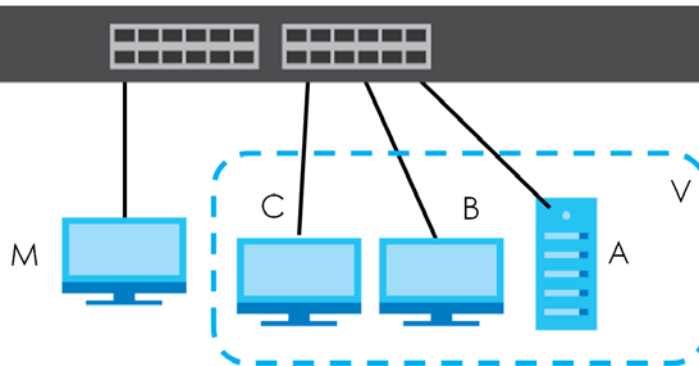

The settings in this tutorial are as the following.

Table 10 Tutorial: Settings in this Tutorial

HOST	PORT CONNECTED	VLAN	PVID	DHCP SNOOPING PORT TRUSTED
DHCP Server (A)	5	1 and 100	100	Yes
DHCP Client (B)	6	1 and 100	100	No
DHCP Client (C)	7	1 and 100	100	No

- 1 Access the Switch through <http://192.168.1.1> by default. Log into the Switch by entering the user name (default: **admin**) and password (default: **1234**).

- 2 Go to **Advanced Application > VLAN > VLAN Configuration > Static VLAN Setup**, and create a VLAN with ID of 100. Add ports 5, 6 and 7 in the VLAN by selecting **Fixed** in the **Control** field as shown.

De-select **Tx Tagging** because you do not want outgoing traffic to contain this VLAN tag.

Click **Add**.

Figure 46 Tutorial: Create a VLAN and Add Ports to It

The screenshot shows the 'Static VLAN' configuration page. At the top, there are fields for 'ACTIVE' (checked), 'Name' (VLAN 100), and 'VLAN Group ID' (100). Below this is a table with columns for 'Port', 'Control', and 'Tagging'. The 'Control' column has radio buttons for 'Normal', 'Fixed', and 'Forbidden'. The 'Tagging' column has a checkbox for 'Tx Tagging'. Ports 5, 6, and 7 are highlighted with a red circle, indicating they are selected for configuration. In this configuration, 'Fixed' is selected for 'Control' and 'Tx Tagging' is unchecked for these ports. At the bottom of the table, there are 'Add', 'Cancel', and 'Clear' buttons. The 'Add' button is circled in red. Below the table is a summary table with columns for 'VID', 'Active', and 'Name', showing a single entry for VID 1. At the very bottom, there are 'Delete' and 'Cancel' buttons.

Port	Control	Tagging
*	Normal	<input checked="" type="checkbox"/> Tx Tagging
1	<input checked="" type="radio"/> Normal <input type="radio"/> Fixed <input type="radio"/> Forbidden	<input checked="" type="checkbox"/> Tx Tagging
2	<input checked="" type="radio"/> Normal <input type="radio"/> Fixed <input type="radio"/> Forbidden	<input checked="" type="checkbox"/> Tx Tagging
3	<input checked="" type="radio"/> Normal <input type="radio"/> Fixed <input type="radio"/> Forbidden	<input checked="" type="checkbox"/> Tx Tagging
4	<input checked="" type="radio"/> Normal <input type="radio"/> Fixed <input type="radio"/> Forbidden	<input checked="" type="checkbox"/> Tx Tagging
5	<input type="radio"/> Normal <input checked="" type="radio"/> Fixed <input type="radio"/> Forbidden	<input type="checkbox"/> Tx Tagging
6	<input type="radio"/> Normal <input checked="" type="radio"/> Fixed <input type="radio"/> Forbidden	<input type="checkbox"/> Tx Tagging
7	<input type="radio"/> Normal <input checked="" type="radio"/> Fixed <input type="radio"/> Forbidden	<input type="checkbox"/> Tx Tagging
8	<input checked="" type="radio"/> Normal <input type="radio"/> Fixed <input type="radio"/> Forbidden	<input checked="" type="checkbox"/> Tx Tagging
9	<input checked="" type="radio"/> Normal <input type="radio"/> Fixed <input type="radio"/> Forbidden	<input checked="" type="checkbox"/> Tx Tagging
10	<input checked="" type="radio"/> Normal <input type="radio"/> Fixed <input type="radio"/> Forbidden	<input checked="" type="checkbox"/> Tx Tagging
48	<input checked="" type="radio"/> Normal <input type="radio"/> Fixed <input type="radio"/> Forbidden	<input checked="" type="checkbox"/> Tx Tagging
49	<input checked="" type="radio"/> Normal <input type="radio"/> Fixed <input type="radio"/> Forbidden	<input checked="" type="checkbox"/> Tx Tagging
50	<input checked="" type="radio"/> Normal <input type="radio"/> Fixed <input type="radio"/> Forbidden	<input checked="" type="checkbox"/> Tx Tagging

- 3 Go to **Advanced Application > VLAN > VLAN Configuration > VLAN Port Setup**, and set the PVID of the ports 5, 6 and 7 to 100. This tags untagged incoming frames on ports 5, 6 and 7 with the tag 100.

Figure 47 Tutorial: Tag Untagged Frames

Port	Ingress Check	PVID	GVRP	Acceptable Frame Type	VLAN Trunking	Isolation
*	<input type="checkbox"/>		<input type="checkbox"/>	All	<input type="checkbox"/>	<input type="checkbox"/>
1	<input type="checkbox"/>	1	<input type="checkbox"/>	All	<input type="checkbox"/>	<input type="checkbox"/>
2	<input type="checkbox"/>	1	<input type="checkbox"/>	All	<input type="checkbox"/>	<input type="checkbox"/>
3	<input type="checkbox"/>	1	<input type="checkbox"/>	All	<input type="checkbox"/>	<input type="checkbox"/>
4	<input type="checkbox"/>	1	<input type="checkbox"/>	All	<input type="checkbox"/>	<input type="checkbox"/>
5	<input type="checkbox"/>	100	<input type="checkbox"/>	All	<input type="checkbox"/>	<input type="checkbox"/>
6	<input type="checkbox"/>	100	<input type="checkbox"/>	All	<input type="checkbox"/>	<input type="checkbox"/>
7	<input type="checkbox"/>	100	<input type="checkbox"/>	All	<input type="checkbox"/>	<input type="checkbox"/>
8	<input type="checkbox"/>	1	<input type="checkbox"/>	All	<input type="checkbox"/>	<input type="checkbox"/>

- Go to **Advanced Application > IP Source Guard > IPv4 Source Guard Setup > DHCP Snooping > Configure**, activate and specify VLAN 100 as the DHCP VLAN as shown. Click **Apply**.

Figure 48 Tutorial: Specify DHCP VLAN

DHCP Snooping Configure [DHCP Snooping](#) [Port](#) [VLAN](#)

Active Disable

DHCP Vlan

Database

Agent URL

Timeout interval seconds

Write delay interval seconds

Renew DHCP Snooping URL [Renew](#)

[Apply](#) [Cancel](#)

- Click the **Port** link at the top right corner.
- The **DHCP Snooping Port Configure** screen appears. Select **Trusted** in the **Server Trusted state** field for port 5 because the DHCP server is connected to port 5. Keep ports 6 and 7 **Untrusted** because they are connected to DHCP clients. Click **Apply**.

Figure 49 Tutorial: Set the DHCP Server Port to Trusted

Port	Server Trusted state	Rate (pps)
*	Untrusted	
1	Untrusted	0
2	Untrusted	0
3	Untrusted	0
4	Untrusted	0
5	Trusted	0
6	Untrusted	0
7	Untrusted	0
8	Untrusted	0
9	Untrusted	0
10	Untrusted	0
11	Untrusted	0
12	Untrusted	0
13	Untrusted	0
14	Untrusted	0
15	Untrusted	0
16	Untrusted	0
17	Untrusted	0
18	Untrusted	0
19	Untrusted	0
20	Untrusted	0
21	Untrusted	0
22	Untrusted	0
23	Untrusted	0
24	Untrusted	0
25	Untrusted	0
26	Untrusted	0
27	Untrusted	0

- 7 Go to **Advanced Application > IP Source Guard > IPv4 Source Guard Setup > DHCP Snooping > Configure > VLAN**, show VLAN 100 by entering 100 in the **Start VID** and **End VID** fields and click **Apply**. Then select **Yes** in the **Enabled** field of the VLAN 100 entry shown at the bottom section of the screen.

If you want to add more information in the DHCP request packets such as source VLAN ID or system name, you can also select an **Option82 Profile** in the entry.

Figure 50 Tutorial: Enable DHCP Snooping on this VLAN

VID	Enabled	Option 82 Profile
*	No	
100	Yes	

- Click **Save** at the top right corner of the Web Configurator to save the configuration permanently.



- Connect your DHCP server to port 5 and a computer (as DHCP client) to either port 6 or 7. The computer should be able to get an IP address from the DHCP server. If you put the DHCP server on port 6 or 7, the computer will NOT be able to get an IP address.

- To check if DHCP snooping works, go to **Advanced Application > IP Source Guard > IPv4 Source Guard Setup**, you should see an IP assignment with the type **DHCP-Snooping** as shown.

Figure 51 Tutorial: Check the Binding If DHCP Snooping Works

IP Source Guard		IPSG Static Binding DHCP Snooping ARP Inspection				
Index	IP Address	VLAN	MAC Address	Port	Lease	Type
1	10.10.1.16	100	00:02:00:00:00:1c	6	6d23h17m 0s	dchp-snooping

You can also telnet. Use the command "show dhcp snooping binding" to see the DHCP snooping binding table as shown next.

```

sysname# show dhcp snooping binding
      MacAddress          IpAddress          Lease          Type          VLAN          Port
-----
00:02:00:00:00:1c      10.10.1.16      6d23h59m20s    dchp-snooping    100           6
Total number of bindings: 1
  
```

6.3 How to Use DHCPv4 Relay on the Switch

This tutorial describes how to configure your Switch to forward DHCP client requests to a specific DHCP server. The DHCP server can then assign a specific IP address based on the information in the DHCP requests.

6.3.1 DHCP Relay Tutorial Introduction

In this example, you have configured your DHCP server (192.168.2.3) and want to have it assign a specific IP address (say 172.16.1.18) to DHCP client **A** based on the system name, VLAN ID and port number in the DHCP request. Client **A** connects to the Switch's port 2 in VLAN 102.

Figure 52 Tutorial: DHCP Relay Scenario

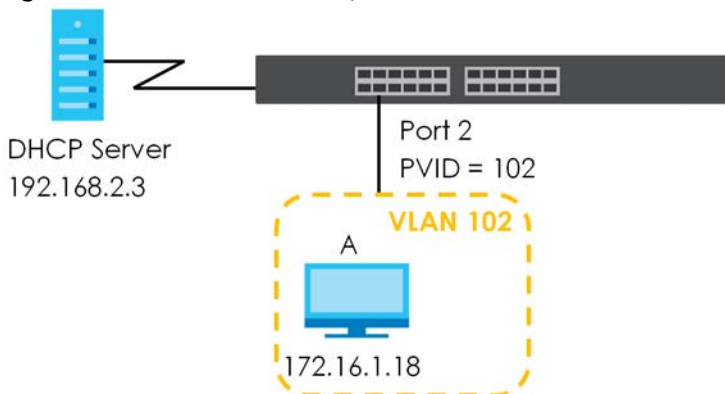

6.3.2 Create a VLAN

Follow the steps below to configure port 2 as a member of VLAN 102.

- 1 Access the Web Configurator through the Switch's management port.
- 2 Go to **Basic Setting > Switch Setup** and set the VLAN type to **802.1Q**. Click **Apply** to save the settings to the run-time memory.

Figure 53 Tutorial: Set VLAN Type to 802.1Q

Switch Setup			
VLAN Type	<input checked="" type="radio"/> 802.1Q	<input type="radio"/> Port Based	
MAC Address Learning	Aging Time	300	seconds
ARP Aging Time	Aging Time	300	seconds
GARP Timer	Join Timer	200	milliseconds
	Leave Timer	600	milliseconds
	Leave All Timer	10000	milliseconds
Priority Queue Assignment	Priority7	7	▼
	Priority6	6	▼
	Priority5	5	▼
	Priority4	4	▼
	Priority3	3	▼
	Priority2	1	▼
	Priority1	0	▼
	Priority0	2	▼
<input type="button" value="Apply"/> <input type="button" value="Cancel"/>			

- 3 Click **Advanced Application > VLAN > VLAN Configuration > Static VLAN Setup**.
- 4 In the **Static VLAN** screen, select **ACTIVE**, enter a descriptive name (VLAN 102 for example) in the **Name** field and enter 102 in the **VLAN Group ID** field.
- 5 Select **Fixed** to configure port 2 to be a permanent member of this VLAN.
- 6 Clear the **TX Tagging** check box to set the Switch to remove VLAN tags before sending.
- 7 Click **Add** to save the settings to the run-time memory. Settings in the run-time memory are lost when the Switch's power is turned off.

Figure 54 Tutorial: Create a Static VLAN

Static VLAN VLAN Configuration

ACTIVE

Name VLAN 102

VLAN Group ID 102

Port	Control	Tagging
1	Normal <input checked="" type="radio"/> Fixed <input type="radio"/> Forbidden <input type="radio"/>	<input checked="" type="checkbox"/> Tx Tagging
2	Normal <input type="radio"/> Fixed <input checked="" type="radio"/> Forbidden <input type="radio"/>	<input type="checkbox"/> Tx Tagging
3	Normal <input checked="" type="radio"/> Fixed <input type="radio"/> Forbidden <input type="radio"/>	<input checked="" type="checkbox"/> Tx Tagging
4	Normal <input checked="" type="radio"/> Fixed <input type="radio"/> Forbidden <input type="radio"/>	<input checked="" type="checkbox"/> Tx Tagging
5	Normal <input checked="" type="radio"/> Fixed <input type="radio"/> Forbidden <input type="radio"/>	<input checked="" type="checkbox"/> Tx Tagging
6	Normal <input checked="" type="radio"/> Fixed <input type="radio"/> Forbidden <input type="radio"/>	<input checked="" type="checkbox"/> Tx Tagging
7	Normal <input checked="" type="radio"/> Fixed <input type="radio"/> Forbidden <input type="radio"/>	<input checked="" type="checkbox"/> Tx Tagging
8	Normal <input checked="" type="radio"/> Fixed <input type="radio"/> Forbidden <input type="radio"/>	<input checked="" type="checkbox"/> Tx Tagging
9	Normal <input checked="" type="radio"/> Fixed <input type="radio"/> Forbidden <input type="radio"/>	<input checked="" type="checkbox"/> Tx Tagging

Add Cancel Clear

VID	Active	Name
1	Yes	1

Delete Cancel

- 8 Click the **VLAN Configuration** link in the **Static VLAN Setup** screen and then the **VLAN Port Setup** link in the **VLAN Configuration** screen.

Figure 55 Tutorial: Click the VLAN Port Setting Link

VLAN Configuration VLAN Status

Static VLAN Setup	Click Here
VLAN Port Setup	Click Here
Subnet Based VLAN Setup	Click Here
Protocol Based VLAN Setup	Click Here
Voice VLAN Setup	Click Here
MAC Based VLAN Setup	Click Here
Vendor ID Based VLAN Setup	Click Here

- 9 Enter 102 in the **PVID** field for port 2 to add a tag to incoming untagged frames received on that port so that the frames are forwarded to the VLAN group that the tag defines.
- 10 Click **Apply** to save your changes back to the run-time memory.

Figure 56 Tutorial: Add Tag for Frames Received on Port 2

Port	Ingress Check	PVID	GVRP	Acceptable Frame Type	VLAN Trunking	Isolation
*	<input type="checkbox"/>		<input type="checkbox"/>	All	<input type="checkbox"/>	<input type="checkbox"/>
1	<input type="checkbox"/>	1	<input type="checkbox"/>	All	<input type="checkbox"/>	<input type="checkbox"/>
2	<input type="checkbox"/>	102	<input type="checkbox"/>	All	<input type="checkbox"/>	<input type="checkbox"/>
3	<input type="checkbox"/>	1	<input type="checkbox"/>	All	<input type="checkbox"/>	<input type="checkbox"/>
4	<input type="checkbox"/>	1	<input type="checkbox"/>	All	<input type="checkbox"/>	<input type="checkbox"/>
5	<input type="checkbox"/>	100	<input type="checkbox"/>	All	<input type="checkbox"/>	<input type="checkbox"/>

- 11 Click the **Save** link in the upper right corner of the Web Configurator to save your configuration permanently.

6.3.3 Configure DHCPv4 Relay

Follow the steps below to enable DHCP relay on the Switch and allow the Switch to add relay agent information (such as the VLAN ID) to DHCP requests.

- 1 Click **IP Application > DHCP > DHCPv4** and then the **Global** link to open the **DHCP Relay** screen.
- 2 Select the **Active** check box.
- 3 Enter the DHCP server's IP address (192.168.2.3 in this example) in the **Remote DHCP Server 1** field.
- 4 Select **default1** or **default2** in the **Option 82 Profile** field.
- 5 Click **Apply** to save your changes back to the run-time memory.

Figure 57 Tutorial: Set DHCP Server and Relay Information

DHCP Relay		Status	Port
Active	<input checked="" type="checkbox"/>		
Remote DHCP Server 1	192.168.2.3		
Remote DHCP Server 2	0.0.0.0		
Remote DHCP Server 3	0.0.0.0		
Option 82 Profile	default1		

- 6 Click the **Save** link in the upper right corner of the Web Configurator to save your configuration permanently.
- 7 The DHCP server can then assign a specific IP address based on the DHCP request.

6.3.4 Troubleshooting

Check the client **A**'s IP address. If it did not receive the IP address 172.16.1.18, make sure:

- 1 Client **A** is connected to the Switch's port 2 in VLAN 102.
- 2 You configured the correct VLAN ID, port number and system name for DHCP relay on both the DHCP server and the Switch.
- 3 You clicked the **Save** link on the Switch to have your settings take effect.

CHAPTER 7

Status

7.1 Overview

This chapter describes the screens for System Status and Neighbor Details.

7.1.1 What You Can Do

- Use the **Status** screen ([Section 7.2 on page 75](#)) to see the Switch's general device information, system status, and IP addresses. You can also display other status screens for more information.
- Use the **Neighbor** screen ([Section 7.2.1 on page 77](#)) to view a summary and manage Switch's neighbor devices.
- Use the **Neighbor Detail** screen ([Section 7.2.2 on page 79](#)) to view more detailed information on the Switch's neighbor devices.

7.2 Status

The **Status** screen displays when you log into the Switch or click **Status** at the top right corner of the Web Configurator. The **Status** screen displays general device information, system status, and its IP addresses.

Figure 58 Status (for PoE models)

Status		Neighbor	
Device Information			
Device Type	GS1920-48HP	System Name	GS1920
Boot Version	V1.00 04/12/2018	System Location	
Firmware Version	V4.70(ABMK.0)b1 08/11/2020	System Time	01/01/2016 03:39:56
Hardware Version	V2.1	System Up Time	000 days,03 hours,40 mins,00 secs
MAC Address	bc:99:11:8d:a6:a5	Login Timeout(mins)	55
Serial Number	S182L20090023	Registration MAC Address	bc:99:11:8d:a6:a5
Hybrid Mode	Standalone QR Code	Cloud Control Status	Disconnected
PoE Usage	0.0/375.0 W (0%)		
Detail			
IP Address Information			
IPv4 Address	172.21.40.23		
Subnet Mask	255.255.252.0		
Default Gateway	172.21.43.254		IP Setup
IPv6 Global Unicast Address			
IPv6 Link-Local Address			IPv6 configuration
Device Status and Quick Configuration			
STP	Disable Setting	SNMP Status (!)	Enable Setting
Port Mirroring	Disable Setting	802.1X Status	Disable Setting
Storm Control	Disable Setting	DHCP Relay	Disable Setting
IGMP Snooping	Disable Setting	IPSG	Disable Setting
Quick Links			
Port Status	PoE Status	Link Aggregation Status	MAC Table
Diagnostic	System Log	Remote Access Control	Tech-support
VLAN Setup	Service Access Control		

The following table describes the labels in this screen.

Table 11 Status

LABEL	DESCRIPTION
Device Information	
Device Type	This field displays the model name of this Switch.
System Name	This field displays the name used to identify the Switch on any network.
Boot Version	This field displays the version number and date of the boot module that is currently on the Switch.
System Location	This field displays the geographic location of your Switch. You can change the setting in the Basic Setting > General Setup screen.
Firmware Version	This field displays the version number and date of the firmware the Switch is currently running.
System Time	This field displays the current date and time in the UAG. The format is mm-dd-yyyy hh:mm:ss.
Hardware Version	This field displays the hardware version number of the Switch. The integer is the generation number of the Switch series, and the decimal is the version of the hardware change. For example, V1.0 is a hardware version for the Switch where 1 identifies the first generation of the Switch series, and .0 is the first hardware change.
System Up Time	This field displays how long the Switch has been running since it last restarted or was turned on.
MAC Address	This field displays the MAC addresses of the Switch.
Login Timeout(mins)	This field displays how many minutes a management session can be left idle before the session times out. After it times out you have to log in with your password again.
Serial Number	This field displays the serial number of this Switch. The serial number is used for device tracking and control.
Registration MAC Address	This field displays the MAC address of the Switch that you must use to register at myZyxel.com or the NCC (Nebula Control Center).

Table 11 Status (continued)

LABEL	DESCRIPTION
Hybrid Mode	This field displays whether the Switch is in Standalone mode or Cloud mode. In Standalone mode you can see a link to a QR code to register the Switch to use NCC (Nebula Control Center).
Cloud Control Status	This field displays the registration and connection status between the Switch and the NCC (Nebula Control Center). In Standalone mode, the status will display Disconnected or Unregistered . In cloud mode the status will display Connected or Disconnected . Connected – The Switch is registered with and connected to the NCC. Disconnected – The Switch is not connected to the NCC. Unregistered – The Switch is not registered with the NCC.
Detail	Click this link to go to the Basic Setting > System Info screen to check other detailed information, such as system resource usage and the Switch temperature, fan speeds or voltage.
IP Address Information	
IPv4 Address	This field displays the Switch's current IPv4 address.
Subnet Mask	This field displays the Switch's subnet mask.
Default Gateway	This field displays the IP address of the Switch's default gateway.
IP Setup	Click the link to go to the Basic Setting > IP Setup screen.
IPv6 Global Unicast Address	This field displays the Switch's IPv6 global unicast address
IPv6 Link-Local Address	This field displays the Switch's IPv6 link-local address.
IPv6 configuration	Click the link to go to the Basic Setting > IPv6 screen.
Device Status and Quick Configuration	This section shows whether a feature is enabled or not on the Switch. You can click a feature's Setting link to go to the configuration screen for the feature. Hover your cursor over a red exclamation mark to display information about the feature.
Quick Links	This section provides the shortcut link to a specific configuration screen.

7.2.1 Neighbor Screen

The **Neighbor** screen allows you to view a summary and manage the Switch's neighboring devices. It uses Layer Link Discovery Protocol (LLDP) to discover all neighbor devices connected to the Switch including non-Zyxel devices. You can use this screen to perform tasks on the neighboring devices like login, power cycle (turn the power off and then back on again), and reset to factory default settings.

This screen shows the neighboring device first recognized on an Ethernet port of the Switch. Device information is displayed in gray when the neighboring device is offline.

Click **Status > Neighbor** to see the following screen.

Figure 59 Status > Neighbor

Switch Neighbor								Status Neighbor Detail	
Port	Port Name	Link	PoE Draw (W)	System Name	IPv4	IPv6	PWR Cycle	Reset to Default	<input type="checkbox"/>
1	--	Down	0.0	--	--	--	Cycle	Reset	<input type="checkbox"/>
2	--	Down	0.0	--	--	--	Cycle	Reset	<input type="checkbox"/>
3	--	Down	0.0	--	--	--	Cycle	Reset	<input type="checkbox"/>
4	--	Down	0.0	--	--	--	Cycle	Reset	<input type="checkbox"/>
5	--	Down	0.0	--	--	--	Cycle	Reset	<input type="checkbox"/>
6	--	Down	0.0	--	--	--	Cycle	Reset	<input type="checkbox"/>
7	--	Down	0.0	--	--	--	Cycle	Reset	<input type="checkbox"/>
8	--	Down	0.0	--	--	--	Cycle	Reset	<input type="checkbox"/>
9	--	Down	0.0	--	--	--	Cycle	Reset	<input type="checkbox"/>
10	--	Down	0.0	--	--	--	Cycle	Reset	<input type="checkbox"/>
...
48	--	Down	0.0	--	--	--	Cycle	Reset	<input type="checkbox"/>
49	--	Down	0.0	--	--	--	Cycle	Reset	<input type="checkbox"/>
50	--	Down	0.0	--	--	--	Cycle	Reset	<input type="checkbox"/>

[Flush](#)

The following table describes the fields in the above screen.

Table 12 Status > Neighbor

LABEL	DESCRIPTION
Port	This shows the port of the Switch, on which the neighboring device is discovered.
Port Name	This shows the port description of the Switch.
Link	This shows the speed (either 10M for 10Mbps, 100M for 100Mbps, or 1G for 1 Gbps) and the duplex (F for full duplex or H for half). This field displays Down if the port is not connected to any device.
PoE Draw (W)	This shows the consumption that the neighboring device connected to this port draws from the Switch. This allows you to plan and use within the power budget of the Switch.
System Name	This shows the system name of the neighbor device.
IPv4	This shows the IPv4 address of the neighbor device. The IPv4 address is a hyper link that you can click to log into and manage the neighbor device through its Web Configurator.
IPv6	This shows the IPv6 address of the neighbor device. The IPv6 address is a hyper link that you can click to log into and manage the neighbor device through its Web Configurator.
PWR Cycle	Click the Cycle button to turn OFF the power of the neighbor device and turn it back ON again. A count down button (from 5 to 0) starts. Note: The Switch must support power sourcing (PSE) or the network device is a powered device (PD).
Reset to Default	Click the Reset button to reset the neighboring device to its factory default settings. A warning message " Are you sure you want to load factory default? " appears prompting you to confirm the action. After confirming the action a count down button (from 5 to 0) starts. Note: <ul style="list-style-type: none"> The Switch must support power sourcing (PSE) or the network device is a powered device (PD). If multiple neighbor devices use the same port, the Reset button is not available. You can only reset Zyxel powered devices that support the ZON utility.
	Select an entry's check box to select a specific port. Otherwise, select the check box in the table heading row to select all ports.
Flush	Click the Flush button to remove information about neighbors learned on the selected ports.

7.2.2 Neighbor Detail

Use this screen to view detailed information about the neighboring devices. Device information is displayed in gray when the neighboring device is currently offline.

Up to 10 neighboring device records per Ethernet port can be retained in this screen even when the devices are offline. When the maximum number of neighboring device records per Ethernet port is reached, new device records automatically overwrite existing offline device records, starting with the oldest existing offline device record first.

Click the **Neighbor Detail** link in the **Status > Neighbor** screen to see the following screen.

Figure 60 Status > Neighbor > Neighbor Detail

The following table describes the fields in the above screen.

Table 13 Status > Neighbor > Neighbor Detail

LABEL	DESCRIPTION
Local Port	This shows the port of the Switch, on which the neighboring device is discovered.
Desc.	This shows the port description of the Switch.
Link	This shows the speed (either 10M for 10Mbps, 100M for 100Mbps, or 1G for 1 Gbps) and the duplex (F for full duplex or H for half). This field displays Down if the port is not connected to any device.
PoE Draw (W)	This shows the consumption that the neighboring device connected to this port draws from the Switch. This allows you to plan and use within the power budget of the Switch.
PWR Cycle	Click the Cycle button to turn OFF the power of the neighbor device and turn it back ON again. A count down button (from 5 to 0) starts. Note: The Switch must support power sourcing (PSE) or the network device is a powered device (PD).
Remote	

Table 13 Status > Neighbor > Neighbor Detail (continued)

LABEL	DESCRIPTION
System Name	This shows the system name of the neighbor device.
Model	This shows the model name of the neighbor device. This field will show "-" for devices that do not support the ZON utility.
Firmware	This shows the firmware version of the neighbor device. This field will show "-" for devices that do not support the ZON utility.
MAC	This shows the MAC address of the neighbor device.
IPv4	This shows the IPv4 address of the neighbor device. The IPv4 address is a hyper link that you can click to log into and manage the neighbor device through its Web Configurator.
IPv6	This shows the IPv6 address of the neighbor device. The IPv6 address is a hyper link that you can click to log into and manage the neighbor device through its Web Configurator.
Port	This show the number of the neighbor device's port which is connected to the Switch.
Desc.	This shows the description of the neighbor device's port which is connected to the Switch.
Location	This shows the geographic location of the neighbor device. This field will show "-" for devices that do not support the ZON utility.

CHAPTER 8

Basic Setting

8.1 Overview

This chapter describes how to configure the **System Info**, **General Setup**, **Switch Setup**, **IP Setup**, **Port Setup**, **PoE Setup**, **Interface Setup**, **IPv6**, and **Cloud Management** screens.

8.1.1 What You Can Do

- Use the **System Info** screen ([Section 8.2 on page 81](#)) to check the firmware version number and monitor the Switch temperature.
- Use the **General Setup** screen ([Section 8.3 on page 83](#)) to configure general settings such as the system name and time.
- Use the **Switch Setup** screen ([Section 8.5 on page 86](#)) to choose your VLAN type and assign priorities to queues.
- Use the **IP Setup** screen ([Section 8.6 on page 87](#)) to configure the Switch IP address, default gateway device, management VLAN ID, and proxy server.
- Use the **Port Setup** screen ([Section 8.7 on page 92](#)) to configure Switch port settings.
- Use the **PoE Setup** screens ([Section 8.8 on page 94](#)) to view the current amount of power that PDs are receiving from the Switch and set the priority levels for the Switch in distributing power to PDs. This screen is available for PoE models only.
- Use the **Interface Setup** screens ([Section 8.9 on page 100](#)) to configure Switch interface type and interface ID settings.
- Use the **IPv6** screens ([Section 8.10 on page 101](#)) to view IPv6 status and IPv6 configuration.
- Use the **Cloud Management** screen ([Section 8.11 on page 112](#)) to display links to **Nebula Control Center Discovery** and **Nebula Switch Registration** screens.

8.2 System Information

In the navigation panel, click **Basic Setting** > **System Info** to display the screen as shown. Use this screen to view general system information.

Figure 61 Basic Setting > System Info

System Info					
System Name	GS1920				
Product Model	GS1920-48HP				
ZyNOS F/W Version	V4.70[ABMK.0]b1 08/11/2020				
Ethernet Address	bc:99:11:8d:a6:a5				
CPU Utilization					
Current (%)	12.68				
Memory Utilization					
Name	Total (byte)	Used (byte)	Utilization (%)		
common	35381248	6132704	17		
Hardware Monitor					
Temperature Unit	C ▾				
Temperature (C)	Current	MAX	MIN	Threshold	Status
BOARD	50.0	51.0	30.0	98.0	Normal
MAC	52.0	53.0	28.0	82.0	Normal
PHY	47.0	48.0	29.0	88.0	Normal
FAN Speed (RPM)	Current	MAX	MIN	Threshold	Status
FAN1	3472	3481	3351	500	Normal
FAN2	3499	3517	3368	500	Normal
Voltage (V)	Current	MAX	MIN	Threshold	Status
1.1V	1.119	1.130	1.119	+6%/-6%	Normal
1.5V	1.516	1.516	1.516	+6%/-6%	Normal
3.3V	3.239	3.291	3.239	+6%/-6%	Normal
12V	12.031	12.093	12.031	+10%/-10%	Normal

The following table describes the labels in this screen.

Table 14 Basic Setting > System Info

LABEL	DESCRIPTION
System Name	This field displays the descriptive name of the Switch for identification purposes.
Product Model	This field displays the product model of the Switch. Use this information when searching for firmware upgrade or looking for other support information in the website.
ZyNOS F/W Version	This field displays the version number of the Switch 's current firmware including the date created.
Ethernet Address	This field refers to the Ethernet MAC (Media Access Control) address of the Switch.
CPU Utilization	CPU utilization quantifies how busy the system is. Current (%) displays the current percentage of CPU utilization.
Memory Utilization	Memory utilization shows how much DRAM memory is available and in use. It also displays the current percentage of memory utilization.
Name	This field displays the name of memory pool.
Total (byte)	This field displays the total number of bytes in this memory pool.
Used (byte)	This field displays the number of bytes being used in this memory pool.
Utilization (%)	This field displays the percentage (%) of memory being used in this memory pool.
Hardware Monitor	

Table 14 Basic Setting > System Info (continued)

LABEL	DESCRIPTION
Temperature Unit	The Switch has temperature sensors that are capable of detecting and reporting if the temperature rises above the threshold. You may choose the temperature unit (Centigrade or Fahrenheit) in this field.
Temperature (C/F)	BOARD / MAC and PHY/POWER refers to the location of the temperature sensor on the Switch printed circuit board.
Current	This shows the current temperature at this sensor.
MAX	This field displays the maximum temperature measured at this sensor.
MIN	This field displays the minimum temperature measured at this sensor.
Threshold	This field displays the upper temperature limit at this sensor.
Status	This field displays Normal for temperatures below the threshold and Error for those above.
FAN Speed (RPM)	A properly functioning fan is an essential component (along with a sufficiently ventilated, cool operating environment) in order for the device to stay within the temperature threshold. Each fan has a sensor that is capable of detecting and reporting if the fan speed falls below the threshold shown.
Current	This field displays this fan's current speed in Revolutions Per Minute (RPM).
MAX	This field displays this fan's maximum speed measured in Revolutions Per Minute (RPM).
MIN	This field displays this fan's minimum speed measured in Revolutions Per Minute (RPM). "<41" is displayed for speeds too small to measure (under 2000 RPM).
Threshold	This field displays the minimum speed at which a normal fan should work.
Status	Normal indicates that this fan is functioning above the minimum speed. Error indicates that this fan is functioning below the minimum speed.
Voltage(V)	The power supply for each voltage has a sensor that is capable of detecting and reporting if the voltage falls out of the tolerance range.
Current	This is the current voltage reading.
MAX	This field displays the maximum voltage measured at this point.
MIN	This field displays the minimum voltage measured at this point.
Threshold	This field displays the percentage tolerance of the voltage with which the Switch still works.
Status	Normal indicates that the voltage is within an acceptable operating range at this point; otherwise Error is displayed.

8.3 General Setup

Use this screen to configure general settings such as the system name and time. Click **Basic Setting > General Setup** in the navigation panel to display the screen as shown.

Figure 62 Basic Setting > General Setup

General Setup	
System Name	<input type="text"/>
Location	<input type="text"/>
Contact Person's Name	<input type="text"/>
Use Time Server when Bootup	NTP(RFC-1305) <input type="button" value="v"/>
Time Server IP Address	<input type="text" value="1.pool.ntp.org"/>
Time Server Sync Interval	1440 minutes
Current Time	11 : 00 : 46 UTC+00:00
New Time (hh:mm:ss)	11 : 00 : 46
Current Date	2016 - 01 - 01
New Date (yyyy-mm-dd)	2016 - 01 - 01
Time Zone	UTC <input type="button" value="v"/>
Daylight Saving Time	<input type="checkbox"/>
Start Date	First <input type="button" value="v"/> Sunday <input type="button" value="v"/> of January <input type="button" value="v"/> at 0:00 <input type="button" value="v"/>
End Date	First <input type="button" value="v"/> Sunday <input type="button" value="v"/> of January <input type="button" value="v"/> at 0:00 <input type="button" value="v"/>
<input type="button" value="Apply"/> <input type="button" value="Cancel"/>	

The following table describes the labels in this screen.

Table 15 Basic Setting > General Setup

LABEL	DESCRIPTION
System Name	Choose a descriptive name for identification purposes. This name consists of up to 64 printable characters; spaces are allowed.
Location	Enter the geographic location of your Switch. You can use up to 32 printable ASCII characters; spaces are allowed.
Contact Person's Name	Enter the name of the person in charge of this Switch. You can use up to 32 printable ASCII characters; spaces are allowed.
Use Time Server when Bootup	<p>Enter the time service protocol that your time server uses. Not all time servers support all protocols, so you may have to use trial and error to find a protocol that works. The main differences between them are the time format.</p> <p>When you select the Daytime (RFC 867) format, the Switch displays the day, month, year and time with no time zone adjustment. When you use this format it is recommended that you use a Daytime timeserver within your geographical time zone.</p> <p>Time (RFC-868) format displays a 4-byte integer giving the total number of seconds since 1970/1/1 at 0:0:0.</p> <p>NTP (RFC-1305) is similar to Time (RFC-868).</p> <p>None is the default value. Enter the time manually. Each time you turn on the Switch, the time and date will be reset to 1970-1-1 0:0:0.</p>
Time Server IP Address	Enter the IP address or domain name of your timeserver. The Switch searches for the timeserver for up to 60 seconds.
Time Server Sync Interval	Enter the period in minutes between each time server synchronization. The Switch checks the time server after every synchronization interval.
Current Time	This field displays the time you open this menu (or refresh the menu).
New Time (hh:min:ss)	Enter the new time in hour, minute and second format. The new time then appears in the Current Time field after you click Apply .
Current Date	This field displays the date you open this menu.

Table 15 Basic Setting > General Setup (continued)

LABEL	DESCRIPTION
New Date (yyyy-mm-dd)	Enter the new date in year, month and day format. The new date then appears in the Current Date field after you click Apply .
Time Zone	Select the time difference between UTC (Universal Time Coordinated, formerly known as GMT, Greenwich Mean Time) and your time zone from the drop-down list box.
Daylight Saving Time	Daylight saving is a period from late spring to early fall when many countries set their clocks ahead of normal local time by one hour to give more daytime light in the evening. Select this option if you use Daylight Saving Time.
Start Date	Configure the day and time when Daylight Saving Time starts if you selected Daylight Saving Time . The time is displayed in the 24 hour format. Here are a couple of examples: Daylight Saving Time starts in most parts of the United States on the second Sunday of March. Each time zone in the United States starts using Daylight Saving Time at 2 A.M. local time. So in the United States you would select Second, Sunday, March and 2:00 . Daylight Saving Time starts in the European Union on the last Sunday of March. All of the time zones in the European Union start using Daylight Saving Time at the same moment (1 A.M. GMT or UTC). So in the European Union you would select Last, Sunday, March and the last field depends on your time zone. In Germany for instance, you would select 2:00 because Germany's time zone is one hour ahead of GMT or UTC (GMT+1).
End Date	Configure the day and time when Daylight Saving Time ends if you selected Daylight Saving Time . The time field uses the 24 hour format. Here are a couple of examples: Daylight Saving Time ends in the United States on the first Sunday of November. Each time zone in the United States stops using Daylight Saving Time at 2 A.M. local time. So in the United States you would select First, Sunday, November and 2:00 . Daylight Saving Time ends in the European Union on the last Sunday of October. All of the time zones in the European Union stop using Daylight Saving Time at the same moment (1 A.M. GMT or UTC). So in the European Union you would select Last, Sunday, October and the last field depends on your time zone. In Germany for instance, you would select 2:00 because Germany's time zone is one hour ahead of GMT or UTC (GMT+1).
Apply	Click Apply to save your changes to the Switch's run-time memory. The Switch loses these changes if it is turned off or loses power, so use the Save link on the top navigation panel to save your changes to the non-volatile memory when you are done configuring.
Cancel	Click Cancel to begin configuring this screen afresh.

8.4 Introduction to VLANs

A VLAN (Virtual Local Area Network) allows a physical network to be partitioned into multiple logical networks. Devices on a logical network belong to one group. A device can belong to more than one group. With VLAN, a device cannot directly talk to or hear from devices that are not in the same groups; the traffic must first go through a router.

In MTU (Multi-Tenant Unit) applications, VLAN is vital in providing isolation and security among the subscribers. When properly configured, VLAN prevents one subscriber from accessing the network resources of another on the same LAN, thus a user will NOT see the printers and hard disks of another user in the same building.

VLAN also increases network performance by limiting broadcasts to a smaller and more manageable logical broadcast domain. In traditional switched environments, all broadcast packets go to each and every individual port. With VLAN, all broadcasts are confined to a specific broadcast domain.

Note: VLAN is unidirectional; it only governs outgoing traffic.

8.5 Switch Setup

Click **Basic Setting** > **Switch Setup** in the navigation panel to display the screen as shown. The VLAN setup screens change depending on whether you choose **802.1Q** or **Port Based** in the **VLAN Type** field in this screen.

Figure 63 Basic Setting > Switch Setup

Switch Setup			
VLAN Type	<input checked="" type="radio"/> 802.1Q <input type="radio"/> Port Based		
MAC Address Learning	Aging Time	300	seconds
ARP Aging Time	Aging Time	300	seconds
GARP Timer	Join Timer	200	milliseconds
	Leave Timer	600	milliseconds
	Leave All Timer	10000	milliseconds
Priority Queue Assignment	Priority7	7	▼
	Priority6	6	▼
	Priority5	5	▼
	Priority4	4	▼
	Priority3	3	▼
	Priority2	1	▼
	Priority1	0	▼
	Priority0	2	▼
<input type="button" value="Apply"/> <input type="button" value="Cancel"/>			

The following table describes the labels in this screen.

Table 16 Basic Setting > Switch Setup

LABEL	DESCRIPTION
VLAN Type	Choose 802.1Q or Port Based . The VLAN Setup screen changes depending on whether you choose 802.1Q VLAN type or Port Based VLAN type in this screen.
MAC Address Learning	
MAC address learning reduces outgoing traffic broadcasts. For MAC address learning to occur on a port, the port must be active.	
Aging Time	Enter a time from 10 to 1000000 seconds. This is how long all dynamically learned MAC addresses remain in the MAC address table before they age out (and must be relearned).
ARP Aging Time	
Aging Time	Enter a time from 60 to 1000000 seconds. This is how long dynamically learned ARP entries remain in the ARP table before they age out (and must be relearned). The setting here applies to ARP entries which are newly added in the ARP table after you click Apply .
GARP Timer: Switches join VLANs by making a declaration. A declaration is made by issuing a Join message using GARP. Declarations are withdrawn by issuing a Leave message. A Leave All message terminates all registrations. GARP timers set declaration timeout values. See the chapter on VLAN setup for more background information.	
Join Timer	Join Timer sets the duration of the Join Period timer for GVRP in milliseconds. Each port has a Join Period timer. The allowed Join Time range is between 100 and 65535 milliseconds; the default is 200 milliseconds. See the chapter on VLAN setup for more background information.
Leave Timer	Leave Time sets the duration of the Leave Period timer for GVRP in milliseconds. Each port has a single Leave Period timer. Leave Time must be two times larger than Join Timer ; the default is 600 milliseconds.

Table 16 Basic Setting > Switch Setup (continued)

LABEL	DESCRIPTION
Leave All Timer	Leave All Timer sets the duration of the Leave All Period timer for GVRP in milliseconds. Each port has a single Leave All Period timer. Leave All Timer must be larger than Leave Timer.
Priority Queue Assignment	
IEEE 802.1p defines up to eight separate traffic types by inserting a tag into a MAC-layer frame that contains bits to define class of service. Frames without an explicit priority tag are given the default priority of the ingress port. Use the next fields to configure the priority level-to-physical queue mapping.	
The Switch has eight physical queues that you can map to the eight priority levels. On the Switch, traffic assigned to higher index queues gets through faster while traffic in lower index queues is dropped if the network is congested.	
Priority Level (The following descriptions are based on the traffic types defined in the IEEE 802.1d standard (which incorporates the 802.1p).	
To map a priority level to a physical queue, select a physical queue from the drop-down menu on the right.	
Priority 7	Typically used for network control traffic such as router configuration messages.
Priority 6	Typically used for voice traffic that is especially sensitive to jitter (jitter is the variations in delay).
Priority 5	Typically used for video that consumes high bandwidth and is sensitive to jitter.
Priority 4	Typically used for controlled load, latency-sensitive traffic such as SNA (Systems Network Architecture) transactions.
Priority 3	Typically used for "excellent effort" or better than best effort and would include important business traffic that can tolerate some delay.
Priority 2	This is for "spare bandwidth".
Priority 1	This is typically used for non-critical "background" traffic such as bulk transfers that are allowed but that should not affect other applications and users.
Priority 0	Typically used for best-effort traffic.
Apply	Click Apply to save your changes to the Switch's run-time memory. The Switch loses these changes if it is turned off or loses power, so use the Save link on the top navigation panel to save your changes to the non-volatile memory when you are done configuring.
Cancel	Click Cancel to begin configuring this screen afresh.

8.6 IP Setup

Use the **IP Setup** screen to configure the default gateway device, the default domain name server and add IP domains.

You can configure up to 64 IP domains which are used to access and manage the Switch from the ports belonging to the pre-defined VLANs.

Note: You must configure a VLAN first. Each VLAN can only have one management IP address.

8.6.1 IP Status

Figure 64 Basic Setting > IP Status

IP Status		IP Configuration
Domain Name Server	172.21.10.1	Source
		DHCPv4

IP Interface					
Index	IP Address	IP Subnet Mask	VID	Type	Action
1	172.21.40.3	255.255.252.0	1	DHCP	<input type="button" value="Renew"/> <input type="button" value="Release"/>

The following table describes the labels in this screen.

Table 17 Basic Setting > IP Status

LABEL	DESCRIPTION
IP Status	
Domain Name Server	This field displays the IP address of the DNS server.
Source	This field displays whether the DNS server address is configured manually (Static) or obtained automatically using DHCPv4 .
IP Interface	
Index	This field displays the index number of an entry.
IP Address	This field displays IP address of the Switch in the IP domain.
IP Subnet Mask	This field displays the subnet mask of the Switch in the IP domain.
VID	This field displays the VLAN identification number of the IP domain on the Switch.
Type	This shows whether this IP address is dynamically assigned from a DHCP server or manually assigned (Static).
Renew	Click this to renew the dynamic IP address.
Release	Click this to release the dynamic IP address.

8.6.2 IP Status Details

Use this screen to view IP status details. Click a number in the **Index** column in the **IP Status** screen to display the screen as shown next.

Figure 65 Basic Setting > IP Setup > IP Status Details: Static

IP Status Detail		IP Status
Type	Static	
VID	1	
IP Address	172.21.40.3	
IP Subnet Mask	255.255.252.0	

The following table describes the labels in this screen.

Table 18 Basic Setting > IP Setup > IP Status Details: Static

LABEL	DESCRIPTION
Type	This shows the IP address is manually assigned (Static).
VID	This is the VLAN identification number to which an IP routing domain belongs.
IP Address	This is the IP address of your Switch in dotted decimal notation for example 192.168.1.1.
IP Subnet Mask	This is the IP subnet mask of your Switch in dotted decimal notation for example 255.255.255.0.

Figure 66 Basic Setting > IP Setup > IP Status Details: DHCP

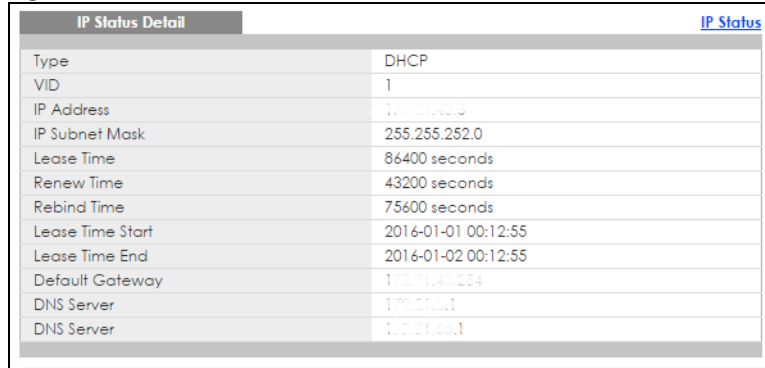

IP Status Detail		IP Status
Type	DHCP	
VID	1	
IP Address	192.168.1.1	
IP Subnet Mask	255.255.252.0	
Lease Time	86400 seconds	
Renew Time	43200 seconds	
Rebind Time	75600 seconds	
Lease Time Start	2016-01-01 00:12:55	
Lease Time End	2016-01-02 00:12:55	
Default Gateway	192.168.254	
DNS Server	192.168.1	
DNS Server	192.168.1	

The following table describes the labels in this screen.

Table 19 Basic Setting > IP Setup > IP Status Details: DHCP

LABEL	DESCRIPTION
Type	This shows the IP address is dynamically assigned from a DHCP server (DHCP).
VID	This is the VLAN identification number to which an IP routing domain belongs.
IP Address	This is the IP address of your Switch in dotted decimal notation for example 192.168.1.1.
IP Subnet Mask	This is the IP subnet mask of your Switch in dotted decimal notation for example 255.255.255.0.
Lease Time	This displays the length of time in seconds that this interface can use the current dynamic IP address from the DHCP server.
Renew Time	This displays the length of time from the lease start that the Switch will request to renew its current dynamic IP address from the DHCP server.
Rebind Time	This displays the length of time from the lease start that the Switch will request to get any dynamic IP address from the DHCP server.
Lease Time Start	This displays the date and time that the current dynamic IP address assignment from the DHCP server began. You should configure date and time in Basic Setting > General Setup .
Lease Time End	This displays the date and time that the current dynamic IP address assignment from the DHCP server will end. You should configure date and time in Basic Setting > General Setup .
Default Gateway	This displays the IP address of the default gateway assigned by the DHCP server. 0.0.0.0 means no gateway is assigned.
DNS Server	This displays the IP address of the primary and secondary DNS servers assigned by the DHCP server. 0.0.0.0 means no DNS server is assigned.

8.6.3 IP Configuration

Use this screen to configure the default gateway device, the default domain name server and add IP domains.

Figure 67 Basic Setting > IP Setup > IP Configuration

The following table describes the labels in this screen.

Table 20 Basic Setting > IP Setup > IP Configuration

LABEL	DESCRIPTION
Domain Name Server 1/2	Enter a domain name server IPv4 address in order to be able to use a domain name instead of an IP address.
Default Management IP Address	Use these fields to create or edit IP routing domains on the Switch.
DHCP Client	Select this option if you have a DHCP server that can assign the Switch an IP address, subnet mask, a default gateway IP address and a domain name server IP address automatically.
Static IP Address	Select this option if you do not have a DHCP server or if you wish to assign static IP address information to the Switch. You need to fill in the following fields when you select this option.
IP Address	Enter the IP address of your Switch in dotted decimal notation, for example, 172.21.40.x. This is the IP address of the Switch in an IP routing domain.
IP Subnet Mask	Enter the IP subnet mask of an IP routing domain in dotted decimal notation, for example, 255.255.252.0.
Default Gateway	Type the IP address of the default outgoing gateway in dotted decimal notation, for example 172.21.43.254.
VID	Enter the VLAN identification number associated with the Switch IP address. This is the VLAN ID of the CPU and is used for management only. The default is "1". All ports, by default, are fixed members of this "Management VLAN" in order to manage the device from any port. If a port is not a member of this VLAN, then users on that port cannot access the device. To access the Switch make sure the port that you are connected to is a member of Management VLAN.

Table 20 Basic Setting > IP Setup > IP Configuration (continued)

LABEL	DESCRIPTION
Apply	Click Apply to save your changes to the Switch's run-time memory. The Switch loses these changes if it is turned off or loses power, so use the Save link on the top navigation panel to save your changes to the non-volatile memory when you are done configuring.
Cancel	Click Cancel to reset the fields to your previous configuration.
Management IP Address	
Use these fields to set the settings for the management port.	
IP Address	Enter the IP address for managing the Switch by the members of the VLAN specified in the VID field below.
IP Subnet Mask	Enter the IP subnet mask of your Switch in dotted decimal notation, for example, 255.255.255.0.
VID	Enter the VLAN identification number to which an IP routing domain belongs.
Default Gateway	Enter the IP address of the default outgoing gateway in dotted decimal notation, for example, 192.168.0.254.
Add	Click this to create a new entry. This saves your changes to the Switch's run-time memory. The Switch loses these changes if it is turned off or loses power, so use the Save link on the top navigation panel to save your changes to the non-volatile memory when you are done configuring.
Cancel	Click Cancel to reset the fields to your previous configuration.
Index	This field displays the index number of an entry.
IP Address	This field displays IP address of the Switch in the IP domain.
IP Subnet Mask	This field displays the subnet mask of the Switch in the IP domain.
VID	This field displays the VLAN identification number of the IP domain on the Switch.
Default Gateway	This field displays the IP address of the default outgoing gateway in dotted decimal notation.
	Select an entry's check box to select a specific entry. Otherwise, select the check box in the table heading row to select all entries.
Delete	Click Delete to remove the selected entry from the summary table. Note: Deleting all IP subnets locks you out of the Switch.
Cancel	Click Cancel to clear the check boxes.

8.6.4 Network Proxy Configuration

The proxy server of an organization may prohibit communication between the Switch and NCC (Nebula Control Center) ([Section 8.11 on page 112](#)). Use this screen to enable communication between the Switch and NCC through the proxy server.

Figure 68 Network Proxy Configuration Application

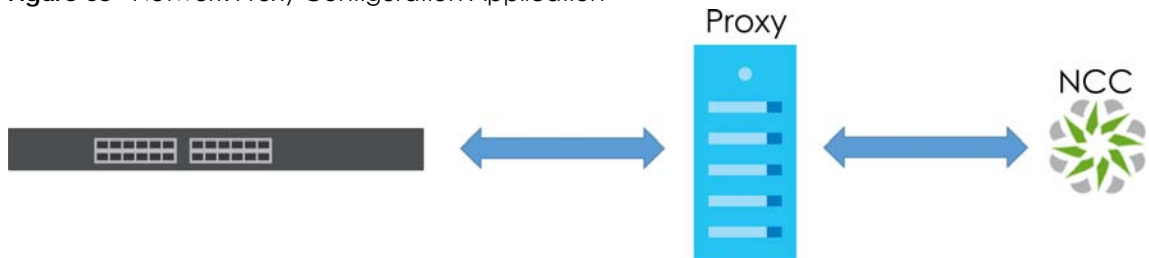

As of this writing, this setting only allows communication between the Switch and the NCC.

Figure 69 Basic Setting > IP Setup > IP Configuration > Network Proxy Configuration

The following table describes the labels in this screen.

Table 21 Basic Setting > IP Setup > IP Configuration > Network Proxy Configuration

LABEL	DESCRIPTION
Active	Select this option to enable communication between the Switch and NCC through a proxy server.
Server	Enter the IP address (dotted decimal notation) or host name of the proxy server. When entering the host name, up to 128 alphanumeric characters are allowed for the Server including special characters inside the square quotes [~!@#\$\$%^&*()_+{} :"<>?-=[]\;'./']
Port	Enter the port number of the proxy server (1 – 65535).
Authentication	Select this option to enable proxy server authentication using a Username and Password .
Username	Enter a login user name from the proxy server administrator. Up to 32 alphanumeric characters are allowed for the Username including special characters inside the square quotes [~!@#\$\$%^&*()_+{} :"<>?-=[]\;'./'].
Password	Enter a login password from the proxy server administrator. Up to 32 alphanumeric characters are allowed for the Password including special characters inside the square quotes [~!@#\$\$%^&*()_+{} :"<>?-=[]\;'./'].
Apply	Click Apply to save your changes to the Switch's run-time memory. The Switch loses these changes if it is turned off or loses power, so use the Save link on the top navigation panel to save your changes to the non-volatile memory when you are done configuring.
Cancel	Click Cancel to reset the fields to your previous configuration.

8.7 Port Setup

Use this screen to configure Switch port settings. Click **Basic Setting** > **Port Setup** in the navigation panel to display the configuration screen.

Figure 70 Basic Setting > Port Setup

Port	Active	Name	Speed / Duplex	Flow Control	802.1p Priority
*	<input type="checkbox"/>		Auto	<input type="checkbox"/>	0
1	<input checked="" type="checkbox"/>		Auto	<input type="checkbox"/>	0
2	<input checked="" type="checkbox"/>		Auto	<input type="checkbox"/>	0
3	<input checked="" type="checkbox"/>		Auto	<input type="checkbox"/>	0
4	<input checked="" type="checkbox"/>		Auto	<input type="checkbox"/>	0
5	<input checked="" type="checkbox"/>		Auto	<input type="checkbox"/>	0
6	<input checked="" type="checkbox"/>		Auto	<input type="checkbox"/>	0
7	<input checked="" type="checkbox"/>		Auto	<input type="checkbox"/>	0
8	<input checked="" type="checkbox"/>		Auto	<input type="checkbox"/>	0
9	<input checked="" type="checkbox"/>		Auto	<input type="checkbox"/>	0

Apply Cancel

The following table describes the labels in this screen.

Table 22 Basic Setting > Port Setup

LABEL	DESCRIPTION
Port	This is the port index number.
*	Settings in this row apply to all ports. Use this row only if you want to make some settings the same for all ports. Use this row first to set the common settings and then make adjustments on a port-by-port basis. Note: Changes in this row are copied to all the ports as soon as you make them.
Active	Select this check box to enable a port. The factory default for all ports is enabled. A port must be enabled for data transmission to occur.
Name	Enter a descriptive name that identifies this port. You can enter up to 64 alpha-numerical characters. Note: Due to space limitation, the port name may be truncated in some Web Configurator screens.
Speed/Duplex	Select the speed and the duplex mode of the Ethernet connection on this port. Choices are Auto , 10-an (10M/auto-negotiation), 10M/Half Duplex , 10M/Full Duplex , 100-an (100M/auto-negotiation), 100M/Half Duplex , 100M/Full Duplex and 1G/Full Duplex (Gigabit connections only). Selecting Auto (auto-negotiation) allows one port to negotiate with a peer port automatically to obtain the connection speed and duplex mode that both ends support. When auto-negotiation is turned on, a port on the Switch negotiates with the peer automatically to determine the connection speed and duplex mode. If the peer port does not support auto-negotiation or turns off this feature, the Switch determines the connection speed by detecting the signal on the cable and using half duplex mode. When the Switch's auto-negotiation is turned off, a port uses the pre-configured speed and duplex mode when making a connection, thus requiring you to make sure that the settings of the peer port are the same in order to connect.

Table 22 Basic Setting > Port Setup (continued)

LABEL	DESCRIPTION
Flow Control	<p>A concentration of traffic on a port decreases port bandwidth and overflows buffer memory causing packet discards and frame losses. Flow Control is used to regulate transmission of signals to match the bandwidth of the receiving port.</p> <p>The Switch uses IEEE802.3x flow control in full duplex mode and backpressure flow control in half duplex mode.</p> <p>IEEE802.3x flow control is used in full duplex mode to send a pause signal to the sending port, causing it to temporarily stop sending signals when the receiving port memory buffers fill.</p> <p>Back Pressure flow control is typically used in half duplex mode to send a "collision" signal to the sending port (mimicking a state of packet collision) causing the sending port to temporarily stop sending signals and resend later. Select Flow Control to enable it.</p>
802.1p Priority	This priority value is added to incoming frames without a (802.1p) priority queue tag. See Priority Queue Assignment in Table 16 on page 86 for more information.
Apply	Click Apply to save your changes to the Switch's run-time memory. The Switch loses these changes if it is turned off or loses power, so use the Save link on the top navigation panel to save your changes to the non-volatile memory when you are done configuring.
Cancel	Click Cancel to begin configuring this screen afresh.

8.8 PoE Status

Note: The following screens are available for the PoE models only. Some features are only available for the Ethernet ports (1 to 8 for GS1920-8HPv2, 1 to 24 for GS1920-24HPv2, and 1 to 48 for GS1920-48HPv2).

The PoE models supports the IEEE 802.3at High Power over Ethernet (PoE) standard.

A powered device (PD) is a device such as an access point or a switch, that supports PoE (Power over Ethernet) so that it can receive power from another device through an Ethernet port.

In the figure below, the IP camera and IP phone get their power directly from the Switch. Aside from minimizing the need for cables and wires, PoE removes the hassle of trying to find a nearby electric outlet to power up devices.

Figure 71 Powered Device Examples

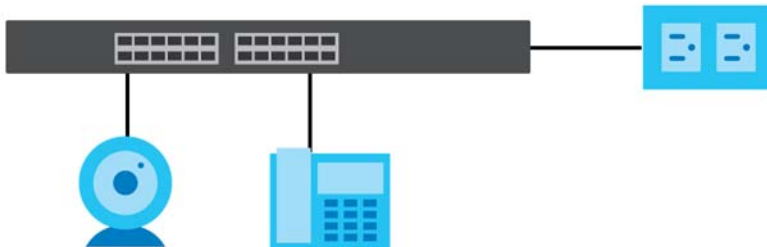

You can also set priorities so that the Switch is able to reserve and allocate power to certain PDs.

Note: The PoE (Power over Ethernet) devices that supply or receive power and their connected Ethernet cables must all be completely indoors.

PoE-Disabled Mechanism for GS1920-8HPv2

The GS1920-8HPv2 is a compact and fanless Switch capable of supplying Power over Ethernet (PoE). Certain action will be taken when the temperature of the GS1920-8HPv2 reaches the temperature thresholds. Please see the table below for how the mechanism works.

Table 23 Temperature and Action

TEMPERATURE	ACTION
74°C/165.2.°F	When the temperature of the GS1920-8HPv2 reaches this temperature threshold, the SYS LED will become steady red. To cool down the GS1920-8HPv2, make sure there is enough clearance for ventilation. You can also relocate the GS1920-8HPv2 to a cooler place.
79°C/174.2.°F	If the temperature keeps climbing and reaches this temperature threshold, PoE will be turned off automatically.
Below 74°C/165.2.°F	PoE will be turned on again when the temperature drops and remains below this temperature threshold for a 30-minute period.

Note: The GS1920-8HPv2 will generate logs messages for the situations listed in the **System Log** screen. They will also be sent to the syslog server.

To view the current amount of power that PDs are receiving from the Switch, click **Basic Setting > PoE Setup**.

Figure 72 Basic Setting > PoE Status

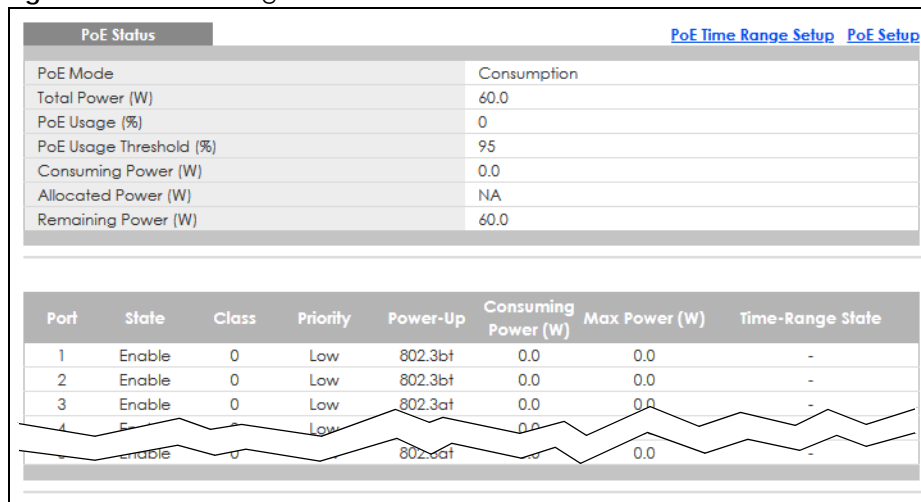

The following table describes the labels in this screen.

Table 24 Basic Setting > PoE Status

LABEL	DESCRIPTION
PoE Mode	This field displays the power management mode used by the Switch, whether it is in Classification or Consumption mode.
Total Power (W)	This field displays the total power the Switch can provide to the connected PoE-enabled devices on the PoE ports.
PoE Usage (%)	This field displays the amount of power currently being supplied to connected PoE devices (PDs) as a percentage of the total PoE power the Switch can supply. When PoE usage reaches 100%, the Switch will shut down PDs one-by-one according to the PD priority which you configured in Basic Setting > PoE Setup .

Table 24 Basic Setting > PoE Status (continued)

LABEL	DESCRIPTION
PoE Usage Threshold (%)	This field displays the percentage of PoE usage. The Switch will generate a trap and/or a log when the usage exceeds the specified threshold.
Consuming Power (W)	This field displays the amount of power the Switch is currently supplying to the connected PoE-enabled devices.
Allocated Power (W)	This field displays the total amount of power the Switch (in classification mode) has reserved for PoE after negotiating with the connected PoE devices. It shows NA when the Switch is in consumption mode. Consuming Power (W) can be less than or equal but not more than the Allocated Power (W) .
Remaining Power (W)	This field displays the amount of power the Switch can still provide for PoE. Note: The Switch must have at least 16 W of remaining power in order to supply power to a PoE device, even if the PoE device needs less than 16 W.
Port	This is the port index number.
State	This field shows which ports can receive power from the Switch. You can set this in Section 8.8.2 on page 97 . <ul style="list-style-type: none"> • Disable – The PD connected to this port cannot get power supply. • Enable – The PD connected to this port can receive power.
Class	This shows the power classification of the PD. Each PD has a specified maximum power that fall under one of the classes. The Class is a number from 0 to 4, where each value represents the range of power that the Switch provides to the PD. Each class corresponds to a default maximum power that can be extended in Basic Setting > PoE Setup > PoE Setup to the following values. <ul style="list-style-type: none"> • Class 0 – default: 0.44 W to 15.4 W, can be extended to 17.8 W. • Class 1 – default: 0.44 W to 4 W, can be extended to 5.8 W. • Class 2 – default: 0.44 W to 7 W, can be extended to 9 W. • Class 3 – default: 0.44 W to 15.4 W, can be extended to 17.8 W. • Class 4 – default: 0.44 W to 30 W, can be extended to 32.8 W.
Priority	When the total power requested by the PDs exceeds the total PoE power budget on the Switch, you can set the priority to allow the Switch to provide power to ports with higher priority first. <ul style="list-style-type: none"> • Critical has the highest priority. • High has the Switch assign power to the port after all critical priority ports are served. • Low has the Switch assign power to the port after all critical and high priority ports are served.
Power-Up	This field displays the PoE standard the Switch uses to provide power on this port.
Consuming Power (W)	This field displays the current amount of power consumed by the PD from the Switch on this port.
Max Power (W)	This field displays the maximum amount of power the PD could use from the Switch on this port.
Time-Range State	This field shows whether or not the port currently receives power from the Switch according to its schedule. <ul style="list-style-type: none"> • It shows "In" followed by the time range name if PoE is currently enabled on the port. • It shows "Out" if PoE is currently disabled on the port. • It shows "–" if no schedule is applied to the port. PoE is enabled by default.

8.8.1 PoE Time Range Setup

Use this screen to apply a schedule to the ports on the Switch. You must first configure a schedule in the **Advanced Application > Time Range** screen.

Click the **PoE Time Range Setup** link in the **Basic Setting > PoE Status** screen. The following screen opens.

Figure 73 Basic Setting > PoE Setup > PoE Time Range Setup

The screenshot shows the 'PoE Time Range Setup' interface. At the top, there's a title bar with 'PoE Time Range Setup' on the left and 'PoE Status' on the right. Below the title bar, there are two main input areas: 'Port' and 'Time Range'. The 'Port' field is empty, and the 'Time Range' field is a dropdown menu. Below these fields are two buttons: 'Apply' and 'Clear'. Underneath is a table with the following structure:

Port	Time Range Profiles	
1	-	<input type="checkbox"/>
2	-	<input type="checkbox"/>
3	-	<input type="checkbox"/>
4	-	<input type="checkbox"/>
5	-	<input type="checkbox"/>
6	-	<input type="checkbox"/>
7	-	<input type="checkbox"/>

At the bottom of the screen, there are two buttons: 'Delete' and 'Cancel'.

The following table describes the labels in this screen.

Table 25 Basic Setting > PoE Setup > PoE Time Range Setup

LABEL	DESCRIPTION
Port	Enter the number of the port to which you want to apply a schedule.
Time Range	This field displays the name of the schedule that you have created using the Advanced Application > Time Range screen. Select a pre-defined schedule to control when the Switch enables PoE to provide power on the port. To select more than one schedule, press [SHIFT] and select the choices at the same time.
Apply	Click Apply to save your changes to the Switch's run-time memory. The Switch loses these changes if it is turned off or loses power, so use the Save link on the top navigation panel to save your changes to the non-volatile memory when you are done configuring.
Clear	Click Clear to clear the fields to the factory defaults.
Port	This field displays the index number of the port. Click a port number to change the schedule settings.
Time Range Profiles	This field displays the name of the schedule which is applied to the port. PoE is enabled at the specified time or date.
	Select an entry's check box to select a specific entry. Otherwise, select the check box in the table heading row to select all entries.
Delete	Check the rules that you want to remove and then click the Delete button.
Cancel	Click Cancel to clear the selected check boxes.

8.8.2 PoE Setup

Use this screen to set the PoE power management mode, priority levels, power-up mode and the maximum amount of power for the connected PDs.

Click the **PoE Setup** link in the **Basic Setting > PoE Status** screen. The following screen opens.

Figure 74 Basic Setting > PoE Setup

PoE Setup		PoE Status
PoE Mode	<input type="radio"/> Classification <input checked="" type="radio"/> Consumption	
Pre-Allocate	Active	<input checked="" type="checkbox"/>
Dual Detection	Active	<input type="checkbox"/>
Power Up Sequence Delay	Active	<input checked="" type="checkbox"/>
PoE Usage Threshold (%)	95	

Port	Active	Priority	Power-Up	Max Power (mW)	Wide Range Detection	LLDP Power Via MDI
*	<input type="checkbox"/>	Critical	802.3af		<input type="checkbox"/>	<input type="checkbox"/>
1	<input checked="" type="checkbox"/>	Low	802.3at		<input type="checkbox"/>	<input checked="" type="checkbox"/>
2	<input checked="" type="checkbox"/>	Low	802.3at		<input type="checkbox"/>	<input checked="" type="checkbox"/>
3	<input checked="" type="checkbox"/>	Low	802.3at		<input type="checkbox"/>	<input checked="" type="checkbox"/>
4	<input checked="" type="checkbox"/>	Low	802.3at		<input type="checkbox"/>	<input checked="" type="checkbox"/>
5	<input checked="" type="checkbox"/>	Low	802.3at		<input type="checkbox"/>	<input checked="" type="checkbox"/>
6	<input checked="" type="checkbox"/>	Low	802.3at		<input type="checkbox"/>	<input checked="" type="checkbox"/>
7	<input checked="" type="checkbox"/>	Low	802.3at		<input type="checkbox"/>	<input checked="" type="checkbox"/>
8	<input checked="" type="checkbox"/>	Low	802.3at		<input type="checkbox"/>	<input checked="" type="checkbox"/>
9	<input checked="" type="checkbox"/>	Low	802.3at		<input type="checkbox"/>	<input checked="" type="checkbox"/>
10	<input checked="" type="checkbox"/>	Low	802.3at		<input type="checkbox"/>	<input checked="" type="checkbox"/>
46	<input checked="" type="checkbox"/>	Low	802.3at		<input type="checkbox"/>	<input checked="" type="checkbox"/>
47	<input checked="" type="checkbox"/>	Low	802.3at		<input type="checkbox"/>	<input checked="" type="checkbox"/>
48	<input checked="" type="checkbox"/>	Low	802.3at		<input type="checkbox"/>	<input checked="" type="checkbox"/>

The following table describes the labels in this screen.

Table 26 Basic Setting > PoE Setup

LABEL	DESCRIPTION
PoE Mode	<p>Select the power management mode you want the Switch to use.</p> <ul style="list-style-type: none"> Classification – Select this if you want the Switch to reserve the maximum power for each PD according to the PD's power class and priority level. If the total power supply runs out, PDs with lower priority do not get power to function. In this mode, the maximum power is reserved based on what you configure in Max Power or the standard power limit for each class. Consumption – Select this if you want the Switch to supply the actual power that the PD needs. The Switch also allocates power based on a port's Max Power and the PD's power class and priority level. The Switch puts a limit on the maximum amount of power the PD can request and use. In this mode, the default maximum power that can be delivered to the PD is 33 W (IEEE 802.3at Class 4) or 22 W (IEEE 802.3af Classes 0 to 3).
Pre-Allocate	Select this to have the Switch pre-allocate power to each port based on the classification of the PD device.
Dual Detection	Select this to have the Switch run another detecting procedure between the detection and classification stages. This helps check if the power interface (PI) range of the connected PD is within the IEEE 802.3af/at standard range and ensures it is an IEEE PD.
Power Up Sequence Delay	Select this to allow PoE ports to be powered up one-by-one randomly or clear to allow them all to be powered up at the same time.
PoE Usage Threshold (%)	Enter a number ranging from 1 to 99 to set the threshold. The Switch will generate a trap and/or log when the actual PoE usage is higher than the specified threshold.
Port	This is the port index number.

Table 26 Basic Setting > PoE Setup (continued)

LABEL	DESCRIPTION
*	<p>Settings in this row apply to all ports.</p> <p>Use this row only if you want to make some settings the same for all ports. Use this row first to set the common settings and then make adjustments on a port-by-port basis.</p> <p>Changes in this row are copied to all the ports as soon as you make them.</p>
Active	<p>Select this to provide power to a PD connected to the port.</p> <p>If left unchecked, the PD connected to the port cannot receive power from the Switch.</p>
Priority	<p>When the total power requested by the PDs exceeds the total PoE power budget on the Switch, you can set the PD priority to allow the Switch to provide power to ports with higher priority.</p> <p>Select Critical to give the highest PD priority on the port.</p> <p>Select High to set the Switch to assign the remaining power to the port after all critical priority ports are served.</p> <p>Select Low to set the Switch to assign the remaining power to the port after all critical and high priority ports are served.</p>
Power-Up	<p>Set how the Switch provides power to a connected PD at power-up.</p> <p>802.3af – the Switch follows the IEEE 802.3af Power over Ethernet standard to supply power to the connected PDs during power-up.</p> <p>Legacy – the Switch can provide power to the connected PDs that require high inrush currents at power-up. Inrush current is the maximum, instantaneous input current drawn by the PD when first turned on.</p> <p>Pre-802.3at – the Switch initially offers power on the port according to the IEEE 802.3af standard, and then switches to support the IEEE 802.3at standard within 75 milliseconds after a PD is connected to the port. Select this option if the Switch is performing 2-event Layer-1 classification (PoE+ hardware classification) or the connected PD is NOT performing Layer 2 power classification using Link Layer Discovery Protocol (LLDP).</p> <p>802.3at – the Switch supports the IEEE 802.3at High Power over Ethernet standard and can supply power of up to 30W per Ethernet port. IEEE 802.3at is also known as PoE+ or PoE Plus. An IEEE 802.3at compatible device is referred to as Type 2. Power Class 4 (High Power) can only be used by Type 2 devices. If the connected PD requires a Class 4 current when it is turned on, it will be powered up in this mode.</p> <p>Force-802.3at – the Switch offers power of up to 33 W on the port without performing PoE hardware classification. Select this option if the connected PD does not comply with any PoE standard and requests power higher than a standard power limit.</p>
Max Power (mW)	<p>Specify the maximum amount of power the PD could use from the Switch on this port. If you leave this field blank, the Switch refers to the standard or default maximum power for each class.</p>
Wide Range Detection	<p>Select this to let the Switch have a wider detection range for the PD.</p> <p>The Switch detects whether a connected device is a powered device or not before supplying power to the port. For the PD detection, the Switch applies a fixed voltage to the device and then receives returned current. If the returned current is within the IEEE 802.3AF/AT standard range, the device will be considered as a valid PD by the Switch.</p> <p>However, in real cases, environmental interferences might easily cause the returned current to be out of the standard range.</p>

Table 26 Basic Setting > PoE Setup (continued)

LABEL	DESCRIPTION
LLDP Power Via MDI	<p>Select this to have the Switch negotiate PoE power with the PD connected to the port by transmitting LLDP Power Via MDI TLV frames. This helps the Switch allocate less power to the PD on this port. The connected PD must be able to request PoE power through LLDP.</p> <p>The Power Via MDI TLV allows PoE devices to advertise and discover the MDI power support capabilities of the sending port on the remote device.</p> <ul style="list-style-type: none"> • Port Class • MDI Supported • MDI Enabled • Pair Controllable • PSE Power Pairs • Power Class
Apply	Click Apply to save your changes to the Switch's run-time memory. The Switch loses these changes if it is turned off or loses power, so use the Save link on the top navigation panel to save your changes to the non-volatile memory when you are done configuring.
Cancel	Click Cancel to begin configuring this screen afresh.

8.9 Interface Setup

An IPv6 address is configured on a per-interface basis. The interface can be a physical interface (for example, an Ethernet port) or a virtual interface (for example, a VLAN). The Switch supports the VLAN interface type for IPv6 at the time of writing.

Use this screen to set IPv6 interfaces on which you can configure an IPv6 address to access and manage the Switch.

Click **Basic Setting** > **Interface Setup** in the navigation panel to display the configuration screen.

Figure 75 Basic Setting > Interface Setup

The screenshot shows the 'Interface Setup' configuration page. At the top, there is a title bar 'Interface Setup'. Below it, there are two input fields: 'Interface Type' with a dropdown menu showing 'VLAN' and 'Interface ID' with an empty text box. Below these fields are two buttons: 'Add' and 'Cancel'. At the bottom, there is a table with columns: 'Index', 'Interface Type', 'Interface ID', and 'Interface'. Below the table are two buttons: 'Delete' and 'Cancel'.

The following table describes the labels in this screen.

Table 27 Basic Setting > Interface Setup

LABEL	DESCRIPTION
Interface Type	Select the type of IPv6 interface for which you want to configure. The Switch supports the VLAN interface type for IPv6 at the time of writing.
Interface ID	Specify a unique identification number (from 1 to 4094) for the interface. To have IPv6 function properly, you should configure a static VLAN with the same ID number in the Advanced Application > VLAN screens.
Add	Click this to create a new entry. This saves your changes to the Switch's run-time memory. The Switch loses these changes if it is turned off or loses power, so use the Save link on the top navigation panel to save your changes to the non-volatile memory when you are done configuring.
Cancel	Click Cancel to reset the fields to your previous configuration.
Index	This field displays the index number of an entry.
Interface Type	This field displays the type of interface.
Interface ID	This field displays the identification number of the interface.
Interface	This field displays the interface's descriptive name which is generated automatically by the Switch. The name is from a combination of the interface type and ID number.
	Select an entry's check box to select a specific entry. Otherwise, select the check box in the table heading row to select all entries.
Delete	Click Delete to remove the selected entry from the summary table.
Cancel	Click Cancel to clear the check boxes.

8.10 IPv6

Use this screen to view the IPv6 interface status and configure Switch's management IPv6 addresses.

8.10.1 IPv6 Status

Click **Basic Setting > IPv6** in the navigation panel to display the IPv6 status screen as shown next.

Figure 76 Basic Setting > IPv6

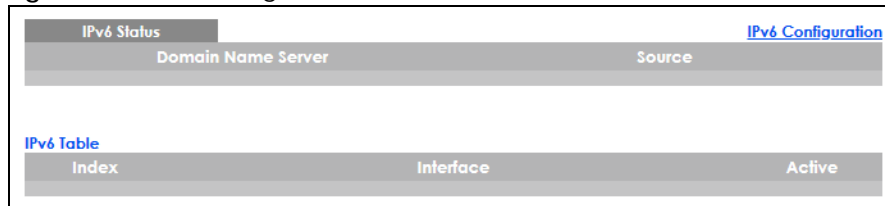

The following table describes the labels in this screen.

Table 28 Basic Setting > IPv6

LABEL	DESCRIPTION
IPv6 Status	
Domain Name Server	This field displays the IP address of the DNS server.

Table 28 Basic Setting > IPv6

LABEL	DESCRIPTION
Source	This field displays whether the DNS server address is configured manually (Static) or obtained automatically using DHCPv6 .
IPv6 Table	
Index	This field displays the index number of an IPv6 interface. Click on an index number to view more interface details.
Interface	This is the name of the IPv6 interface you created.
Active	This field displays whether the IPv6 interface is activated or not.

8.10.2 IPv6 Interface Status

Use this screen to view a specific IPv6 interface status and detailed information. Click an interface index number in the **Basic Setting > IPv6** screen. The following screen opens.

Figure 77 Basic Setting > IPv6 > IPv6 Interface Status

IPv6 Interface Status		IPv6 Status
Interface: VLAN100		
IPv6 Active	disable	
MTU Size		
ICMPv6 Rate Limit Bucket Size		
ICMPv6 Rate Limit Error Interval		
Stateless Address Autoconfig		
Link Local Address		
Global Unicast Address(es)		
Joined Group Address(es)		
ND DAD Active		
Number of DAD Attempts		
NS-Interval (millisecond)		
ND Reachable Time (millisecond)		
DHCPv6 Client Active	No	
Identity Association	IA Type	
	IAID	
	T1	
	T2	
	State	
	SID	
	Address	
	Preferred Lifetime	
Valid Lifetime		
DNS		
Domain List		
Restart DHCPv6 Client	Click Here	

The following table describes the labels in this screen.

Table 29 Basic Setting > IPv6 > IPv6 Interface Status

LABEL	DESCRIPTION
IPv6 Active	This field displays whether the IPv6 interface is activated or not.
MTU Size	This field displays the Maximum Transmission Unit (MTU) size for IPv6 packets on this interface.
ICMPv6 Rate Limit Bucket Size	This field displays the maximum number of ICMPv6 error messages which are allowed to transmit in a given time interval. If the bucket is full, subsequent error messages are suppressed.
ICMPv6 Rate Limit Error Interval	This field displays the time period (in milliseconds) during which ICMPv6 error messages of up to the bucket size can be transmitted. 0 means no limit.
Stateless Address Autoconfig	This field displays whether the Switch's interface can automatically generate a link-local address via stateless auto-configuration.
Link Local Address	This field displays the Switch's link-local IP address and prefix generated by the interface. It also shows whether the IP address is preferred, which means it is a valid address and can be used as a sender or receiver address.
Global Unicast Address(es)	This field displays the Switch's global unicast address to identify this interface.
Joined Group Address(es)	This field displays the IPv6 multicast addresses of groups the Switch's interface joins.
ND DAD Active	This field displays whether Neighbor Discovery (ND) Duplicate Address Detection (DAD) is enabled on the interface.
Number of DAD Attempts	This field displays the number of consecutive neighbor solicitations the Switch sends for this interface.
NS-Interval (millisecond)	This field displays the time interval (in milliseconds) at which neighbor solicitations are re-sent for this interface.
ND Reachable Time (millisecond)	This field displays how long (in milliseconds) a neighbor is considered reachable for this interface.
DHCPv6 Client Active	This field displays whether the Switch acts as a DHCPv6 client to get an IPv6 address from a DHCPv6 server.
Identity Association	An Identity Association (IA) is a collection of addresses assigned to a DHCP client, through which the server and client can manage a set of related IP addresses. Each IA must be associated with exactly one interface.
IA Type	The IA type is the type of address in the IA. Each IA holds one type of address. IA_NA means an identity association for non-temporary addresses and IA_TA is an identity association for temporary addresses.
IAID	Each IA consists of a unique IAID and associated IP information.
T1	This field displays the DHCPv6 T1 timer. After T1, the Switch sends the DHCPv6 server a Renew message. An IA_NA option contains the T1 and T2 fields, but an IA_TA option does not. The DHCPv6 server uses T1 and T2 to control the time at which the client contacts with the server to extend the lifetimes on any addresses in the IA_NA before the lifetimes expire.
T2	This field displays the DHCPv6 T2 timer. If the time T2 is reached and the server does not respond, the Switch sends a Rebind message to any available server.

Table 29 Basic Setting > IPv6 > IPv6 Interface Status (continued)

LABEL	DESCRIPTION
State	This field displays the state of the TA. It shows Active when the Switch obtains addresses from a DHCPv6 server and the TA is created. Renew when the TA's address lifetime expires and the Switch sends out a Renew message. Rebind when the Switch does not receive a response from the original DHCPv6 server and sends out a Rebind message to another DHCPv6 server.
SID	This field displays the DHCPv6 server's unique ID.
Address	This field displays the Switch's global address which is assigned by the DHCPv6 server.
Preferred Lifetime	This field displays how long (in seconds) that the global address remains preferred.
Valid Lifetime	This field displays how long (in seconds) that the global address is valid.
DNS	This field displays the DNS server address assigned by the DHCPv6 server.
Domain List	This field displays the address record when the Switch queries the DNS server to resolve domain names.
Restart DHCPv6 Client	Click Click Here to send a new DHCP request to the DHCPv6 server and update the IPv6 address and DNS information for this interface.

8.10.3 IPv6 Configuration

Use this screen to configure IPv6 settings on the Switch. Click the **IPv6 Configuration** link in the **Basic Setting > IPv6** screen. The following screen opens.

Figure 78 Basic Setting > IPv6 > IPv6 Configuration

IPv6 Configuration		IPv6 Status
IPv6 Global Setup		Click Here
IPv6 Interface Setup		Click Here
IPv6 Addressing	IPv6 Link-Local Address Setup	Click Here
	IPv6 Global Address Setup	Click Here
IPv6 Neighbor Discovery	IPv6 Neighbor Discovery Setup	Click Here
IPv6 Neighbor Setup		Click Here
DHCPv6 Client Setup		Click Here

The following table describes the labels in this screen.

Table 30 Basic Setting > IPv6 > IPv6 Configuration

LABEL	DESCRIPTION
IPv6 Global Setup	Click the link to go to a screen where you can configure the global IPv6 settings on the Switch.
IPv6 Interface Setup	Click the link to go to a screen where you can enable an IPv6 interface on the Switch.
IPv6 Addressing	
IPv6 Link-Local Address Setup	Click the link to go to a screen where you can configure the IPv6 link-local address for an interface.
IPv6 Global Address Setup	Click the link to go to a screen where you can configure the IPv6 global address for an interface.

Table 30 Basic Setting > IPv6 > IPv6 Configuration (continued)

LABEL	DESCRIPTION
IPv6 Neighbor Discovery	
IPv6 Neighbor Discovery Setup	Click the link to go to a screen where you can configure the IPv6 neighbor discovery settings.
IPv6 Neighbor Setup	Click the link to go to a screen where you can create a static IPv6 neighbor entry in the Switch's IPv6 neighbor table.
DHCPv6 Client Setup	Click the link to go to a screen where you can configure the Switch DHCPv6 client settings.

8.10.4 IPv6 Global Setup

Use this screen to configure the global IPv6 settings. Click the link next to **IPv6 Global Setup** in the **IPv6 Configuration** screen to display the screen as shown next.

Figure 79 Basic Setting > IPv6 > IPv6 Configuration > IPv6 Global Setup

IPv6 Global Setup		IPv6 Configuration
IPv6 Hop Limit	64	
ICMPv6 Rate Limit Bucket Size	100	
ICMPv6 Rate Limit Error Interval	1000	milliseconds
<input type="button" value="Apply"/> <input type="button" value="Cancel"/> <input type="button" value="Clear"/>		

The following table describes the labels in this screen.

Table 31 Basic Setting > IPv6 > IPv6 Configuration > IPv6 Global Setup

LABEL	DESCRIPTION
IPv6 Hop Limit	Specify the maximum number of hops (from 1 to 255) in router advertisements. This is the maximum number of hops on which an IPv6 packet is allowed to transmit before it is discarded by an IPv6 router, which is similar to the TTL field in IPv4.
ICMPv6 Rate Limit Bucket Size	Specify the maximum number of ICMPv6 error messages (from 1 to 200) which are allowed to transmit in a given time interval. If the bucket is full, subsequent error messages are suppressed.
ICMPv6 Rate Limit Error Interval	Specify the time period (from 0 to 2147483647 milliseconds) during which ICMPv6 error messages of up to the bucket size can be transmitted. 0 means no limit.
Apply	Click Apply to save your changes to the Switch's run-time memory. The Switch loses these changes if it is turned off or loses power, so use the Save link on the top navigation panel to save your changes to the non-volatile memory when you are done configuring.
Cancel	Click Cancel to begin configuring this screen afresh.
Clear	Click Clear to reset the fields to the factory defaults.

8.10.5 IPv6 Interface Setup

Use this screen to turn on or off an IPv6 interface. Click the link next to **IPv6 Interface Setup** in the **IPv6 Configuration** screen to display the screen as shown next.

Figure 80 Basic Setting > IPv6 > IPv6 Configuration > IPv6 Interface Setup

Index	Interface	Active	Address Autoconfig
1	VLAN100	No	No

The following table describes the labels in this screen.

Table 32 Basic Setting > IPv6 > IPv6 Configuration > IPv6 Interface Setup

LABEL	DESCRIPTION
Interface	Select the IPv6 interface you want to configure.
Active	Select this option to enable the interface.
Address Autoconfig	Select this option to allow the interface to automatically generate a link-local address via stateless auto-configuration.
Apply	Click Apply to save your changes to the Switch's run-time memory. The Switch loses these changes if it is turned off or loses power, so use the Save link on the top navigation panel to save your changes to the non-volatile memory when you are done configuring.
Cancel	Click Cancel to begin configuring this screen afresh.
Clear	Click Clear to reset the fields to the factory defaults.
Index	This is the interface index number. Click on an index number to change the settings.
Interface	This is the name of the IPv6 interface you created.
Active	This field displays whether the IPv6 interface is activated or not.

8.10.6 IPv6 Link-Local Address Setup

A link-local address uniquely identifies a device on the local network (the LAN). It is similar to a "private IP address" in IPv4. You can have the same link-local address on multiple interfaces on a device. A link-local unicast address has a predefined prefix of fe80::/10.

Use this screen to configure the interface's link-local address and default gateway. Click the link next to **IPv6 Link-Local Address Setup** in the **IPv6 Configuration** screen to display the screen as shown next.

Figure 81 Basic Setting > IPv6 > IPv6 Configuration > IPv6 Link-Local Address Setup

Index	Interface	IPv6 Link-Local Address	IPv6 Default Gateway
1	VLAN100		

The following table describes the labels in this screen.

Table 33 Basic Setting > IPv6 > IPv6 Configuration > IPv6 Link-Local Address Setup

LABEL	DESCRIPTION
Interface	Select the IPv6 interface you want to configure.
Link-Local Address	Manually configure a static IPv6 link-local address for the interface.
Default Gateway	Set the default gateway IPv6 address for the interface. When an interface cannot find a routing information for a frame's destination, it forwards the packet to the default gateway.
Apply	Click Apply to save your changes to the Switch's run-time memory. The Switch loses these changes if it is turned off or loses power, so use the Save link on the top navigation panel to save your changes to the non-volatile memory when you are done configuring.
Cancel	Click Cancel to begin configuring this screen afresh.
Clear	Click Clear to reset the fields to the factory defaults.
Index	This is the interface index number. Click on an index number to change the settings.
Interface	This is the name of the IPv6 interface you created.
IPv6 Link-Local Address	This is the static IPv6 link-local address for the interface.
IPv6 Default Gateway	This is the default gateway IPv6 address for the interface.

8.10.7 IPv6 Global Address Setup

Use this screen to configure the interface's IPv6 global address. Click the link next to **IPv6 Global Address Setup** in the **IPv6 Configuration** screen to display the screen as shown next.

Figure 82 Basic Setting > IPv6 > IPv6 Configuration > IPv6 Global Address Setup

The following table describes the labels in this screen.

Table 34 Basic Setting > IPv6 > IPv6 Configuration > IPv6 Global Address Setup

LABEL	DESCRIPTION
Domain Name Server 1/2	Enter a domain name server IPv6 address in order to be able to use a domain name instead of an IP address.
Apply	Click Apply to save your changes to the Switch's run-time memory. The Switch loses these changes if it is turned off or loses power, so use the Save link on the top navigation panel to save your changes to the non-volatile memory when you are done configuring.
Cancel	Click this to reset the Domain Name Server values in this screen to their last-saved values.
Interface	Select the IPv6 interface you want to configure.
IPv6 Global Address	Manually configure a static IPv6 global address for the interface.
Prefix Length	Specify an IPv6 prefix length that specifies how many most significant bits (start from the left) in the address compose the network address.
EUI-64	Select this option to have the interface ID be generated automatically using the EUI-64 format.
Add	Click this to create a new entry. This saves your changes to the Switch's run-time memory. The Switch loses these changes if it is turned off or loses power, so use the Save link on the top navigation panel to save your changes to the non-volatile memory when you are done configuring.
Cancel	Click Cancel to begin configuring this screen afresh.
Clear	Click Clear to reset the fields to the factory defaults.
Index	This is the interface index number. Click on an index number to change the settings.
Interface	This is the name of the IPv6 interface you created.
IPv6 Global Address/Prefix Length	This field displays the IPv6 global address and prefix length for the interface.
EUI-64	This shows whether the interface ID of the global address is generated using the EUI-64 format.
	Select an entry's check box to select a specific entry. Otherwise, select the check box in the table heading row to select all entries.

Table 34 Basic Setting > IPv6 > IPv6 Configuration > IPv6 Global Address Setup (continued)

LABEL	DESCRIPTION
Delete	Check the entries that you want to remove and then click Delete to remove the selected entries from the summary table.
Cancel	Click Cancel to clear the check boxes.

8.10.8 IPv6 Neighbor Discovery Setup

Use this screen to configure neighbor discovery settings for each interface. Click the link next to **IPv6 Neighbor Discovery Setup** in the **IPv6 Configuration** screen to display the screen as shown next.

Figure 83 Basic Setting > IPv6 > IPv6 Configuration > IPv6 Neighbor Discovery Setup

Index	Interface	DAD Attempts	NS Interval	Reachable Time
1	VLAN100	1	1000	30000

The following table describes the labels in this screen.

Table 35 Basic Setting > IPv6 > IPv6 Configuration > IPv6 Neighbor Discovery Setup

LABEL	DESCRIPTION
Interface	Select the IPv6 interface you want to configure.
DAD Attempts	The Switch uses Duplicate Address Detection (DAD) with neighbor solicitation and advertisement messages to check whether an IPv6 address is already in use before assigning it to an interface. Specify the number of consecutive neighbor solicitations (from 0 to 600) the Switch sends for this interface. Enter 0 to turn off DAD.
NS Interval	Specify the time interval (from 1000 to 3600000 milliseconds) at which neighbor solicitations are re-sent for this interface.
Reachable Time	Specify how long (from 1000 to 3600000 milliseconds) a neighbor is considered reachable for this interface.
Apply	Click Apply to save your changes to the Switch's run-time memory. The Switch loses these changes if it is turned off or loses power, so use the Save link on the top navigation panel to save your changes to the non-volatile memory when you are done configuring.
Cancel	Click Cancel to begin configuring this screen afresh.
Clear	Click Clear to reset the fields to the factory defaults.
Index	This is the interface index number. Click on an index number to change the settings.
Interface	This is the name of the IPv6 interface you created.
DAD Attempts	This field displays the number of consecutive neighbor solicitations the Switch sends for this interface.

Table 35 Basic Setting > IPv6 > IPv6 Configuration > IPv6 Neighbor Discovery Setup (continued)

LABEL	DESCRIPTION
NS Interval	This field displays the time interval (in milliseconds) at which neighbor solicitations are re-sent for this interface.
Reachable Time	This field displays how long (in milliseconds) a neighbor is considered reachable for this interface.

8.10.9 IPv6 Neighbor Setup

Use this screen to create a static IPv6 neighbor entry in the Switch's IPv6 neighbor table to store the neighbor information permanently. Click the link next to **IPv6 Neighbor Setup** in the **IPv6 Configuration** screen to display the screen as shown next.

Figure 84 Basic Setting > IPv6 > IPv6 Configuration > IPv6 Neighbor Setup

The following table describes the labels in this screen.

Table 36 Basic Setting > IPv6 > IPv6 Configuration > IPv6 Neighbor Setup

LABEL	DESCRIPTION
Interface Type	Select the type of IPv6 interface for which you want to configure. The Switch supports the VLAN interface type for IPv6 at the time of writing.
Interface ID	Specify a unique identification number (from 1 to 4094) for the interface. A static IPv6 neighbor entry displays in the Management > IPv6 Neighbor Table screen only when the interface ID is also created in the Basic Setup > Interface Setup screen. To have IPv6 function properly, you should configure a static VLAN with the same ID number in the Advanced Application > VLAN screens.
Neighbor Address	Specify the IPv6 address of the neighboring device which can be reached through the interface.
MAC	Specify the MAC address of the neighboring device which can be reached through the interface.
Add	Click this to create a new entry or to update an existing one. This saves your changes to the Switch's run-time memory. The Switch loses these changes if it is turned off or loses power, so use the Save link on the top navigation panel to save your changes to the non-volatile memory when you are done configuring.
Cancel	Click Cancel to begin configuring this screen afresh.

Table 36 Basic Setting > IPv6 > IPv6 Configuration > IPv6 Neighbor Setup (continued)

LABEL	DESCRIPTION
Clear	Click Clear to reset the fields to the factory defaults.
Index	This is the interface index number. Click on an index number to change the settings.
Interface	This is the name of the IPv6 interface you created.
Neighbor Address	This field displays the IPv6 address of the neighboring device which can be reached through the interface.
MAC	This field displays the MAC address of the neighboring device which can be reached through the interface.
	Select an entry's check box to select a specific entry. Otherwise, select the check box in the table heading row to select all entries.
Delete	Check the entries that you want to remove and then click Delete to remove the selected entries from the summary table.
Cancel	Click Cancel to clear the check boxes.

8.10.10 DHCPv6 Client Setup

Use this screen to configure the Switch's DHCP settings when it is acting as a DHCPv6 client. Click the link next to **DHCPv6 Client Setup** in the **IPv6 Configuration** screen to display the screen as shown next.

Figure 85 Basic Setting > IPv6 > IPv6 Configuration > DHCPv6 Client Setup

Index	Interface	IA-NA	Rapid-Commit	DNS	Domain-List	Information Refresh Minimum
1	VLAN100	No	No	No	No	86400

The following table describes the labels in this screen.

Table 37 Basic Setting > IPv6 > IPv6 Configuration > DHCPv6 Client Setup

LABEL	DESCRIPTION
Interface	Select the IPv6 interface you want to configure.
IA Type	Select IA-NA to set the Switch to get a non-temporary IP address from the DHCPv6 server for this interface. Optionally, you can also select Rapid-Commit to have the Switch send its DHCPv6 Solicit message with a Rapid Commit option to obtain information from the DHCPv6 server by a rapid two-message exchange. The Switch discards any Reply messages that do not include a Rapid Commit option. The DHCPv6 server should also support the Rapid Commit option to have it work well.
Options	Select DNS to have the Switch obtain DNS server IPv6 addresses and/or select Domain-List to have the Switch obtain a list of domain names from the DHCP server.

Table 37 Basic Setting > IPv6 > IPv6 Configuration > DHCPv6 Client Setup (continued)

LABEL	DESCRIPTION
Information Refresh Minimum	Specify the time interval (from 600 to 4294967295 seconds) at which the Switch exchanges other configuration information with a DHCPv6 server again.
Apply	Click Apply to save your changes to the Switch's run-time memory. The Switch loses these changes if it is turned off or loses power, so use the Save link on the top navigation panel to save your changes to the non-volatile memory when you are done configuring.
Cancel	Click Cancel to begin configuring this screen afresh.
Clear	Click Clear to reset the fields to the factory defaults.
Index	This is the interface index number. Click on an index number to change the settings.
Interface	This is the name of the IPv6 interface you created.
IA-NA	This field displays whether the Switch obtains a non-temporary IP address from the DHCPv6 server.
Rapid-Commit	This field displays whether the Switch obtains information from the DHCPv6 server by a rapid two-message exchange.
DNS	This field displays whether the Switch obtains DNS server IPv6 addresses from the DHCPv6 server.
Domain-List	This field displays whether the Switch obtains a list of domain names from the DHCP server.
Information Refresh Minimum	This field displays the time interval (in seconds) at which the Switch exchanges other configuration information with a DHCPv6 server again.

8.11 Cloud Management

The Zyxel Nebula Control Center (NCC) is a cloud-based network management system that allows you to remotely manage and monitor Zyxel Nebula APs, Ethernet switches and security gateways.

The Switch is managed and provisioned automatically by the NCC (Nebula Control Center) when:

- It is connected to the Internet.
- The **Nebula Control Center Discovery** feature is enabled.
- It has been registered in the NCC.

This screen displays links to **Nebula Control Center Discovery** where you can have the Switch search for the NCC (Nebula Control Center) and to **Nebula Switch Registration** which has a QR code containing the Switch's serial number and MAC address for handy registration of the Switch at NCC.

Click **Basic Setting** > **Cloud Management** in the navigation panel to display this screen.

Figure 86 Basic Setting > Cloud Management

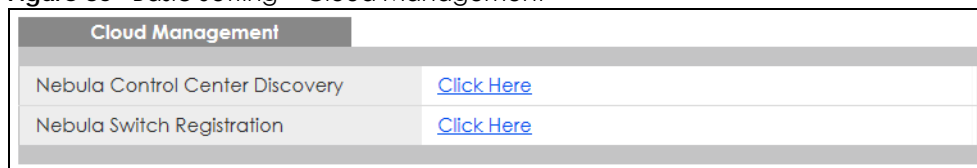

8.11.1 Nebula Center Control Discovery

Click **Basic Setting** > **Cloud Management** > **Nebula Control Center Discovery** to display this screen.

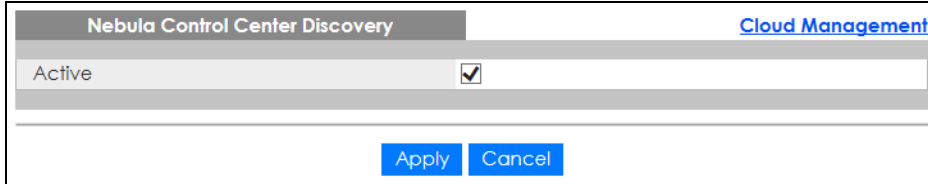
Figure 87 Basic Setting > Cloud Management > Nebula Control Center Discovery

Select **Active** to turn on NCC discovery on the Switch. If the Switch has Internet access and has been registered in the NCC, it will go into cloud management mode.

In cloud management mode, then NCC will first check if the firmware on the Switch needs to be upgraded. If it does, the Switch will upgrade the firmware immediately. If the firmware does not need to be upgraded, but there is newer firmware available for the Switch, then it will be upgraded according to the firmware upgrade schedule for the Switch on the NCC. Below is the process for upgrading firmware:

- 1 Download firmware via the NCC.
- 2 Upgrade the firmware and reboot.

Note: While the Switch is rebooting, do NOT turn off the power.

Clear **Active** to turn off NCC discovery on the Switch. The Switch will NOT discover the NCC and remain in standalone mode.

8.11.2 Nebula Switch Registration

Click **Basic Setting > Cloud Management > Nebula Switch Registration** to display this screen.

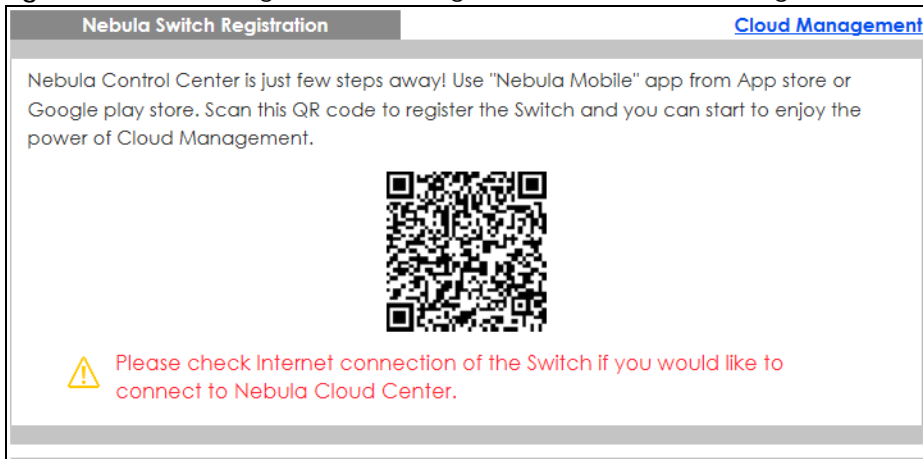
Figure 88 Basic Setting > Cloud Management > Nebula Switch Registration

This screen has a QR code containing the Switch's serial number and MAC address for handy NCC registration of the Switch using the Nebula Mobile app. First, download the app from the Google Play store for Android devices or the App Store for iOS devices and create an organization and site.

CHAPTER 9

VLAN

9.1 Overview

This chapter shows you how to configure 802.1Q tagged and port-based VLANs.

The type of screen you see here depends on the **VLAN Type** you selected in the **Switch Setup** screen.

9.1.1 What You Can Do

- Use the **VLAN** screen ([Section 9.3 on page 117](#)) to view and search all static VLAN groups.
- Use the **VLAN Detail** screen ([Section 9.3.1 on page 118](#)) to view detailed port settings and status of the static VLAN group.
- Use the **Static VLAN Setup** screen ([Section 9.5 on page 120](#)) to configure a static VLAN for the Switch.
- Use the **VLAN Port Setup** screen ([Section 9.6 on page 121](#)) to configure the static VLAN (IEEE 802.1Q) settings on a port.
- Use the **Subnet Based VLAN Setup** screen ([Section 9.7 on page 123](#)) to set up VLANs that allow you to group traffic into logical VLANs based on the source IP subnet you specify.
- Use the **Protocol Based VLAN Setup** screen ([Section 9.8 on page 125](#)) to set up VLANs that allow you to group traffic into logical VLANs based on the protocol you specify.
- Use the **Voice VLAN Setup** screen ([Section 9.9 on page 127](#)) to set up VLANs that allow you to group voice traffic with defined priority and enable the Switch port to carry the voice traffic separately from data traffic to ensure the sound quality does NOT deteriorate.
- Use the **MAC Based VLAN Setup** screen ([Section 9.10 on page 129](#)) to set up VLANs that allow you to group untagged packets into logical VLANs based on the source MAC address of the packet. This eliminates the need to reconfigure the Switch when you change ports. The Switch will forward the packets based on the source MAC address you set up previously.
- Use the **Vendor ID Based VLAN Setup** screen ([Section 9.11 on page 130](#)) to set up VLANs that allow you to group untagged packets into logical VLANs based on the source MAC address of the packet. You can specify a mask for the MAC address to create a MAC address filter and enter a weight to set the VLAN rule's priority.
- Use the **Port-Based VLAN Setup** screen ([Section 9.12 on page 132](#)) to set up VLANs where the packet forwarding decision is based on the destination MAC address and its associated port.

9.1.2 What You Need to Know

Read this section to know more about VLAN and how to configure the screens.

9.2 Introduction to IEEE 802.1Q Tagged VLANs

A tagged VLAN uses an explicit tag (VLAN ID) in the MAC header to identify the VLAN membership of a

frame across bridges – they are not confined to the switch on which they were created. The VLANs can be created statically by hand dynamically through GVRP. The VLAN ID associates a frame with a specific VLAN and provides the information that switches need to process the frame across the network. A tagged frame is 4 bytes longer than an untagged frame and contains 2 bytes of TPID (Tag Protocol Identifier, residing within the type or length field of the Ethernet frame) and 2 bytes of TCI (Tag Control Information, starts after the source address field of the Ethernet frame).

The CFI (Canonical Format Indicator) is a single-bit flag, always set to zero for Ethernet switches. If a frame received at an Ethernet port has a CFI set to 1, then that frame should not be forwarded as it is to an untagged port. The remaining twelve bits define the VLAN ID, giving a possible maximum number of 4,096 VLANs. Note that user priority and VLAN ID are independent of each other. A frame with VID (VLAN Identifier) of null (0) is called a priority frame, meaning that only the priority level is significant and the default VID of the ingress port is given as the VID of the frame. Of the 4096 possible VIDs, a VID of 0 is used to identify priority frames and value 4095 (FFF) is reserved, so the maximum possible VLAN configurations are 4,094.

TPID	User Priority	CFI	VLAN ID
2 Bytes	3 Bits	1 Bit	12 bits

Forwarding Tagged and Untagged Frames

Each port on the Switch is capable of passing tagged or untagged frames. To forward a frame from an 802.1Q VLAN-aware switch to an 802.1Q VLAN-unaware switch, the Switch first decides where to forward the frame and then strips off the VLAN tag. To forward a frame from an 802.1Q VLAN-unaware switch to an 802.1Q VLAN-aware switch, the Switch first decides where to forward the frame, and then inserts a VLAN tag reflecting the ingress port's default VID. The default PVID is VLAN 1 for all ports, but this can be changed.

A broadcast frame (or a multicast frame for a multicast group that is known by the system) is duplicated only on ports that are members of the VID (except the ingress port itself), thus confining the broadcast to a specific domain.

9.2.0.1 Automatic VLAN Registration

GARP and GVRP are the protocols used to automatically register VLAN membership across switches.

GARP

GARP (Generic Attribute Registration Protocol) allows network switches to register and de-register attribute values with other GARP participants within a bridged LAN. GARP is a protocol that provides a generic mechanism for protocols that serve a more specific application, for example, GVRP.

GARP Timers

Switches join VLANs by making a declaration. A declaration is made by issuing a Join message using GARP. Declarations are withdrawn by issuing a Leave message. A Leave All message terminates all registrations. GARP timers set declaration timeout values.

GVRP

GVRP (GARP VLAN Registration Protocol) is a registration protocol that defines a way for switches to register necessary VLAN members on ports across the network. Enable this function to permit VLAN groups beyond the local Switch.

Please refer to the following table for common IEEE 802.1Q VLAN terminology.

Table 38 IEEE 802.1Q VLAN Terminology

VLAN PARAMETER	TERM	DESCRIPTION
VLAN Type	Permanent VLAN	This is a static VLAN created manually.
	Dynamic VLAN	This is a VLAN configured by a GVRP registration or de-registration process.
VLAN Administrative Control	Registration Fixed	Fixed registration ports are permanent VLAN members.
	Registration Forbidden	Ports with registration forbidden are forbidden to join the specified VLAN.
	Normal Registration	Ports dynamically join a VLAN using GVRP.
VLAN Tag Control	Tagged	Ports belonging to the specified VLAN tag all outgoing frames transmitted.
	Untagged	Ports belonging to the specified VLAN do not tag all outgoing frames transmitted.
VLAN Port	Port VID	This is the VLAN ID assigned to untagged frames that this port received.
	Acceptable Frame Type	You may choose to accept both tagged and untagged incoming frames, just tagged incoming frames or just untagged incoming frames on a port.
	Ingress filtering	If set, the Switch discards incoming frames for VLANs that do not have this port as a member.

9.2.0.2 Port VLAN Trunking

Enable **VLAN Trunking** on a port to allow frames belonging to unknown VLAN groups to pass through that port. This is useful if you want to set up VLAN groups on end devices without having to configure the same VLAN groups on intermediary devices.

Refer to the following figure. Suppose you want to create VLAN groups 1 and 2 (V1 and V2) on devices A and B. Without **VLAN Trunking**, you must configure VLAN groups 1 and 2 on all intermediary switches C, D and E; otherwise they will drop frames with unknown VLAN group tags. However, with **VLAN Trunking** enabled on ports in each intermediary switch you only need to create VLAN groups in the end devices (A and B). C, D and E automatically allow frames with VLAN group tags 1 and 2 (VLAN groups that are unknown to those switches) to pass through their VLAN trunking ports.

Figure 89 Port VLAN Trunking

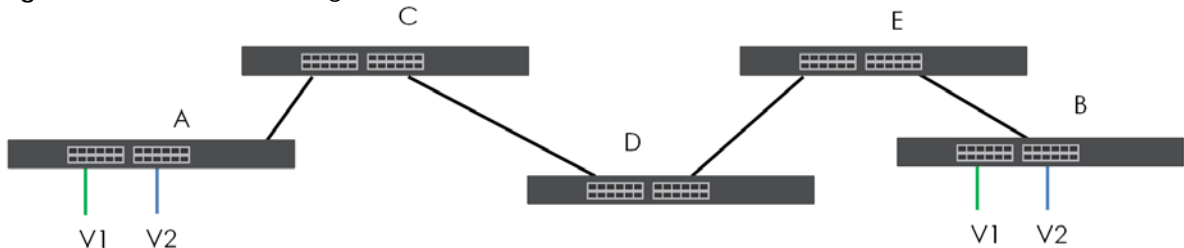

9.2.0.3 Select the VLAN Type

Select a VLAN type in the **Basic Setting > Switch Setup** screen.

Figure 90 Basic Setting > Switch Setup > Select VLAN Type

Switch Setup			
VLAN Type		<input checked="" type="radio"/> 802.1Q <input type="radio"/> Port Based	
MAC Address Learning	Aging Time	300	seconds
ARP Aging Time	Aging Time	300	seconds
GARP Timer	Join Timer	200	milliseconds
	Leave Timer	600	milliseconds
	Leave All Timer	10000	milliseconds
Priority Queue Assignment	Priority7	7	▼
	Priority6	6	▼
	Priority5	5	▼
	Priority4	4	▼
	Priority3	3	▼
	Priority2	1	▼
	Priority1	0	▼
	Priority0	2	▼
<input type="button" value="Apply"/> <input type="button" value="Cancel"/>			

802.1Q Static VLAN

Make sure 802.1Q is selected in the **Basic Setting > Switch Setup** screen.

Use a static VLAN to decide whether an incoming frame on a port should be

- sent to a VLAN group as normal depending on its VLAN tag.
- sent to a group whether it has a VLAN tag or not.
- blocked from a VLAN group regardless of its VLAN tag.

You can also tag all outgoing frames (that were previously untagged) from a port with the specified VID.

9.3 VLAN Status

Use this screen to view and search all static VLAN groups. Click **Advanced Application > VLAN** from the navigation panel to display the **VLAN Status** screen as shown next.

Figure 91 Advanced Application > VLAN: VLAN Status

VLAN Status		VLAN Configuration				
VLAN Search by VID		<input type="text"/>	Search			
The Number of VLAN: 2.						
Index	VID	Name	Tagged Port	Untagged Port	Elapsed Time	Status
1	1	1		1-6	98:24:33	Static
2	123	VLAN123			67:30:19	Static
Change Pages		Previous	Next			

The following table describes the labels in this screen.

Table 39 Advanced Application > VLAN: VLAN Status

LABEL	DESCRIPTION
VLAN Search by VID	Enter an existing VLAN ID numbers (use a comma (,) to separate individual VLANs or a dash (-) to indicate a range of VLANs. For example, "3,4" or "3-9") and click Search to display only the specified VLANs in the list below. Leave this field blank and click Search to display all VLANs configured on the Switch.
The Number of VLAN	This is the number of VLANs configured on the Switch.
The Number of Search Results	This is the number of VLANs that match the searching criteria and display in the list below. This field displays only when you use the Search button to look for certain VLANs.
Index	This is the VLAN index number. Click on an index number to view more VLAN details.
VID	This is the VLAN identification number that was configured in the corresponding VLAN configuration screen.
Name	This fields shows the descriptive name of the VLAN.
Tagged Port	This field shows the tagged ports that are participating in the VLAN.
Untagged Port	This field shows the untagged ports that are participating in the VLAN.
Elapsed Time	This field shows how long it has been since a normal VLAN was registered or a static VLAN was set up.
Status	This field shows how this VLAN was added to the Switch. Static: added as a permanent entry.
Change Pages	Click Previous or Next to show the previous or next screen if all status information cannot be seen in one screen.

9.3.1 VLAN Details

Use this screen to view detailed port settings and status of the static VLAN group. Click on an index number in the **VLAN Status** screen to display VLAN details.

Figure 92 Advanced Application > VLAN > VLAN Detail

VLAN Detail		Port Number																				VLAN Status						
VID		2	4	6	8	10	12	14	16	18	20	22	24	26	28	30	32	34	36	38	40	42	44	46	48	50	Elapsed Time	Status
1		U	U	U	U	U	U	U	U	U	U	U	U	U	U	U	U	U	U	U	U	U	U	U	U	U	8:21:08	Static

The following table describes the labels in this screen.

Table 40 Advanced Application > VLAN > VLAN Detail

LABEL	DESCRIPTION
VLAN Status	Click this to go to the VLAN Status screen.
VID	This is the VLAN identification number that was configured in the corresponding VLAN configuration screen.
Port Number	This column displays the ports that are participating in a VLAN. A tagged port is marked as T , an untagged port is marked as U and ports not participating in a VLAN are marked as "-" .
Elapsed Time	This field shows how long it has been since a normal VLAN was registered or a static VLAN was set up.
Status	This field shows how this VLAN was added to the Switch. Dynamic: using GVRP Static: added as a permanent entry Voice: manually added as a Voice VLAN MVR: added via multicast VLAN registration MAC-based: manually added as MAC-based VLAN

9.4 VLAN Configuration

Use this screen to view IEEE 802.1Q VLAN parameters for the Switch. Click **Advanced Application > VLAN > VLAN Configuration** to see the following screen.

Figure 93 Advanced Application > VLAN > VLAN Configuration

VLAN Configuration		VLAN Status
Static VLAN Setup		Click Here
VLAN Port Setup		Click Here
Subnet Based VLAN Setup		Click Here
Protocol Based VLAN Setup		Click Here
Voice VLAN Setup		Click Here
MAC Based VLAN Setup		Click Here
Vendor ID Based VLAN Setup		Click Here

The following table describes the labels in the above screen.

Table 41 Advanced Application > VLAN > VLAN Configuration

LABEL	DESCRIPTION
Static VLAN Setup	Click Click Here to configure the Static VLAN for the Switch.
VLAN Port Setup	Click Click Here to configure the VLAN Port for the Switch.
Subnet Based VLAN Setup	Click Click Here to configure the Subnet Based VLAN for the Switch.

Table 41 Advanced Application > VLAN > VLAN Configuration

LABEL	DESCRIPTION
Protocol Based VLAN Setup	Click Click Here to configure the Protocol Based VLAN for the Switch.
Voice VLAN Setup	Click Click Here to configure the Voice VLAN for the Switch.
MAC Based VLAN Setup	Click Click Here to configure the MAC Based VLAN for the Switch.
Vendor ID Based VLAN Setup	Click Click Here to configure the Vendor ID Based VLAN for the Switch.

9.5 Configure a Static VLAN

Use this screen to configure a static VLAN for the Switch. Click the **Static VLAN Setup** link in the **VLAN Configuration** screen to display the screen as shown next.

Figure 94 Advanced Application > VLAN > VLAN Configuration > Static VLAN Setup

The following table describes the related labels in this screen.

Table 42 Advanced Application > VLAN > VLAN Configuration > Static VLAN Setup

LABEL	DESCRIPTION
ACTIVE	Select this check box to activate the VLAN settings.
Name	Enter a descriptive name for the VLAN group for identification purposes. This name consists of up to 64 printable characters. Spaces are allowed.
VLAN Group ID	Enter the VLAN ID for this static entry; the valid range is between 1 and 4094. Note: Do NOT add a VLAN ID that has been used in the Voice VLAN Setup .

Table 42 Advanced Application > VLAN > VLAN Configuration > Static VLAN Setup (continued)

LABEL	DESCRIPTION
*	Settings in this row apply to all ports. Use this row only if you want to make some settings the same for all ports. Use this row first to set the common settings and then make adjustments on a port-by-port basis. Note: Changes in this row are copied to all the ports as soon as you make them.
Control	Select Normal for the port to dynamically join this VLAN group using GVRP. This is the default selection. Select Fixed for the port to be a permanent member of this VLAN group. Select Forbidden if you want to prohibit the port from joining this VLAN group.
Tagging	Select TX Tagging if you want the port to tag all outgoing frames transmitted with this VLAN Group ID.
Add	Click Add to save your changes to the Switch's run-time memory. The Switch loses these changes if it is turned off or loses power, so use the Save link on the top navigation panel to save your changes to the non-volatile memory when you are done configuring.
Cancel	Click Cancel to begin configuring this screen afresh.
Clear	Click Clear to start configuring the screen again.
VID	This field displays the ID number of the VLAN group. Click the number to edit the VLAN settings.
Active	This field indicates whether the VLAN settings are enabled (Yes) or disabled (No).
Name	This field displays the descriptive name for this VLAN group.
	Select an entry's check box to select a specific entry. Otherwise, select the check box in the table heading row to select all entries.
Delete	Click Delete to remove the selected entry from the summary table.
Cancel	Click Cancel to clear the check boxes.

9.6 Configure VLAN Port Settings

Use this screen to configure the static VLAN (IEEE 802.1Q) settings on a port. Click the **VLAN Port Setup** link in the **VLAN Configuration** screen.

Figure 95 Advanced Application > VLAN > VLAN Configuration > VLAN Port Setup

Port	Ingress Check	PVID	GVRP	Acceptable Frame Type	VLAN Trunking	Isolation
*	<input type="checkbox"/>		<input type="checkbox"/>	All	<input type="checkbox"/>	<input type="checkbox"/>
1	<input type="checkbox"/>	1	<input type="checkbox"/>	All	<input type="checkbox"/>	<input type="checkbox"/>
2	<input type="checkbox"/>	1	<input type="checkbox"/>	All	<input type="checkbox"/>	<input type="checkbox"/>
3	<input type="checkbox"/>	1	<input type="checkbox"/>	All	<input type="checkbox"/>	<input type="checkbox"/>
4	<input type="checkbox"/>	1	<input type="checkbox"/>	All	<input type="checkbox"/>	<input type="checkbox"/>
5	<input type="checkbox"/>	1	<input type="checkbox"/>	All	<input type="checkbox"/>	<input type="checkbox"/>
6	<input type="checkbox"/>	1	<input type="checkbox"/>	All	<input type="checkbox"/>	<input type="checkbox"/>
7	<input type="checkbox"/>	1	<input type="checkbox"/>	All	<input type="checkbox"/>	<input type="checkbox"/>
8	<input type="checkbox"/>	1	<input type="checkbox"/>	All	<input type="checkbox"/>	<input type="checkbox"/>
9	<input type="checkbox"/>	1	<input type="checkbox"/>	All	<input type="checkbox"/>	<input type="checkbox"/>
10	<input type="checkbox"/>	1	<input type="checkbox"/>	All	<input type="checkbox"/>	<input type="checkbox"/>
11	<input type="checkbox"/>	1	<input type="checkbox"/>	All	<input type="checkbox"/>	<input type="checkbox"/>
12	<input type="checkbox"/>	1	<input type="checkbox"/>	All	<input type="checkbox"/>	<input type="checkbox"/>

The following table describes the labels in this screen.

Table 43 Advanced Application > VLAN > VLAN Configuration > VLAN Port Setup

LABEL	DESCRIPTION
GVRP	GVRP (GARP VLAN Registration Protocol) is a registration protocol that defines a way for switches to register necessary VLAN members on ports across the network. Select this check box to permit VLAN groups beyond the local Switch.
Port	This field displays the port number.
*	Settings in this row apply to all ports. Use this row only if you want to make some settings the same for all ports. Use this row first to set the common settings and then make adjustments on a port-by-port basis. Note: Changes in this row are copied to all the ports as soon as you make them.
Ingress Check	If this check box is selected, the Switch discards incoming frames on a port for VLANs that do not include this port in its member set. Clear this check box to disable ingress filtering.
PVID	A PVID (Port VLAN ID) is a tag that adds to incoming untagged frames received on a port so that the frames are forwarded to the VLAN group that the tag defines. Enter a number between 1 and 4094 as the port VLAN ID.
GVRP	Select this check box to allow GVRP on this port.
Acceptable Frame Type	Specify the type of frames allowed on a port. Choices are All , Tag Only and Untag Only . Select All from the drop-down list box to accept all untagged or tagged frames on this port. This is the default setting. Select Tag Only to accept only tagged frames on this port. All untagged frames will be dropped. Select Untag Only to accept only untagged frames on this port. All tagged frames will be dropped.

Table 43 Advanced Application > VLAN > VLAN Configuration > VLAN Port Setup (continued)

LABEL	DESCRIPTION
VLAN Trunking	Enable VLAN Trunking on ports connected to other switches or routers (but not ports directly connected to end users) to allow frames belonging to unknown VLAN groups to pass through the Switch.
Isolation	Select this to allows this port to communicate only with the CPU management port and the ports on which the isolation feature is NOT enabled.
Apply	Click Apply to save your changes to the Switch's run-time memory. The Switch loses these changes if it is turned off or loses power, so use the Save link on the top navigation panel to save your changes to the non-volatile memory when you are done configuring.
Cancel	Click Cancel to begin configuring this screen afresh.

9.7 Subnet Based VLANs

Subnet based VLANs allow you to group traffic into logical VLANs based on the source IP subnet you specify. When a frame is received on a port, the Switch checks if a tag is added already and the IP subnet it came from. The untagged packets from the same IP subnet are then placed in the same subnet based VLAN. One advantage of using subnet based VLANs is that priority can be assigned to traffic from the same IP subnet.

Note: Subnet based VLAN applies to un-tagged packets and is applicable only when you use IEEE 802.1Q tagged VLAN.

For example, an ISP (Internet Services Provider) may divide different types of services it provides to customers into different IP subnets. Traffic for voice services is designated for IP subnet 172.16.1.0/24, video for 192.168.1.0/24 and data for 10.1.1.0/24. The Switch can then be configured to group incoming traffic based on the source IP subnet of incoming frames.

You configure a subnet based VLAN with priority 6 and VID of 100 for traffic received from IP subnet 172.16.1.0/24 (voice services). You also have a subnet based VLAN with priority 5 and VID of 200 for traffic received from IP subnet 192.168.1.0/24 (video services). Lastly, you configure VLAN with priority 3 and VID of 300 for traffic received from IP subnet 10.1.1.0/24 (data services). All untagged incoming frames will be classified based on their source IP subnet and prioritized accordingly. That is video services receive the highest priority and data the lowest.

Figure 96 Subnet Based VLAN Application Example

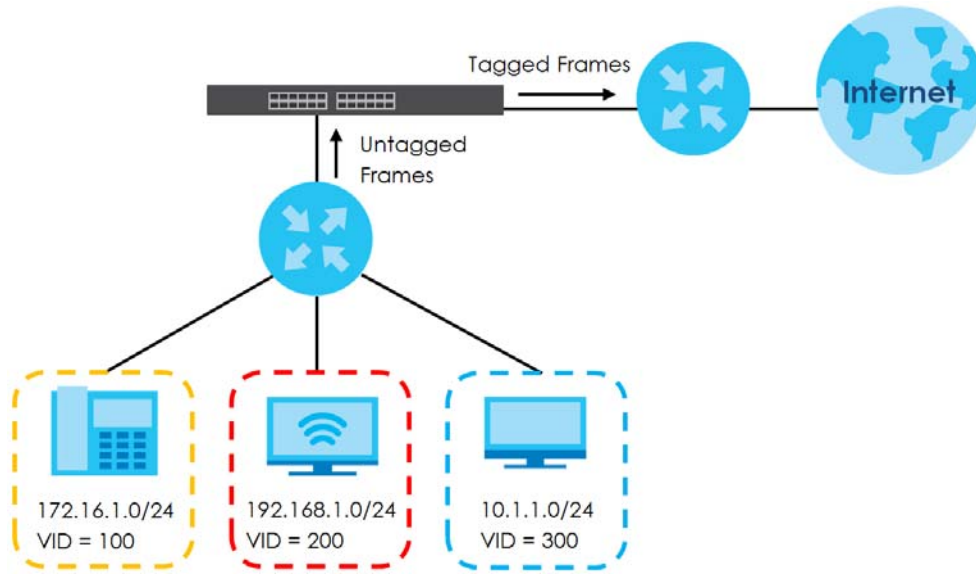

9.7.1 Configuring Subnet Based VLAN

Click the **Subnet Based VLAN Setup** link in the **VLAN Configuration** screen to display the configuration screen as shown.

Figure 97 Advanced Application > VLAN > VLAN Configuration > Subnet Based VLAN Setup

Subnet Based VLAN		VLAN Configuration					
Active	<input type="checkbox"/>						
DHCP-Vlan Override	<input type="checkbox"/>						
Apply							
Active	<input type="checkbox"/>						
Name	<input type="text"/>						
IP	<input type="text"/>						
Mask-Bits	<input type="text"/>						
VID	<input type="text"/>						
Priority	<input type="text"/>						
Add Cancel							
Index	Active	Name	IP	Mask-Bits	VID	Priority	
Delete Cancel							

The following table describes the labels in this screen.

Table 44 Advanced Application > VLAN > VLAN Configuration > Subnet Based VLAN Setup

LABEL	DESCRIPTION
Active	Check this box to activate this subnet based VLANs on the Switch.
DHCP-Vlan Override	When DHCP snooping is enabled DHCP clients can renew their IP address through the DHCP VLAN or via another DHCP server on the subnet based VLAN. Select this check box to force the DHCP clients in this IP subnet to obtain their IP addresses through the DHCP VLAN.
Apply	Click Apply to save your changes to the Switch's run-time memory. The Switch loses these changes if it is turned off or loses power, so use the Save link on the top navigation panel to save your changes to the non-volatile memory when you are done configuring.
Active	Check this box to activate the IP subnet VLAN you are creating or editing.
Name	Enter up to 32 alpha numeric characters to identify this subnet based VLAN.
IP	Enter the IP address of the subnet for which you want to configure this subnet based VLAN.
Mask-Bits	Enter the bit number of the subnet mask. To find the bit number, convert the subnet mask to binary format and add all the 1's together. Take "255.255.255.0" for example. 255 converts to eight 1s in binary. There are three 255s, so add three eights together and you get the bit number (24).
VID	Enter the ID of a VLAN with which the untagged frames from the IP subnet specified in this subnet based VLAN are tagged. This must be an existing VLAN which you defined in the Advanced Application > VLAN screens.
Priority	Select the priority level that the Switch assigns to frames belonging to this VLAN.
Add	Click this to create a new entry or to update an existing one. This saves your changes to the Switch's run-time memory. The Switch loses these changes if it is turned off or loses power, so use the Save link on the top navigation panel to save your changes to the non-volatile memory when you are done configuring.
Cancel	Click Cancel to begin configuring this screen afresh.
Index	This is the index number identifying this subnet based VLAN. Click on any of these numbers to edit an existing subnet based VLAN.
Active	This field shows whether the subnet based VLAN is active or not.
Name	This field shows the name the subnet based VLAN.
IP	This field shows the IP address of the subnet for this subnet based VLAN.
Mask-Bits	This field shows the subnet mask in bit number format for this subnet based VLAN.
VID	This field shows the VLAN ID of the frames which belong to this subnet based VLAN.
Priority	This field shows the priority which is assigned to frames belonging to this subnet based VLAN.
	Select an entry's check box to select a specific entry. Otherwise, select the check box in the table heading row to select all entries.
Delete	Click this to delete the subnet based VLANs which you marked for deletion.
Cancel	Click Cancel to clear the check boxes.

9.8 Protocol Based VLANs

Protocol based VLANs allow you to group traffic into logical VLANs based on the protocol you specify. When an upstream frame is received on a port (configured for a protocol based VLAN), the Switch checks if a tag is added already and its protocol. The untagged packets of the same protocol are then

placed in the same protocol based VLAN. One advantage of using protocol based VLANs is that priority can be assigned to traffic of the same protocol.

Note: Protocol-based VLAN applies to un-tagged packets and is applicable only when you use IEEE 802.1Q tagged VLAN.

For example, port 1, 2, 3 and 4 belong to static VLAN 100, and port 4, 5, 6, 7 belong to static VLAN 120. You configure a protocol based VLAN A with priority 3 for ARP traffic received on port 1, 2 and 3. You also have a protocol based VLAN B with priority 2 for Apple Talk traffic received on port 6 and 7. All upstream ARP traffic from port 1, 2 and 3 will be grouped together, and all upstream Apple Talk traffic from port 6 and 7 will be in another group and have higher priority than ARP traffic, when they go through the uplink port to a backbone switch C.

Figure 98 Protocol Based VLAN Application Example

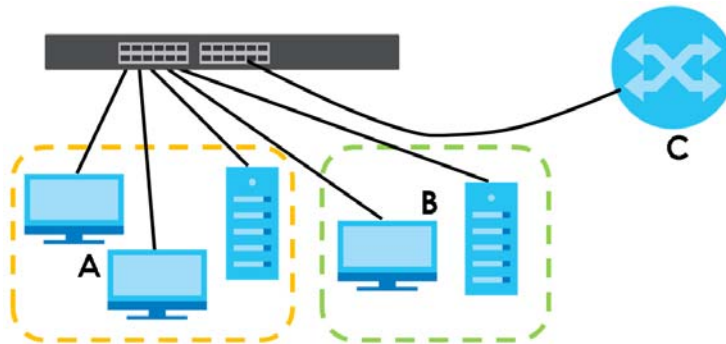

9.8.1 Configuring Protocol Based VLAN

Click the **Protocol Based VLAN Setup** link in the **VLAN Configuration** screen to display the configuration screen as shown.

Figure 99 Advanced Application > VLAN > VLAN Configuration > Protocol Based VLAN Setup

Protocol Based VLAN		VLAN Configuration					
Active	<input type="checkbox"/>						
Port	<input type="text"/>						
Name	<input type="text"/>						
Ethernet-type	<input checked="" type="radio"/> IP <input type="radio"/> Others <input type="text"/> (Hex)						
VID	<input type="text"/>						
Priority	0 ▾						
<input type="button" value="Add"/> <input type="button" value="Cancel"/>							
Index	Active	Port	Name	Ethernet-type	VID	Priority	
<input type="button" value="Delete"/> <input type="button" value="Cancel"/>							

The following table describes the labels in this screen.

Table 45 Advanced Application > VLAN > VLAN Configuration > Protocol Based VLAN Setup

LABEL	DESCRIPTION
Active	Check this box to activate this protocol based VLAN.
Port	Type a port to be included in this protocol based VLAN. This port must belong to a static VLAN in order to participate in a protocol based VLAN.
Name	Enter up to 32 alpha numeric characters to identify this protocol based VLAN.
Ethernet-type	Use the drop down list box to select a predefined protocol to be included in this protocol based VLAN or select Others and type the protocol number in hexadecimal notation. For example the IP protocol in hexadecimal notation is 0800, and Novell IPX protocol is 8137. Note: Protocols in the hexadecimal number range of 0x0000 to 0x05ff are not allowed to be used for protocol based VLANs.
VID	Enter the ID of a VLAN to which the port belongs. This must be an existing VLAN which you defined in the Advanced Application > VLAN screens.
Priority	Select the priority level that the Switch will assign to frames belonging to this VLAN.
Add	Click this to create a new entry or to update an existing one. This saves your changes to the Switch's run-time memory. The Switch loses these changes if it is turned off or loses power, so use the Save link on the top navigation panel to save your changes to the non-volatile memory when you are done configuring.
Cancel	Click Cancel to begin configuring this screen afresh.
Index	This is the index number identifying this protocol based VLAN. Click on any of these numbers to edit an existing protocol based VLAN.
Active	This field shows whether the protocol based VLAN is active or not.
Port	This field shows which port belongs to this protocol based VLAN.
Name	This field shows the name the protocol based VLAN.
Ethernet-type	This field shows which Ethernet protocol is part of this protocol based VLAN.
VID	This field shows the VLAN ID of the port.
Priority	This field shows the priority which is assigned to frames belonging to this protocol based VLAN.
	Select an entry's check box to select a specific entry. Otherwise, select the check box in the table heading row to select all entries.
Delete	Click this to delete the protocol based VLANs which you marked for deletion.
Cancel	Click Cancel to clear the check boxes.

9.9 Voice VLAN

Voice VLAN is a VLAN that is specifically allocated for voice traffic. It ensures that the sound quality of an IP phone is preserved from deteriorating when the data traffic on the Switch ports is high. It groups the voice traffic with defined priority into an assigned VLAN which enables the separation of voice and data traffic coming onto the Switch port.

The Switch can determine whether a received packet is

- an untagged voice packet when the incoming port is a fixed port for voice VLAN.
- a tagged voice packet when the incoming port and VLAN tag belongs to a voice VLAN.

It then checks the source packet's MAC address against an OUI list. If a match is found, the packet is considered as a voice packet.

You can set priority level to the Voice VLAN and add MAC address of IP phones from specific manufacturers by using its ID from the Organizationally Unique Identifiers (OUI).

Click the **Voice VLAN Setup** link in the **VLAN Configuration** screen to display the configuration screen as shown.

Figure 100 Advanced Application > VLAN > VLAN Configuration > Voice VLAN Setup

The following table describes the fields in the above screen.

Table 46 Advanced Application > VLAN > VLAN Configuration > Voice VLAN Setup

LABEL	DESCRIPTION
Voice VLAN Global Setup	
Voice VLAN	Click the second radio button if you want to enable the Voice VLAN feature. Enter a VLAN ID number that is associated with the Voice VLAN. Click the Disable radio button if you do not want to enable the Voice VLAN feature.
Priority	Select the priority level of the voice traffic from 0 to 7. Default setting is 5. The higher the numeric value you assign, the higher the priority for this voice traffic.
Apply	Click Apply to save your changes to the Switch's run-time memory. The Switch loses these changes if it is turned off or loses power, so use the Save link on the top navigation panel to save your changes to the non-volatile memory when you are done configuring.
Cancel	Click Cancel to begin configuring this section afresh.
Clear	Click Clear to reset the fields to default settings.
Voice VLAN OUI Setup	
OUI address	Enter the IP Phone manufacturer's OUI MAC address. The first 3 bytes is the manufacturer identifier, the last 3 bytes is a unique station ID.

Table 46 Advanced Application > VLAN > VLAN Configuration > Voice VLAN Setup (continued)

LABEL	DESCRIPTION
OUI mask	Enter the mask for the specified IP Phone manufacturer's OUI MAC address to determine which bits a packet's MAC address should match. Enter "f" for each bit of the specified MAC address that the traffic's MAC address should match. Enter "0" for the bits of the matched traffic's MAC address, which can be of any hexadecimal characters. For example, if you set the MAC address to 00:13:49:00:00:00 and the mask to ff:ff:ff:00:00:00, a packet with a MAC address of 00:13:49:12:34:56 matches this criteria.
Description	Enter a description up to 32 characters for the Voice VLAN device. For example: Siemens.
Add	Click Add to save your changes to the Switch's run-time memory. The Switch loses these changes if it is turned off or loses power, so use the Save link on the top navigation panel to save your changes to the non-volatile memory when you are done configuring.
Cancel	Click Cancel to begin configuring this section afresh.
Index	This field displays the index number of the Voice VLAN.
OUI address	This field displays the OUI address of the Voice VLAN.
OUI mask	This field displays the OUI mask address of the Voice VLAN.
Description	This field displays the description of the Voice VLAN with OUI address.
	Select an entry's check box to select a specific entry. Otherwise, select the check box in the table heading row to select all entries.
Delete	Click Delete to remove the selected entry from the summary table.
Cancel	Click Cancel to clear the check boxes.

9.10 MAC Based VLAN

The MAC-based VLAN feature assigns incoming untagged packets to a VLAN and classifies the traffic based on the source MAC address of the packet. When untagged packets arrive at the Switch, the source MAC address of the packet is looked up in a MAC to VLAN mapping table. If an entry is found, the corresponding VLAN ID is assigned to the packet. The assigned VLAN ID is verified against the VLAN table. If the VLAN is valid, ingress processing on the packet continues; otherwise, the packet is dropped.

This feature allows users to change ports without having to reconfigure the VLAN. You can assign priority to the MAC-based VLAN and define a MAC to VLAN mapping table by entering a specified source MAC address in the MAC-based VLAN setup screen. You can also delete a MAC-based VLAN entry in the same screen.

Click the **MAC Based VLAN Setup** link in the **VLAN Configuration** screen to see the following screen.

Figure 101 Advanced Application > VLAN > VLAN Configuration > MAC Based VLAN Setup

The following table describes the fields in the above screen.

Table 47 Advanced Application > VLAN > VLAN Configuration > MAC Based VLAN Setup

LABEL	DESCRIPTION
Name	Type a name up to 32 alpha numeric characters for the MAC-based VLAN entry.
MAC Address	Type a MAC address that is bind to the MAC-based VLAN entry. This is the source MAC address of the data packet that is looked up when untagged packets arrive at the Switch.
VID	Type an ID (from 1 to 4094) for the VLAN that is associated with the MAC-based VLAN entry.
Priority	Type a priority (0 to 7) that the Switch assigns to frames belonging to this VLAN. The higher the numeric value you assign, the higher the priority for this MAC-based VLAN entry.
Add	Click Add to save the new MAC-based VLAN entry.
Cancel	Click Cancel to clear the fields in the MAC-based VLAN entry.
Index	This field displays the index number of the MAC-based VLAN entry.
Name	This field displays the name of the MAC-based VLAN entry.
MAC Address	This field displays the source MAC address that is bind to the MAC-based VLAN entry.
VID	This field displays the VLAN ID of the MAC-based VLAN entry.
Priority	This field displays the priority level which is assigned to frames belonging to this MAC-based VLAN entity.
	Select an entry's check box to select a specific entry. Otherwise, select the check box in the table heading row to select all entries.
Delete	Click Delete to remove the selected entry from the summary table.
Cancel	Click Cancel to clear the check boxes.

9.11 Vendor ID Based VLAN

The Vendor ID based VLAN feature assigns incoming untagged packets to a VLAN and classifies the traffic based on the source MAC address of the packet. When untagged packets arrive at the switch, the source MAC address of the packet is looked up in a Vendor ID to VLAN mapping table. If an entry is found, the corresponding VLAN ID is assigned to the packet. The assigned VLAN ID is verified against the VLAN table. If the VLAN is valid, ingress processing on the packet continues; otherwise, the packet is dropped.

This feature allows users to change ports without having to reconfigure the VLAN. You can assign a 802.1p priority to the vendor ID based VLAN and define a vendor ID to VLAN mapping table by entering a specified source MAC address and mask in the vendor ID based VLAN setup screen. You can also delete a vendor ID based VLAN entry in the same screen.

For every vendor ID based VLAN rule you set, you can specify a weight number to define the rule's priority level. As rules are processed one after the other, stating a priority order will let you choose which rule has to be applied first and which second.

Click the **Vendor ID Based VLAN Setup** link in the **VLAN Configuration** screen to see the following screen.

Figure 102 Advanced Application > VLAN > VLAN Configuration > Vendor ID Based VLAN Setup

The following table describes the fields in the above screen.

Table 48 Advanced Application > VLAN > VLAN Configuration > Vendor ID Based VLAN Setup

LABEL	DESCRIPTION
Name	Type a name up to 32 alpha numeric characters for the vendor ID based VLAN entry.
MAC Address	Type a MAC address that is bind to the vendor ID-based VLAN entry. This is the source MAC address of the data packet that is looked up when untagged packets arrive at the Switch.
Mask	Type the mask for the specified source MAC address to determine which bits a packet's MAC address should match. Enter "f" for each bit of the specified MAC address that the traffic's MAC address should match. Enter "0" for the bits of the matched traffic's MAC address, which can be of any hexadecimal characters. For example, if you set the MAC address to 00:13:49:00:00:00 and the mask to ff:ff:ff:00:00:00, a packet with a MAC address of 00:13:49:12:34:56 matches this criteria.
VLAN	Type an ID (from 1 to 4094) for the VLAN that is associated with the vendor ID based VLAN entry.
Priority	Select the priority level that the Switch assigns to frames belonging to this VLAN. The higher the numeric value you assign, the higher the priority for this vendor ID based VLAN entry.
Weight	Enter a number between 0 and 255 to specify the rule's weight. This is to decide the priority in which the rule is applied. The higher the number, the higher the rule's priority.
Add	Click Add to save the new vendor ID based VLAN entry.
Cancel	Click Cancel to clear the fields in the vendor ID based VLAN entry.
Index	This field displays the index number of the vendor ID based VLAN entry.

Table 48 Advanced Application > VLAN > VLAN Configuration > Vendor ID Based VLAN Setup

LABEL	DESCRIPTION
Name	This field displays the name of the vendor ID based VLAN entry.
MAC Address	This field displays the source MAC address that is bind to the vendor ID based VLAN entry.
Mask	This field displays the mask for the source MAC address that is bind to the vendor ID based VLAN entry.
VLAN	This field displays the VLAN ID of the vendor ID based VLAN entry.
Priority	This field displays the priority level which is assigned to frames belonging to this vendor ID based VLAN.
Weight	This field displays the weight of the vendor ID based VLAN entry.
	Select an entry's check box to select a specific entry. Otherwise, select the check box in the table heading row to select all entries.
Delete	Click Delete to remove the selected entry from the summary table.
Cancel	Click Cancel to clear the check boxes.

9.12 Port-Based VLAN Setup

Port-based VLANs are VLANs where the packet forwarding decision is based on the destination MAC address and its associated port.

Port-based VLANs require allowed outgoing ports to be defined for each port. Therefore, if you wish to allow two subscriber ports to talk to each other, for example, between conference rooms in a hotel, you must define the egress (an egress port is an outgoing port, that is, a port through which a data packet leaves) for both ports.

Port-based VLANs are specific only to the Switch on which they were created.

Note: When you activate port-based VLAN, the Switch uses a default VLAN ID of 1. You cannot change it.

Note: In screens (such as **IP Setup** and **Filtering**) that require a VID, you must enter 1 as the VID.

The port-based VLAN setup screen is shown next. The **CPU** management port forms a VLAN with all Ethernet ports.

9.12.1 Configure a Port-Based VLAN

Select **Port Based** as the VLAN Type in the **Basic Setting > Switch Setup** screen and then click **Advanced Application > VLAN** from the navigation panel to display the next screen.

Figure 104 Advanced Application > VLAN: Port Based VLAN Setup (Port Isolation)

Port Based VLAN Setup

Setting Wizard: Port Isolation [Apply]

	1	2	3	4	5	6	7	8	9	10	11	12	13	14	15	16	17	18	19	20	21	22	23	24	25	Innc	47	48	49	50	
1	<input checked="" type="checkbox"/>	<input type="checkbox"/>	<input type="checkbox"/>	<input type="checkbox"/>	<input type="checkbox"/>	<input type="checkbox"/>	<input type="checkbox"/>	<input type="checkbox"/>	<input type="checkbox"/>	<input type="checkbox"/>	<input type="checkbox"/>	<input type="checkbox"/>	<input type="checkbox"/>	<input type="checkbox"/>	<input type="checkbox"/>	<input type="checkbox"/>	<input type="checkbox"/>	<input type="checkbox"/>	<input type="checkbox"/>	<input type="checkbox"/>	<input type="checkbox"/>	<input type="checkbox"/>	<input type="checkbox"/>	<input type="checkbox"/>	<input type="checkbox"/>	<input type="checkbox"/>	<input type="checkbox"/>	<input type="checkbox"/>	<input type="checkbox"/>	1	
2	<input type="checkbox"/>	<input checked="" type="checkbox"/>	<input type="checkbox"/>	<input type="checkbox"/>	<input type="checkbox"/>	<input type="checkbox"/>	<input type="checkbox"/>	<input type="checkbox"/>	<input type="checkbox"/>	<input type="checkbox"/>	<input type="checkbox"/>	<input type="checkbox"/>	<input type="checkbox"/>	<input type="checkbox"/>	<input type="checkbox"/>	<input type="checkbox"/>	<input type="checkbox"/>	<input type="checkbox"/>	<input type="checkbox"/>	<input type="checkbox"/>	<input type="checkbox"/>	<input type="checkbox"/>	<input type="checkbox"/>	<input type="checkbox"/>	<input type="checkbox"/>	<input type="checkbox"/>	<input type="checkbox"/>	<input type="checkbox"/>	2		
3	<input type="checkbox"/>	<input type="checkbox"/>	<input checked="" type="checkbox"/>	<input type="checkbox"/>	<input type="checkbox"/>	<input type="checkbox"/>	<input type="checkbox"/>	<input type="checkbox"/>	<input type="checkbox"/>	<input type="checkbox"/>	<input type="checkbox"/>	<input type="checkbox"/>	<input type="checkbox"/>	<input type="checkbox"/>	<input type="checkbox"/>	<input type="checkbox"/>	<input type="checkbox"/>	<input type="checkbox"/>	<input type="checkbox"/>	<input type="checkbox"/>	<input type="checkbox"/>	<input type="checkbox"/>	<input type="checkbox"/>	<input type="checkbox"/>	<input type="checkbox"/>	<input type="checkbox"/>	<input type="checkbox"/>	<input type="checkbox"/>	3		
4	<input type="checkbox"/>	<input type="checkbox"/>	<input type="checkbox"/>	<input checked="" type="checkbox"/>	<input type="checkbox"/>	<input type="checkbox"/>	<input type="checkbox"/>	<input type="checkbox"/>	<input type="checkbox"/>	<input type="checkbox"/>	<input type="checkbox"/>	<input type="checkbox"/>	<input type="checkbox"/>	<input type="checkbox"/>	<input type="checkbox"/>	<input type="checkbox"/>	<input type="checkbox"/>	<input type="checkbox"/>	<input type="checkbox"/>	<input type="checkbox"/>	<input type="checkbox"/>	<input type="checkbox"/>	<input type="checkbox"/>	<input type="checkbox"/>	<input type="checkbox"/>	<input type="checkbox"/>	<input type="checkbox"/>	<input type="checkbox"/>	4		
5	<input type="checkbox"/>	<input type="checkbox"/>	<input type="checkbox"/>	<input type="checkbox"/>	<input checked="" type="checkbox"/>	<input type="checkbox"/>	<input type="checkbox"/>	<input type="checkbox"/>	<input type="checkbox"/>	<input type="checkbox"/>	<input type="checkbox"/>	<input type="checkbox"/>	<input type="checkbox"/>	<input type="checkbox"/>	<input type="checkbox"/>	<input type="checkbox"/>	<input type="checkbox"/>	<input type="checkbox"/>	<input type="checkbox"/>	<input type="checkbox"/>	<input type="checkbox"/>	<input type="checkbox"/>	<input type="checkbox"/>	<input type="checkbox"/>	<input type="checkbox"/>	<input type="checkbox"/>	<input type="checkbox"/>	<input type="checkbox"/>	5		
6	<input type="checkbox"/>	<input type="checkbox"/>	<input type="checkbox"/>	<input type="checkbox"/>	<input type="checkbox"/>	<input checked="" type="checkbox"/>	<input type="checkbox"/>	<input type="checkbox"/>	<input type="checkbox"/>	<input type="checkbox"/>	<input type="checkbox"/>	<input type="checkbox"/>	<input type="checkbox"/>	<input type="checkbox"/>	<input type="checkbox"/>	<input type="checkbox"/>	<input type="checkbox"/>	<input type="checkbox"/>	<input type="checkbox"/>	<input type="checkbox"/>	<input type="checkbox"/>	<input type="checkbox"/>	<input type="checkbox"/>	<input type="checkbox"/>	<input type="checkbox"/>	<input type="checkbox"/>	<input type="checkbox"/>	<input type="checkbox"/>	6		
7	<input type="checkbox"/>	<input type="checkbox"/>	<input type="checkbox"/>	<input type="checkbox"/>	<input type="checkbox"/>	<input type="checkbox"/>	<input checked="" type="checkbox"/>	<input type="checkbox"/>	<input type="checkbox"/>	<input type="checkbox"/>	<input type="checkbox"/>	<input type="checkbox"/>	<input type="checkbox"/>	<input type="checkbox"/>	<input type="checkbox"/>	<input type="checkbox"/>	<input type="checkbox"/>	<input type="checkbox"/>	<input type="checkbox"/>	<input type="checkbox"/>	<input type="checkbox"/>	<input type="checkbox"/>	<input type="checkbox"/>	<input type="checkbox"/>	<input type="checkbox"/>	<input type="checkbox"/>	<input type="checkbox"/>	<input type="checkbox"/>	7		
8	<input type="checkbox"/>	<input type="checkbox"/>	<input type="checkbox"/>	<input type="checkbox"/>	<input type="checkbox"/>	<input type="checkbox"/>	<input type="checkbox"/>	<input checked="" type="checkbox"/>	<input type="checkbox"/>	<input type="checkbox"/>	<input type="checkbox"/>	<input type="checkbox"/>	<input type="checkbox"/>	<input type="checkbox"/>	<input type="checkbox"/>	<input type="checkbox"/>	<input type="checkbox"/>	<input type="checkbox"/>	<input type="checkbox"/>	<input type="checkbox"/>	<input type="checkbox"/>	<input type="checkbox"/>	<input type="checkbox"/>	<input type="checkbox"/>	<input type="checkbox"/>	<input type="checkbox"/>	<input type="checkbox"/>	<input type="checkbox"/>	8		
9	<input type="checkbox"/>	<input type="checkbox"/>	<input type="checkbox"/>	<input type="checkbox"/>	<input type="checkbox"/>	<input type="checkbox"/>	<input type="checkbox"/>	<input type="checkbox"/>	<input checked="" type="checkbox"/>	<input type="checkbox"/>	<input type="checkbox"/>	<input type="checkbox"/>	<input type="checkbox"/>	<input type="checkbox"/>	<input type="checkbox"/>	<input type="checkbox"/>	<input type="checkbox"/>	<input type="checkbox"/>	<input type="checkbox"/>	<input type="checkbox"/>	<input type="checkbox"/>	<input type="checkbox"/>	<input type="checkbox"/>	<input type="checkbox"/>	<input type="checkbox"/>	<input type="checkbox"/>	<input type="checkbox"/>	<input type="checkbox"/>	9		
10	<input type="checkbox"/>	<input type="checkbox"/>	<input type="checkbox"/>	<input type="checkbox"/>	<input type="checkbox"/>	<input type="checkbox"/>	<input type="checkbox"/>	<input type="checkbox"/>	<input type="checkbox"/>	<input checked="" type="checkbox"/>	<input type="checkbox"/>	<input type="checkbox"/>	<input type="checkbox"/>	<input type="checkbox"/>	<input type="checkbox"/>	<input type="checkbox"/>	<input type="checkbox"/>	<input type="checkbox"/>	<input type="checkbox"/>	<input type="checkbox"/>	<input type="checkbox"/>	<input type="checkbox"/>	<input type="checkbox"/>	<input type="checkbox"/>	<input type="checkbox"/>	<input type="checkbox"/>	<input type="checkbox"/>	<input type="checkbox"/>	10		
11	<input type="checkbox"/>	<input type="checkbox"/>	<input type="checkbox"/>	<input type="checkbox"/>	<input type="checkbox"/>	<input type="checkbox"/>	<input type="checkbox"/>	<input type="checkbox"/>	<input type="checkbox"/>	<input type="checkbox"/>	<input checked="" type="checkbox"/>	<input type="checkbox"/>	<input type="checkbox"/>	<input type="checkbox"/>	<input type="checkbox"/>	<input type="checkbox"/>	<input type="checkbox"/>	<input type="checkbox"/>	<input type="checkbox"/>	<input type="checkbox"/>	<input type="checkbox"/>	<input type="checkbox"/>	<input type="checkbox"/>	<input type="checkbox"/>	<input type="checkbox"/>	<input type="checkbox"/>	<input type="checkbox"/>	<input type="checkbox"/>	11		
12	<input type="checkbox"/>	<input type="checkbox"/>	<input type="checkbox"/>	<input type="checkbox"/>	<input type="checkbox"/>	<input type="checkbox"/>	<input type="checkbox"/>	<input type="checkbox"/>	<input type="checkbox"/>	<input type="checkbox"/>	<input type="checkbox"/>	<input checked="" type="checkbox"/>	<input type="checkbox"/>	<input type="checkbox"/>	<input type="checkbox"/>	<input type="checkbox"/>	<input type="checkbox"/>	<input type="checkbox"/>	<input type="checkbox"/>	<input type="checkbox"/>	<input type="checkbox"/>	<input type="checkbox"/>	<input type="checkbox"/>	<input type="checkbox"/>	<input type="checkbox"/>	<input type="checkbox"/>	<input type="checkbox"/>	<input type="checkbox"/>	12		
13	<input type="checkbox"/>	<input type="checkbox"/>	<input type="checkbox"/>	<input type="checkbox"/>	<input type="checkbox"/>	<input type="checkbox"/>	<input type="checkbox"/>	<input type="checkbox"/>	<input type="checkbox"/>	<input type="checkbox"/>	<input type="checkbox"/>	<input type="checkbox"/>	<input checked="" type="checkbox"/>	<input type="checkbox"/>	<input type="checkbox"/>	<input type="checkbox"/>	<input type="checkbox"/>	<input type="checkbox"/>	<input type="checkbox"/>	<input type="checkbox"/>	<input type="checkbox"/>	<input type="checkbox"/>	<input type="checkbox"/>	<input type="checkbox"/>	<input type="checkbox"/>	<input type="checkbox"/>	<input type="checkbox"/>	<input type="checkbox"/>	13		
14	<input type="checkbox"/>	<input type="checkbox"/>	<input type="checkbox"/>	<input type="checkbox"/>	<input type="checkbox"/>	<input type="checkbox"/>	<input type="checkbox"/>	<input type="checkbox"/>	<input type="checkbox"/>	<input type="checkbox"/>	<input type="checkbox"/>	<input type="checkbox"/>	<input type="checkbox"/>	<input checked="" type="checkbox"/>	<input type="checkbox"/>	<input type="checkbox"/>	<input type="checkbox"/>	<input type="checkbox"/>	<input type="checkbox"/>	<input type="checkbox"/>	<input type="checkbox"/>	<input type="checkbox"/>	<input type="checkbox"/>	<input type="checkbox"/>	<input type="checkbox"/>	<input type="checkbox"/>	<input type="checkbox"/>	<input type="checkbox"/>	14		
15	<input type="checkbox"/>	<input type="checkbox"/>	<input type="checkbox"/>	<input type="checkbox"/>	<input type="checkbox"/>	<input type="checkbox"/>	<input type="checkbox"/>	<input type="checkbox"/>	<input type="checkbox"/>	<input type="checkbox"/>	<input type="checkbox"/>	<input type="checkbox"/>	<input type="checkbox"/>	<input type="checkbox"/>	<input checked="" type="checkbox"/>	<input type="checkbox"/>	<input type="checkbox"/>	<input type="checkbox"/>	<input type="checkbox"/>	<input type="checkbox"/>	<input type="checkbox"/>	<input type="checkbox"/>	<input type="checkbox"/>	<input type="checkbox"/>	<input type="checkbox"/>	<input type="checkbox"/>	<input type="checkbox"/>	<input type="checkbox"/>	15		
16	<input type="checkbox"/>	<input type="checkbox"/>	<input type="checkbox"/>	<input type="checkbox"/>	<input type="checkbox"/>	<input type="checkbox"/>	<input type="checkbox"/>	<input type="checkbox"/>	<input type="checkbox"/>	<input type="checkbox"/>	<input type="checkbox"/>	<input type="checkbox"/>	<input type="checkbox"/>	<input type="checkbox"/>	<input type="checkbox"/>	<input checked="" type="checkbox"/>	<input type="checkbox"/>	<input type="checkbox"/>	<input type="checkbox"/>	<input type="checkbox"/>	<input type="checkbox"/>	<input type="checkbox"/>	<input type="checkbox"/>	<input type="checkbox"/>	<input type="checkbox"/>	<input type="checkbox"/>	<input type="checkbox"/>	<input type="checkbox"/>	16		
17	<input type="checkbox"/>	<input type="checkbox"/>	<input type="checkbox"/>	<input type="checkbox"/>	<input type="checkbox"/>	<input type="checkbox"/>	<input type="checkbox"/>	<input type="checkbox"/>	<input type="checkbox"/>	<input type="checkbox"/>	<input type="checkbox"/>	<input type="checkbox"/>	<input type="checkbox"/>	<input type="checkbox"/>	<input type="checkbox"/>	<input type="checkbox"/>	<input checked="" type="checkbox"/>	<input type="checkbox"/>	<input type="checkbox"/>	<input type="checkbox"/>	<input type="checkbox"/>	<input type="checkbox"/>	<input type="checkbox"/>	<input type="checkbox"/>	<input type="checkbox"/>	<input type="checkbox"/>	<input type="checkbox"/>	<input type="checkbox"/>	17		
18	<input type="checkbox"/>	<input type="checkbox"/>	<input type="checkbox"/>	<input type="checkbox"/>	<input type="checkbox"/>	<input type="checkbox"/>	<input type="checkbox"/>	<input type="checkbox"/>	<input type="checkbox"/>	<input type="checkbox"/>	<input type="checkbox"/>	<input type="checkbox"/>	<input type="checkbox"/>	<input type="checkbox"/>	<input type="checkbox"/>	<input type="checkbox"/>	<input type="checkbox"/>	<input checked="" type="checkbox"/>	<input type="checkbox"/>	<input type="checkbox"/>	<input type="checkbox"/>	<input type="checkbox"/>	<input type="checkbox"/>	<input type="checkbox"/>	<input type="checkbox"/>	<input type="checkbox"/>	<input type="checkbox"/>	<input type="checkbox"/>	18		
19	<input type="checkbox"/>	<input type="checkbox"/>	<input type="checkbox"/>	<input type="checkbox"/>	<input type="checkbox"/>	<input type="checkbox"/>	<input type="checkbox"/>	<input type="checkbox"/>	<input type="checkbox"/>	<input type="checkbox"/>	<input type="checkbox"/>	<input type="checkbox"/>	<input type="checkbox"/>	<input type="checkbox"/>	<input type="checkbox"/>	<input type="checkbox"/>	<input type="checkbox"/>	<input type="checkbox"/>	<input checked="" type="checkbox"/>	<input type="checkbox"/>	<input type="checkbox"/>	<input type="checkbox"/>	<input type="checkbox"/>	<input type="checkbox"/>	<input type="checkbox"/>	<input type="checkbox"/>	<input type="checkbox"/>	<input type="checkbox"/>	19		
20	<input type="checkbox"/>	<input type="checkbox"/>	<input type="checkbox"/>	<input type="checkbox"/>	<input type="checkbox"/>	<input type="checkbox"/>	<input type="checkbox"/>	<input type="checkbox"/>	<input type="checkbox"/>	<input type="checkbox"/>	<input type="checkbox"/>	<input type="checkbox"/>	<input type="checkbox"/>	<input type="checkbox"/>	<input type="checkbox"/>	<input type="checkbox"/>	<input type="checkbox"/>	<input type="checkbox"/>	<input type="checkbox"/>	<input checked="" type="checkbox"/>	<input type="checkbox"/>	<input type="checkbox"/>	<input type="checkbox"/>	<input type="checkbox"/>	<input type="checkbox"/>	<input type="checkbox"/>	<input type="checkbox"/>	<input type="checkbox"/>	20		
21	<input type="checkbox"/>	<input type="checkbox"/>	<input type="checkbox"/>	<input type="checkbox"/>	<input type="checkbox"/>	<input type="checkbox"/>	<input type="checkbox"/>	<input type="checkbox"/>	<input type="checkbox"/>	<input type="checkbox"/>	<input type="checkbox"/>	<input type="checkbox"/>	<input type="checkbox"/>	<input type="checkbox"/>	<input type="checkbox"/>	<input type="checkbox"/>	<input type="checkbox"/>	<input type="checkbox"/>	<input type="checkbox"/>	<input type="checkbox"/>	<input checked="" type="checkbox"/>	<input type="checkbox"/>	<input type="checkbox"/>	<input type="checkbox"/>	<input type="checkbox"/>	<input type="checkbox"/>	<input type="checkbox"/>	<input type="checkbox"/>	21		
22	<input type="checkbox"/>	<input type="checkbox"/>	<input type="checkbox"/>	<input type="checkbox"/>	<input type="checkbox"/>	<input type="checkbox"/>	<input type="checkbox"/>	<input type="checkbox"/>	<input type="checkbox"/>	<input type="checkbox"/>	<input type="checkbox"/>	<input type="checkbox"/>	<input type="checkbox"/>	<input type="checkbox"/>	<input type="checkbox"/>	<input type="checkbox"/>	<input type="checkbox"/>	<input type="checkbox"/>	<input type="checkbox"/>	<input type="checkbox"/>	<input type="checkbox"/>	<input checked="" type="checkbox"/>	<input type="checkbox"/>	<input type="checkbox"/>	<input type="checkbox"/>	<input type="checkbox"/>	<input type="checkbox"/>	<input type="checkbox"/>	22		
23	<input type="checkbox"/>	<input type="checkbox"/>	<input type="checkbox"/>	<input type="checkbox"/>	<input type="checkbox"/>	<input type="checkbox"/>	<input type="checkbox"/>	<input type="checkbox"/>	<input type="checkbox"/>	<input type="checkbox"/>	<input type="checkbox"/>	<input type="checkbox"/>	<input type="checkbox"/>	<input type="checkbox"/>	<input type="checkbox"/>	<input type="checkbox"/>	<input type="checkbox"/>	<input type="checkbox"/>	<input type="checkbox"/>	<input type="checkbox"/>	<input type="checkbox"/>	<input type="checkbox"/>	<input checked="" type="checkbox"/>	<input type="checkbox"/>	<input type="checkbox"/>	<input type="checkbox"/>	<input type="checkbox"/>	<input type="checkbox"/>	23		
24	<input type="checkbox"/>	<input type="checkbox"/>	<input type="checkbox"/>	<input type="checkbox"/>	<input type="checkbox"/>	<input type="checkbox"/>	<input type="checkbox"/>	<input type="checkbox"/>	<input type="checkbox"/>	<input type="checkbox"/>	<input type="checkbox"/>	<input type="checkbox"/>	<input type="checkbox"/>	<input type="checkbox"/>	<input type="checkbox"/>	<input type="checkbox"/>	<input type="checkbox"/>	<input type="checkbox"/>	<input type="checkbox"/>	<input type="checkbox"/>	<input type="checkbox"/>	<input type="checkbox"/>	<input type="checkbox"/>	<input checked="" type="checkbox"/>	<input type="checkbox"/>	<input type="checkbox"/>	<input type="checkbox"/>	<input type="checkbox"/>	24		
25	<input type="checkbox"/>	<input type="checkbox"/>	<input type="checkbox"/>	<input type="checkbox"/>	<input type="checkbox"/>	<input type="checkbox"/>	<input type="checkbox"/>	<input type="checkbox"/>	<input type="checkbox"/>	<input type="checkbox"/>	<input type="checkbox"/>	<input type="checkbox"/>	<input type="checkbox"/>	<input type="checkbox"/>	<input type="checkbox"/>	<input type="checkbox"/>	<input type="checkbox"/>	<input type="checkbox"/>	<input type="checkbox"/>	<input type="checkbox"/>	<input type="checkbox"/>	<input type="checkbox"/>	<input type="checkbox"/>	<input type="checkbox"/>	<input checked="" type="checkbox"/>	<input type="checkbox"/>	<input type="checkbox"/>	<input type="checkbox"/>	25		
26	<input type="checkbox"/>	<input type="checkbox"/>	<input type="checkbox"/>	<input type="checkbox"/>	<input type="checkbox"/>	<input type="checkbox"/>	<input type="checkbox"/>	<input type="checkbox"/>	<input type="checkbox"/>	<input type="checkbox"/>	<input type="checkbox"/>	<input type="checkbox"/>	<input type="checkbox"/>	<input type="checkbox"/>	<input type="checkbox"/>	<input type="checkbox"/>	<input type="checkbox"/>	<input type="checkbox"/>	<input type="checkbox"/>	<input type="checkbox"/>	<input type="checkbox"/>	<input type="checkbox"/>	<input type="checkbox"/>	<input type="checkbox"/>	<input type="checkbox"/>	<input checked="" type="checkbox"/>	<input type="checkbox"/>	<input type="checkbox"/>	26		
27	<input type="checkbox"/>	<input type="checkbox"/>	<input type="checkbox"/>	<input type="checkbox"/>	<input type="checkbox"/>	<input type="checkbox"/>	<input type="checkbox"/>	<input type="checkbox"/>	<input type="checkbox"/>	<input type="checkbox"/>	<input type="checkbox"/>	<input type="checkbox"/>	<input type="checkbox"/>	<input type="checkbox"/>	<input type="checkbox"/>	<input type="checkbox"/>	<input type="checkbox"/>	<input type="checkbox"/>	<input type="checkbox"/>	<input type="checkbox"/>	<input type="checkbox"/>	<input type="checkbox"/>	<input type="checkbox"/>	<input type="checkbox"/>	<input type="checkbox"/>	<input type="checkbox"/>	<input type="checkbox"/>	<input type="checkbox"/>	27		
28	<input type="checkbox"/>	<input type="checkbox"/>	<input type="checkbox"/>	<input type="checkbox"/>	<input type="checkbox"/>	<input type="checkbox"/>	<input type="checkbox"/>	<input type="checkbox"/>	<input type="checkbox"/>	<input type="checkbox"/>	<input type="checkbox"/>	<input type="checkbox"/>	<input type="checkbox"/>	<input type="checkbox"/>	<input type="checkbox"/>	<input type="checkbox"/>	<input type="checkbox"/>	<input type="checkbox"/>	<input type="checkbox"/>	<input type="checkbox"/>	<input type="checkbox"/>	<input type="checkbox"/>	<input type="checkbox"/>	<input type="checkbox"/>	<input type="checkbox"/>	<input type="checkbox"/>	<input type="checkbox"/>	<input type="checkbox"/>	28		
29	<input type="checkbox"/>	<input type="checkbox"/>	<input type="checkbox"/>	<input type="checkbox"/>	<input type="checkbox"/>	<input type="checkbox"/>	<input type="checkbox"/>	<input type="checkbox"/>	<input type="checkbox"/>	<input type="checkbox"/>	<input type="checkbox"/>	<input type="checkbox"/>	<input type="checkbox"/>	<input type="checkbox"/>	<input type="checkbox"/>	<input type="checkbox"/>	<input type="checkbox"/>	<input type="checkbox"/>	<input type="checkbox"/>	<input type="checkbox"/>	<input type="checkbox"/>	<input type="checkbox"/>	<input type="checkbox"/>	<input type="checkbox"/>	<input type="checkbox"/>	<input type="checkbox"/>	<input type="checkbox"/>	<input type="checkbox"/>	29		
30	<input type="checkbox"/>	<input type="checkbox"/>	<input type="checkbox"/>	<input type="checkbox"/>	<input type="checkbox"/>	<input type="checkbox"/>	<input type="checkbox"/>	<input type="checkbox"/>	<input type="checkbox"/>	<input type="checkbox"/>	<input type="checkbox"/>	<input type="checkbox"/>	<input type="checkbox"/>	<input type="checkbox"/>	<input type="checkbox"/>	<input type="checkbox"/>	<input type="checkbox"/>	<input type="checkbox"/>	<input type="checkbox"/>	<input type="checkbox"/>	<input type="checkbox"/>	<input type="checkbox"/>	<input type="checkbox"/>	<input type="checkbox"/>	<input type="checkbox"/>	<input type="checkbox"/>	<input type="checkbox"/>	<input type="checkbox"/>	30		
31	<input type="checkbox"/>	<input type="checkbox"/>	<input type="checkbox"/>	<input type="checkbox"/>	<input type="checkbox"/>	<input type="checkbox"/>	<input type="checkbox"/>	<input type="checkbox"/>	<input type="checkbox"/>	<input type="checkbox"/>	<input type="checkbox"/>	<input type="checkbox"/>	<input type="checkbox"/>	<input type="checkbox"/>	<input type="checkbox"/>	<input type="checkbox"/>	<input type="checkbox"/>	<input type="checkbox"/>	<input type="checkbox"/>	<input type="checkbox"/>	<input type="checkbox"/>	<input type="checkbox"/>	<input type="checkbox"/>	<input type="checkbox"/>	<input type="checkbox"/>	<input type="checkbox"/>	<input type="checkbox"/>	<input type="checkbox"/>	31		
32	<input type="checkbox"/>	<input type="checkbox"/>	<input type="checkbox"/>	<input type="checkbox"/>	<input type="checkbox"/>	<input type="checkbox"/>	<input type="checkbox"/>	<input type="checkbox"/>	<input type="checkbox"/>	<input type="checkbox"/>	<input type="checkbox"/>	<input type="checkbox"/>	<input type="checkbox"/>	<input type="checkbox"/>	<input type="checkbox"/>	<input type="checkbox"/>	<input type="checkbox"/>	<input type="checkbox"/>	<input type="checkbox"/>	<input type="checkbox"/>	<input type="checkbox"/>	<input type="checkbox"/>	<input type="checkbox"/>	<input type="checkbox"/>	<input type="checkbox"/>	<input type="checkbox"/>	<input type="checkbox"/>	<input type="checkbox"/>	32		
33	<input type="checkbox"/>	<input type="checkbox"/>	<input type="checkbox"/>	<input type="checkbox"/>	<input type="checkbox"/>	<input type="checkbox"/>	<input type="checkbox"/>	<input type="checkbox"/>	<input type="checkbox"/>	<input type="checkbox"/>	<input type="checkbox"/>	<input type="checkbox"/>	<input type="checkbox"/>	<input type="checkbox"/>	<input type="checkbox"/>	<input type="checkbox"/>	<input type="checkbox"/>	<input type="checkbox"/>	<input type="checkbox"/>	<input type="checkbox"/>	<input type="checkbox"/>	<input type="checkbox"/>	<input type="checkbox"/>	<input type="checkbox"/>	<input type="checkbox"/>	<input type="checkbox"/>	<input type="checkbox"/>	<input type="checkbox"/>	33		
34	<input type="checkbox"/>	<input type="checkbox"/>	<input type="checkbox"/>	<input type="checkbox"/>	<input type="checkbox"/>	<input type="checkbox"/>	<input type="checkbox"/>	<input type="checkbox"/>	<input type="checkbox"/>	<input type="checkbox"/>	<input type="checkbox"/>	<input type="checkbox"/>	<input type="checkbox"/>	<input type="checkbox"/>	<input type="checkbox"/>	<input type="checkbox"/>	<input type="checkbox"/>	<input type="checkbox"/>	<input type="checkbox"/>	<input type="checkbox"/>	<input type="checkbox"/>	<input type="checkbox"/>	<input type="checkbox"/>	<input type="checkbox"/>	<input type="checkbox"/>	<input type="checkbox"/>	<input type="checkbox"/>	<input type="checkbox"/>	34		
35	<input type="checkbox"/>	<input type="checkbox"/>	<input type="checkbox"/>	<input type="checkbox"/>	<input type="checkbox"/>	<input type="checkbox"/>	<input type="checkbox"/>	<input type="checkbox"/>	<input type="checkbox"/>	<input type="checkbox"/>	<input type="checkbox"/>	<input type="checkbox"/>	<input type="checkbox"/>	<input type="checkbox"/>	<input type="checkbox"/>	<input type="checkbox"/>	<input type="checkbox"/>	<input type="checkbox"/>	<input type="checkbox"/>	<input type="checkbox"/>	<input type="checkbox"/>	<input type="checkbox"/>	<input type="checkbox"/>	<input type="checkbox"/>	<input type="checkbox"/>	<input type="checkbox"/>	<input type="checkbox"/>	<input type="checkbox"/>	35		
36	<input type="checkbox"/>	<input type="checkbox"/>	<input type="checkbox"/>	<input type="checkbox"/>	<input type="checkbox"/>	<input type="checkbox"/>	<input type="checkbox"/>	<input type="checkbox"/>	<input type="checkbox"/>	<input type="checkbox"/>	<input type="checkbox"/>	<input type="checkbox"/>	<input type="checkbox"/>	<input type="checkbox"/>	<input type="checkbox"/>	<input type="checkbox"/>	<input type="checkbox"/>	<input type="checkbox"/>	<input type="checkbox"/>	<input type="checkbox"/>	<input type="checkbox"/>	<input type="checkbox"/>	<input type="checkbox"/>	<input type="checkbox"/>	<input type="checkbox"/>	<input type="checkbox"/>	<input type="checkbox"/>	<input type="checkbox"/>	36		
37	<input type="checkbox"/>	<input type="checkbox"/>	<input type="checkbox"/>	<input type="checkbox"/>	<input type="checkbox"/>	<input type="checkbox"/>	<input type="checkbox"/>	<input type="checkbox"/>	<input type="checkbox"/>	<input type="checkbox"/>	<input type="checkbox"/>	<input type="checkbox"/>	<input type="checkbox"/>	<input type="checkbox"/>	<input type="checkbox"/>	<input type="checkbox"/>	<input type="checkbox"/>	<input type="checkbox"/>	<input type="checkbox"/>	<input type="checkbox"/>	<input type="checkbox"/>	<input type="checkbox"/>	<input type="checkbox"/>	<input type="checkbox"/>	<input type="checkbox"/>	<input type="checkbox"/>	<input type="checkbox"/>	<input type="checkbox"/>	37		
38	<input type="checkbox"/>	<input type="checkbox"/>	<input type="checkbox"/>	<input type="checkbox"/>	<input type="checkbox"/>	<input type="checkbox"/>	<input type="checkbox"/>	<input type="checkbox"/>	<input type="checkbox"/>	<input type="checkbox"/>	<input type="checkbox"/>	<input type="checkbox"/>	<input type="checkbox"/>	<input type="checkbox"/>	<input type="checkbox"/>	<input type="checkbox"/>	<input type="checkbox"/>	<input type="checkbox"/>	<input type="checkbox"/>	<input type="checkbox"/>	<input type="checkbox"/>	<input type="checkbox"/>	<input type="checkbox"/>	<input type="checkbox"/>	<input type="checkbox"/>	<input type="checkbox"/>	<input type="checkbox"/>	<input type="checkbox"/>	38		
39	<input type="checkbox"/>	<input type="checkbox"/>	<input type="checkbox"/>	<input type="checkbox"/>	<input type="checkbox"/>	<input type="checkbox"/>	<input type="checkbox"/>	<input type="checkbox"/>	<input type="checkbox"/>	<input type="checkbox"/>	<input type="checkbox"/>	<input type="checkbox"/>	<input type="checkbox"/>	<input type="checkbox"/>	<input type="checkbox"/>	<input type="checkbox"/>	<input type="checkbox"/>	<input type="checkbox"/>	<input type="checkbox"/>	<input type="checkbox"/>	<input type="checkbox"/>	<input type="checkbox"/>	<input type="checkbox"/>	<input type="checkbox"/>	<input type="checkbox"/>	<input type="checkbox"/>	<input type="checkbox"/>	<input type="checkbox"/>	39		
40	<input type="checkbox"/>	<input type="checkbox"/>	<input type="checkbox"/>	<input type="checkbox"/>	<input type="checkbox"/>	<input type="checkbox"/>	<input type="checkbox"/>	<input type="checkbox"/>	<input type="checkbox"/>	<input type="checkbox"/>	<input type="checkbox"/>	<input type="checkbox"/>	<input type="checkbox"/>	<input type="checkbox"/>	<input type="checkbox"/>	<input type="checkbox"/>	<input type="checkbox"/>	<input type="checkbox"/>	<input type="checkbox"/>	<input type="checkbox"/>	<input type="checkbox"/>	<input type="checkbox"/>	<input type="checkbox"/>	<input type="checkbox"/>	<input type="checkbox"/>	<input type="checkbox"/>	<input type="checkbox"/>	<input type="checkbox"/>	40		
41	<input type="checkbox"/>	<input type="checkbox"/>	<input type="checkbox"/>	<input type="checkbox"/>	<input type="checkbox"/>	<input type="checkbox"/>	<input type="checkbox"/>	<input type="checkbox"/>	<input type="checkbox"/>	<input type="checkbox"/>	<input type="checkbox"/>	<input type="checkbox"/>	<input type="checkbox"/>	<input type="checkbox"/>	<input type="checkbox"/>	<input type="checkbox"/>	<input type="checkbox"/>	<input type="checkbox"/>	<input type="checkbox"/>	<input type="checkbox"/>	<input type="checkbox"/>	<input type="checkbox"/>	<input type="checkbox"/>	<input type="checkbox"/>	<input type="checkbox"/>	<input type="checkbox"/>	<input type="checkbox"/>	<input type="checkbox"/>	41		
42	<input type="checkbox"/>	<input type="checkbox"/>	<input type="checkbox"/>	<input type="checkbox"/>	<input type="checkbox"/>	<input type="checkbox"/>	<input type="checkbox"/>	<input type="checkbox"/>	<input type="checkbox"/>	<input type="checkbox"/>	<input type="checkbox"/>	<input type="checkbox"/>	<input type="checkbox"/>	<input type="checkbox"/>	<input type="checkbox"/>	<input type="checkbox"/>	<input type="checkbox"/>	<input type="checkbox"/>	<input type="checkbox"/>	<input type="checkbox"/>	<input type="checkbox"/>	<input type="checkbox"/>	<input type="checkbox"/>	<input type="checkbox"/>	<input type="checkbox"/>	<input type="checkbox"/>	<input type="checkbox"/>	<input type="checkbox"/>	42		
43	<input type="checkbox"/>	<input type="checkbox"/>	<input type="checkbox"/>	<input type="checkbox"/>	<input type="checkbox"/>	<input type="checkbox"/>	<input type="checkbox"/>	<input type="checkbox"/>	<input type="checkbox"/>	<input type="checkbox"/>	<input type="checkbox"/>	<input type="checkbox"/>	<input type="checkbox"/>	<input type="checkbox"/>	<input type="checkbox"/>	<input type="checkbox"/>	<input type="checkbox"/>	<input type="checkbox"/>	<input type="checkbox"/>	<input type="checkbox"/>	<input type="checkbox"/>	<input type="checkbox"/>	<input type="checkbox"/>	<input type="checkbox"/>	<input type="checkbox"/>	<input type="checkbox"/>	<input type="checkbox"/>	<input type="checkbox"/>	43		
44	<input type="checkbox"/>	<input type="checkbox"/>	<input type="checkbox"/>	<input type="checkbox"/>	<input type="checkbox"/>	<input type="checkbox"/>	<input type="checkbox"/>	<input type="checkbox"/>	<input type="checkbox"/>	<input type="checkbox"/>	<input type="checkbox"/>	<input type="checkbox"/>	<input type="checkbox"/>	<input type="checkbox"/>	<input type="checkbox"/>	<input type="checkbox"/>	<input type="checkbox"/>	<input type="checkbox"/>	<input type="checkbox"/>	<input type="checkbox"/>	<input type="checkbox"/>	<input type="checkbox"/>	<input type="checkbox"/>	<input type="checkbox"/>	<input type="checkbox"/>	<input type="checkbox"/>	<input type="checkbox"/>	<input type="checkbox"/>	44		
45	<input type="checkbox"/>	<input type="checkbox"/>	<																												

The following table describes the labels in this screen.

Table 49 Advanced Application > VLAN: Port Based VLAN Setup

LABEL	DESCRIPTION
Setting Wizard	<p>Choose All connected or Port isolation.</p> <p>All connected means all ports can communicate with each other, that is, there are no virtual LANs. All incoming and outgoing ports are selected. This option is the most flexible but also the least secure.</p> <p>Port isolation means that each port can only communicate with the CPU management port and cannot communicate with each other. All incoming ports are selected while only the CPU outgoing port is selected. This option is the most limiting but also the most secure.</p> <p>After you make your selection, click Apply (top right of screen) to display the screens as mentioned above. You can still customize these settings by adding or deleting incoming or outgoing ports, but you must also click Apply at the bottom of the screen.</p>
Incoming	<p>These are the ingress ports; an ingress port is an incoming port, that is, a port through which a data packet enters. If you wish to allow two subscriber ports to talk to each other, you must define the ingress port for both ports. The numbers in the top row denote the incoming port for the corresponding port listed on the left (its outgoing port). CPU refers to the Switch management port. By default it forms a VLAN with all Ethernet ports. If it does not form a VLAN with a particular port then the Switch cannot be managed from that port.</p>
Outgoing	<p>These are the egress ports; an egress port is an outgoing port, that is, a port through which a data packet leaves. If you wish to allow two subscriber ports to talk to each other, you must define the egress port for both ports. CPU refers to the Switch management port. By default it forms a VLAN with all Ethernet ports. If it does not form a VLAN with a particular port then the Switch cannot be managed from that port.</p>
Apply	<p>Click Apply to save your changes to the Switch's run-time memory. The Switch loses these changes if it is turned off or loses power, so use the Save link on the top navigation panel to save your changes to the non-volatile memory when you are done configuring.</p>
Cancel	<p>Click Cancel to begin configuring this screen afresh.</p>

9.13 Technical Reference

This section provides technical background information on the topics discussed in this chapter.

9.13.1 Create an IP-based VLAN Example

This example shows you how to create an IP VLAN which includes ports 1, 4 and 8. Follow these steps:

- 1 Activate this protocol based VLAN.
- 2 Type the port number you want to include in this protocol based VLAN. Type **1**.
- 3 Give this protocol-based VLAN a descriptive name. Type **IP-VLAN**.
- 4 Select the protocol. Leave the default value **IP**.
- 5 Type the VLAN ID of an existing VLAN. In our example we already created a static VLAN with an ID of 5. Type **5**.
- 6 Leave the priority set to **0** and click **Add**.

Figure 105 Protocol Based VLAN Configuration Example

Protocol Based VLAN [VLAN Configuration](#)

Active	<input checked="" type="checkbox"/>
Port	<input type="text" value="1"/>
Name	<input type="text" value="IP-VLAN"/>
Ethernet-type	<input checked="" type="radio"/> IP <input type="radio"/> Others <input type="text"/> (Hex)
VID	<input type="text" value="5"/>
Priority	<input type="text" value="0"/>

Index	Active	Port	Name	Ethernet-type	VID	Priority	
							<input type="button" value="Delete"/>

To add more ports to this protocol based VLAN.

- 1 Click the index number of the protocol based VLAN entry. Click **1**.
- 2 Change the value in the **Port** field to the next port you want to add.
- 3 Click **Add**.

CHAPTER 10

Static MAC Forwarding

10.1 Overview

This chapter discusses how to configure forwarding rules based on MAC addresses of devices on your network.

Use these screens to configure static MAC address forwarding.

10.1.1 What You Can Do

Use the **Static MAC Forwarding** screen ([Section 10.2 on page 137](#)) to assign static MAC addresses for a port.

10.2 Configure Static MAC Forwarding

A static MAC address is an address that has been manually entered in the MAC address table. Static MAC addresses do not age out. When you set up static MAC address rules, you are setting static MAC addresses for a port. This may reduce the need for broadcasting.

Static MAC address forwarding together with port security allow only computers in the MAC address table on a port to access the Switch.

Click **Advanced Application > Static MAC Forwarding** in the navigation panel to display the configuration screen as shown.

Figure 106 Advanced Application > Static MAC Forwarding

Static MAC Forwarding						
Active	<input type="checkbox"/>					
Name	<input type="text"/>					
MAC Address	<input type="text"/>					
VID	<input type="text"/>					
Port	<input type="text"/>					
<input type="button" value="Add"/> <input type="button" value="Cancel"/> <input type="button" value="Clear"/>						
Index	Active	Name	MAC Address	VID	Port	<input type="checkbox"/>
<input type="button" value="Delete"/> <input type="button" value="Cancel"/>						

The following table describes the labels in this screen.

Table 50 Advanced Application > Static MAC Forwarding

LABEL	DESCRIPTION
Active	Select this check box to activate your rule. You may temporarily deactivate a rule without deleting it by clearing this check box.
Name	Enter a descriptive name for identification purposes for this static MAC address forwarding rule.
MAC Address	Enter the MAC address in valid MAC address format, that is, six hexadecimal character pairs. Note: Static MAC addresses do NOT age out.
VID	Enter the VLAN identification number.
Port	Enter the port where the MAC address entered in the previous field will be automatically forwarded.
Add	Click this to create a new entry or to update an existing one. This saves your rule to the Switch's run-time memory. The Switch loses this rule if it is turned off or loses power, so use the Save link on the top navigation panel to save your changes to the non-volatile memory when you are done configuring.
Cancel	Click Cancel to reset the fields to their last saved values.
Clear	Click Clear to begin configuring this screen afresh.
Index	Click an index number to modify a static MAC address rule for a port.
Active	This field displays whether this static MAC address forwarding rule is active (Yes) or not (No). You may temporarily deactivate a rule without deleting it.
Name	This field displays the descriptive name for identification purposes for this static MAC address-forwarding rule.
MAC Address	This field displays the MAC address that will be forwarded and the VLAN identification number to which the MAC address belongs.
VID	This field displays the ID number of the VLAN group.
Port	This field displays the port where the MAC address shown in the next field will be forwarded.
	Select an entry's check box to select a specific entry. Otherwise, select the check box in the table heading row to select all entries.
Delete	Click Delete to remove the selected entry from the summary table.
Cancel	Click Cancel to clear the check boxes.

CHAPTER 11

Static Multicast Forwarding

11.1 Overview

This chapter discusses how to configure forwarding rules based on multicast MAC addresses of devices on your network.

Use these screens to configure static multicast address forwarding.

11.1.1 What You Can Do

Use the **Static Multicast Forwarding** screen ([Section 11.2 on page 140](#)) to configure rules to forward specific multicast frames, such as streaming or control frames, to specific ports.

11.1.2 What You Need To Know

A multicast MAC address is the MAC address of a member of a multicast group. A static multicast address is a multicast MAC address that has been manually entered in the multicast table. Static multicast addresses do not age out. Static multicast forwarding allows you (the administrator) to forward multicast frames to a member without the member having to join the group first.

If a multicast group has no members, then the switch will either flood the multicast frames to all ports or drop them. [Figure 107 on page 139](#) shows such unknown multicast frames flooded to all ports. With static multicast forwarding, you can forward these multicasts to ports within a VLAN group. [Figure 108 on page 140](#) shows frames being forwarded to devices connected to port 3. [Figure 109 on page 140](#) shows frames being forwarded to ports 2 and 3 within VLAN group 4.

Figure 107 No Static Multicast Forwarding

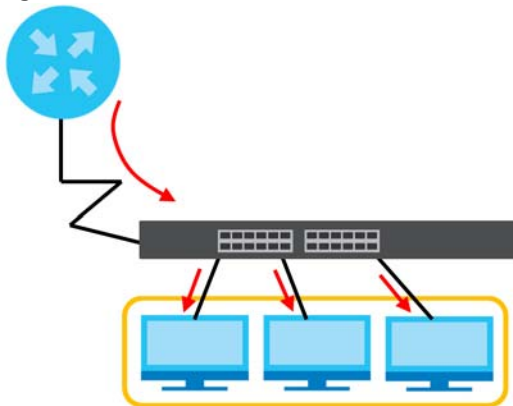

Figure 108 Static Multicast Forwarding to A Single Port

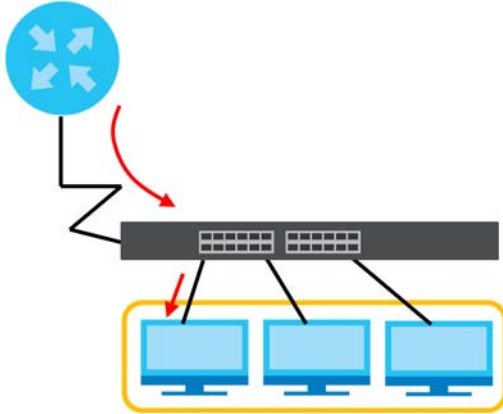
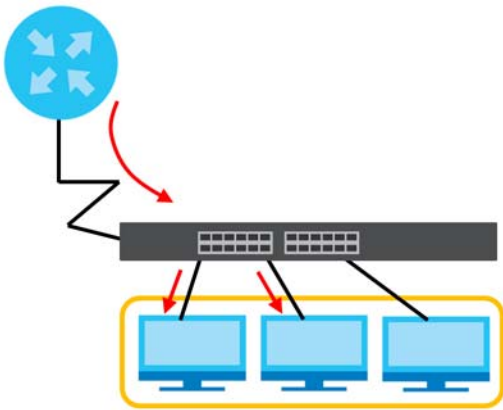

Figure 109 Static Multicast Forwarding to Multiple Ports



11.2 Configure Static Multicast Forwarding

Use this screen to configure rules to forward specific multicast frames, such as streaming or control frames, to specific ports.

Click **Advanced Application > Static Multicast Forwarding** to display the configuration screen as shown.

Figure 110 Advanced Application > Static Multicast Forwarding

The screenshot shows the configuration interface for Static Multicast Forwarding. It includes a form with the following fields: 'Active' (checkbox), 'Name', 'MAC Address', 'VID', and 'Port'. Below the form are three buttons: 'Add', 'Cancel', and 'Clear'. Underneath is a table with columns: 'Index', 'Active', 'Name', 'MAC Address', 'VID', 'Port', and a checkbox. Below the table are two buttons: 'Delete' and 'Cancel'.

The following table describes the labels in this screen.

Table 51 Advanced Application > Static Multicast Forwarding

LABEL	DESCRIPTION
Active	Select this check box to activate your rule. You may temporarily deactivate a rule without deleting it by clearing this check box.
Name	Type a descriptive name (up to 32 printable ASCII characters) for this static multicast MAC address forwarding rule. This is for identification only.
MAC Address	Enter a multicast MAC address which identifies the multicast group. The last binary bit of the first octet pair in a multicast MAC address must be 1. For example, the first octet pair 00000001 is 01 and 00000011 is 03 in hexadecimal, so 01:00:5e:00:00:0A and 03:00:5e:00:00:27 are valid multicast MAC addresses.
VID	You can forward frames with matching destination MAC address to ports within a VLAN group. Enter the ID that identifies the VLAN group here. If you do NOT have a specific target VLAN, enter 1.
Port	Enter the ports where frames with destination MAC address that matched the entry above are forwarded. You can enter multiple ports separated by (no space) comma (,) or hyphen (-). For example, enter "3-5" for ports 3, 4, and 5. Enter "3,5,7" for ports 3, 5, and 7.
Add	Click this to create a new entry or to update an existing one. This saves your rule to the Switch's run-time memory. The Switch loses this rule if it is turned off or loses power, so use the Save link on the top navigation panel to save your changes to the non-volatile memory when you are done configuring.
Cancel	Click Cancel to reset the fields to their last saved values.
Clear	Click Clear to begin configuring this screen afresh.
Index	Click an index number to modify a static multicast MAC address rule for ports.
Active	This field displays whether a static multicast MAC address forwarding rule is active (Yes) or not (No). You may temporarily deactivate a rule without deleting it.
Name	This field displays the descriptive name for identification purposes for a static multicast MAC address-forwarding rule.
MAC Address	This field displays the multicast MAC address that identifies a multicast group.
VID	This field displays the ID number of a VLAN group to which frames containing the specified multicast MAC address will be forwarded.
Port	This field displays the ports within a identified VLAN group to which frames containing the specified multicast MAC address will be forwarded.

Table 51 Advanced Application > Static Multicast Forwarding (continued)

LABEL	DESCRIPTION
	Select an entry's check box to select a specific entry. Otherwise, select the check box in the table heading row to select all entries.
Delete	Click Delete to remove the selected entry from the summary table.
Cancel	Click Cancel to clear the check boxes.

CHAPTER 12

Filtering

12.1 Filtering Overview

This chapter discusses MAC address port filtering.

Filtering means sifting traffic going through the Switch based on the source and/or destination MAC addresses and VLAN group (ID).

12.1.1 What You Can Do

Use the **Filtering** screen ([Section 12.2 on page 143](#)) to create rules for traffic going through the Switch.

12.2 Configure a Filtering Rule

Use this screen to create rules for traffic going through the Switch. Click **Advanced Application > Filtering** in the navigation panel to display the screen as shown next.

Figure 111 Advanced Application > Filtering

The screenshot shows the 'Filtering' configuration interface. It includes the following elements:

- Form Fields:**
 - Active:** A checkbox.
 - Name:** A text input field.
 - Action:** Two checkboxes: 'Discard source' and 'Discard destination'.
 - MAC:** A text input field.
 - VID:** A text input field.
- Buttons:** 'Add', 'Cancel', and 'Clear' buttons are located below the form fields.
- Table:** A table with the following columns: 'Index', 'Active', 'Name', 'MAC Address', 'VID', 'Action', and a dropdown arrow.
- Bottom Buttons:** 'Delete' and 'Cancel' buttons are located below the table.

The following table describes the related labels in this screen.

Table 52 Advanced Application > Filtering

LABEL	DESCRIPTION
Active	Make sure to select this check box to activate your rule. You may temporarily deactivate a rule without deleting it by de-selecting this check box.
Name	Type a descriptive name (up to 32 printable ASCII characters) for this rule. This is for identification only.
Action	Select Discard source to drop the frames from the source MAC address (specified in the MAC field). The Switch can still send frames to the MAC address. Select Discard destination to drop the frames to the destination MAC address (specified in the MAC address). The Switch can still receive frames originating from the MAC address. Select Discard source and Discard destination to block traffic to/from the MAC address specified in the MAC field.
MAC	Type a MAC address in valid MAC address format, that is, six hexadecimal character pairs.
VID	Type the VLAN group identification number.
Add	Click this to create a new entry or to update an existing one. This saves your changes to the Switch's run-time memory. The Switch loses these changes if it is turned off or loses power, so use the Save link on the top navigation panel to save your changes to the non-volatile memory when you are done configuring.
Cancel	Click Cancel to reset the fields to your previous configuration.
Clear	Click Clear to clear the fields to the factory defaults.
Index	This field displays the index number of the rule. Click an index number to change the settings.
Active	This field displays Yes when the rule is activated and No when is it deactivated.
Name	This field displays the descriptive name for this rule. This is for identification purpose only.
MAC Address	This field displays the source or destination MAC address with the VLAN identification number to which the MAC address belongs.
VID	This field displays the VLAN group identification number.
Action	This field displays Discard source , Discard destination , or Discard both depending on what you configured above.
	Select an entry's check box to select a specific entry. Otherwise, select the check box in the table heading row to select all entries.
Delete	Check the rules that you want to remove and then click the Delete button.
Cancel	Click Cancel to clear the selected check boxes.

CHAPTER 13

Spanning Tree Protocol

13.1 Spanning Tree Protocol Overview

The Switch supports Spanning Tree Protocol (STP), Rapid Spanning Tree Protocol (RSTP) and Multiple Spanning Tree Protocol (MSTP) as defined in the following standards.

- IEEE 802.1D Spanning Tree Protocol
- IEEE 802.1w Rapid Spanning Tree Protocol
- IEEE 802.1s Multiple Spanning Tree Protocol

The Switch also allows you to set up multiple STP configurations (or trees). Ports can then be assigned to the trees.

13.1.1 What You Can Do

- Use the **Spanning Tree Protocol Status** screen ([Section 13.2 on page 148](#)) to view the STP status in the different STP modes (RSTP, MRSTP or MSTP) you can configure on the Switch.
- Use the **Spanning Tree Configuration** screen ([Section 13.3 on page 148](#)) to activate one of the STP modes on the Switch.
- Use the **Rapid Spanning Tree Protocol Status** screen ([Section 13.4 on page 149](#)) to view the RSTP status.
- Use the **Rapid Spanning Tree Protocol** screen ([Section 13.5 on page 150](#)) to configure RSTP settings.
- Use the **Multiple Spanning Tree Protocol** screen ([Section 13.6 on page 152](#)) to configure MSTP.
- Use the **Multiple Spanning Tree Protocol Status** screen ([Section 13.7 on page 156](#)) to view the MSTP status.
- Use the **Multiple Rapid Spanning Tree Protocol** screen ([Section 13.8 on page 159](#)) to configure MRSTP.
- Use the **Multiple Rapid Spanning Tree Protocol Status** screen ([Section 13.9 on page 160](#)) to view the MRSTP status.

13.1.2 What You Need to Know

Read on for concepts on STP that can help you configure the screens in this chapter.

(Rapid) Spanning Tree Protocol

(R)STP detects and breaks network loops and provides backup links between switches, bridges or routers. It allows a switch to interact with other (R)STP-compliant switches in your network to ensure that only one path exists between any two stations on the network.

The Switch uses IEEE 802.1w RSTP (Rapid Spanning Tree Protocol) that allows faster convergence of the

spanning tree than STP (while also being backwards compatible with STP-only aware bridges). In RSTP, topology change information is directly propagated throughout the network from the device that generates the topology change. In STP, a longer delay is required as the device that causes a topology change first notifies the root bridge that then notifies the network. Both RSTP and STP flush unwanted learned addresses from the filtering database. In RSTP, the port states are Discarding, Learning, and Forwarding.

Note: In this user's guide, "STP" refers to both STP and RSTP.

STP Terminology

The root bridge is the base of the spanning tree.

Path cost is the cost of transmitting a frame onto a LAN through that port. The recommended cost is assigned according to the speed of the link to which a port is attached. The slower the media, the higher the cost.

Table 53 STP Path Costs

	LINK SPEED	RECOMMENDED VALUE	RECOMMENDED RANGE	ALLOWED RANGE
Path Cost	4 Mbps	250	100 to 1000	1 to 65535
Path Cost	10 Mbps	100	50 to 600	1 to 65535
Path Cost	16 Mbps	62	40 to 400	1 to 65535
Path Cost	100 Mbps	19	10 to 60	1 to 65535
Path Cost	1 Gbps	4	3 to 10	1 to 65535
Path Cost	10 Gbps	2	1 to 5	1 to 65535

On each bridge, the root port is the port through which this bridge communicates with the root. It is the port on this switch with the lowest path cost to the root (the root path cost). If there is no root port, then this switch has been accepted as the root bridge of the spanning tree network.

For each LAN segment, a designated bridge is selected. This bridge has the lowest cost to the root among the bridges connected to the LAN.

How STP Works

After a bridge determines the lowest cost-spanning tree with STP, it enables the root port and the ports that are the designated ports for connected LANs, and disables all other ports that participate in STP. Network packets are therefore only forwarded between enabled ports, eliminating any possible network loops.

STP-aware switches exchange Bridge Protocol Data Units (BPDUs) periodically. When the bridged LAN topology changes, a new spanning tree is constructed.

Once a stable network topology has been established, all bridges listen for Hello BPDUs (Bridge Protocol Data Units) transmitted from the root bridge. If a bridge does not get a Hello BPDU after a predefined interval (Max Age), the bridge assumes that the link to the root bridge is down. This bridge then initiates negotiations with other bridges to reconfigure the network to re-establish a valid network topology.

STP Port States

STP assigns five port states to eliminate packet looping. A bridge port is not allowed to go directly from

blocking state to forwarding state so as to eliminate transient loops.

Table 54 STP Port States

PORT STATE	DESCRIPTION
Disabled	STP is disabled (default).
Blocking	Only configuration and management BPDUs are received and processed.
Listening	All BPDUs are received and processed. Note: The listening state does NOT exist in RSTP.
Learning	All BPDUs are received and processed. Information frames are submitted to the learning process but not forwarded.
Forwarding	All BPDUs are received and processed. All information frames are received and forwarded.

Multiple RSTP

MRSTP (Multiple RSTP) is Zyxel's proprietary feature that is compatible with RSTP and STP. With MRSTP, you can have more than one spanning tree on your Switch and assign ports to each tree. Each spanning tree operates independently with its own bridge information.

In the following example, there are two RSTP instances (**MRSTP 1** and **MRSTP2**) on switch **A**.

To set up MRSTP, activate MRSTP on the Switch and specify which ports belong to which spanning tree.

Note: Each port can belong to one STP tree only.

Figure 112 MRSTP Network Example

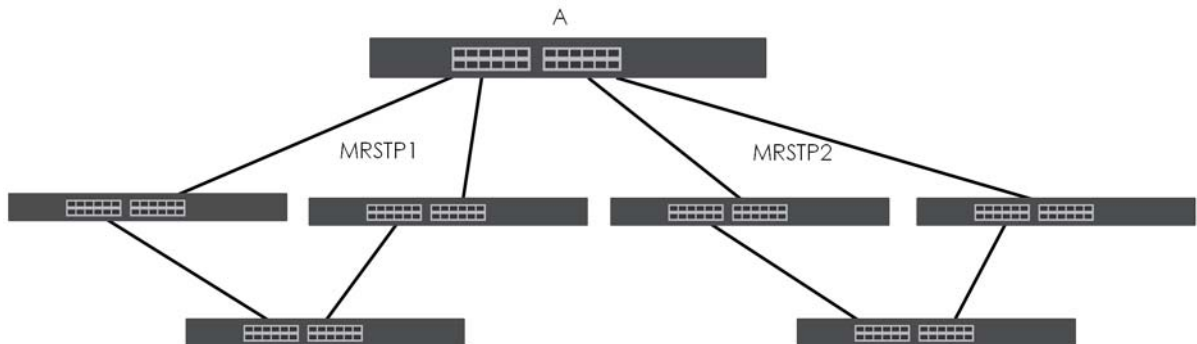

Multiple STP

Multiple Spanning Tree Protocol (IEEE 802.1s) is backward compatible with STP/RSTP and addresses the limitations of existing spanning tree protocols (STP and RSTP) in networks to include the following features:

- One Common and Internal Spanning Tree (CIST) that represents the entire network's connectivity.
- Grouping of multiple bridges (or switching devices) into regions that appear as one single bridge on the network.
- A VLAN can be mapped to a specific Multiple Spanning Tree Instance (MSTI). MSTI allows multiple VLANs to use the same spanning tree.
- Load-balancing is possible as traffic from different VLANs can use distinct paths in a region.

13.2 Spanning Tree Protocol Status

The Spanning Tree Protocol status screen changes depending on what standard you choose to implement on your network. Click **Advanced Application > Spanning Tree Protocol** to see the screen as shown.

Figure 113 Advanced Application > Spanning Tree Protocol

The screenshot shows the 'Spanning Tree Protocol Status' screen for RSTP. It includes a table with the following data:

Bridge	Root	Our Bridge
Bridge ID	0000-000000000000	0000-000000000000
Hello Time (second)	0	0
Max Age (second)	0	0
Forwarding Delay (second)	0	0
Cost to Bridge	0	0
Port ID	0X0000	
Topology Changed Times	0	
Time Since Last Change	0:00:00	

Below the table is a header for a port configuration table:

Port	Port State	Port Role	Designated Bridge ID	Designated Port ID	Designated Cost
------	------------	-----------	----------------------	--------------------	-----------------

This screen differs depending on which STP mode (RSTP or MSTP) you configure on the Switch. This screen is described in detail in the section that follows the configuration section for each STP mode. Click **Configuration** to activate one of the STP standards on the Switch.

13.3 Spanning Tree Configuration

Use the **Spanning Tree Configuration** screen to activate one of the STP modes on the Switch. Click **Configuration** in the **Advanced Application > Spanning Tree Protocol**.

Figure 114 Advanced Application > Spanning Tree Protocol > Configuration

The screenshot shows the 'Spanning Tree Configuration' screen with the following options:

- Rapid Spanning Tree
- Multiple Rapid Spanning Tree
- Multiple Spanning Tree

Buttons for **Apply** and **Cancel** are visible at the bottom.

The following table describes the labels in this screen.

Table 55 Advanced Application > Spanning Tree Protocol > Configuration

LABEL	DESCRIPTION
Spanning Tree Mode	You can activate one of the STP modes on the Switch. Select Rapid Spanning Tree , Multiple Rapid Spanning Tree or Multiple Spanning Tree .
Apply	Click Apply to save your changes to the Switch's run-time memory. The Switch loses these changes if it is turned off or loses power, so use the Save link on the top navigation panel to save your changes to the non-volatile memory when you are done configuring.
Cancel	Click Cancel to begin configuring this screen afresh.

13.4 Rapid Spanning Tree Protocol Status

The Spanning Tree Protocol status screen changes depending on what standard you choose to implement on your network. Click **Advanced Application > Spanning Tree Protocol** in the navigation panel to display the status screen as shown next. See [Section 13.1 on page 145](#) for more information on RSTP.

Note: This screen is only available after you activate RSTP on the Switch.

Figure 115 Advanced Application > Spanning Tree Protocol > Spanning Tree Protocol Status: RSTP

Spanning Tree Protocol Status			Configuration	RSTP	MRSTP	MSTP
Spanning Tree Protocol: RSTP						
Bridge	Root	Our Bridge				
Bridge ID	0000-000000000000	0000-000000000000				
Hello Time (second)	0	0				
Max Age (second)	0	0				
Forwarding Delay (second)	0	0				
Cost to Bridge	0					
Port ID	0x0000					
Topology Changed Times	0					
Time Since Last Change	0:00:00					
Port	Port State	Port Role	Designated Bridge ID	Designated Port ID	Designated Cost	

The following table describes the labels in this screen.

Table 56 Advanced Application > Spanning Tree Protocol > Spanning Tree Protocol Status: RSTP

LABEL	DESCRIPTION
Bridge	Root refers to the base of the spanning tree (the root bridge). Our Bridge is this Switch. This Switch may also be the root bridge.
Bridge ID	This is the unique identifier for this bridge, consisting of bridge priority plus MAC address. This ID is the same for Root and Our Bridge if the Switch is the root switch.
Hello Time (second)	This is the time interval (in seconds) at which the root switch transmits a configuration message. The root bridge determines Hello Time, Max Age and Forwarding Delay.
Max Age (second)	This is the maximum time (in seconds) the Switch can wait without receiving a configuration message before attempting to reconfigure.
Forwarding Delay (second)	This is the time (in seconds) the root switch will wait before changing states (that is, listening to learning to forwarding). Note: The listening state does NOT exist in RSTP.
Cost to Bridge	This is the path cost from the root port on this Switch to the root switch.
Port ID	This is the priority and number of the port on the Switch through which this Switch must communicate with the root of the Spanning Tree.
Topology Changed Times	This is the number of times the spanning tree has been reconfigured.
Time Since Last Change	This is the time since the spanning tree was last reconfigured.
Port	This field displays the number of the port on the Switch.

Table 56 Advanced Application > Spanning Tree Protocol > Spanning Tree Protocol Status: RSTP

LABEL	DESCRIPTION
Port State	<p>This field displays the port state in STP.</p> <ul style="list-style-type: none"> • Discarding – The port does not forward or process received frames or learn MAC addresses, but still listens for BPDUs. • Learning – The port learns MAC addresses and processes BPDUs, but does NOT forward frames yet. • Forwarding – The port is operating normally. It learns MAC addresses, processes BPDUs and forwards received frames.
Port Role	<p>This field displays the role of the port in STP.</p> <ul style="list-style-type: none"> • Root – A forwarding port on a non-root bridge, which has the lowest path cost and is the best port from the non-root bridge to the root bridge. A root bridge does NOT have a root port. • Designated – A forwarding port on the designated bridge for each connected LAN segment. A designated bridge has the lowest path cost to the root bridge among the bridges connected to the LAN segment. All the ports on a root bridge (root switch) are designated ports. • Alternate – A blocked port, which has a best alternate path to the root bridge. This path is different from using the root port. The port moves to the forwarding state when the designated port for the LAN segment fails. • Backup – A blocked port, which has a backup or redundant path to a LAN segment where a designated port is already connected when a switch has two links to the same LAN segment. • Disabled – Not strictly part of STP. The port can be disabled manually.
Designated Bridge ID	<p>This field displays the identifier of the designated bridge to which this port belongs when the port is a designated port. Otherwise, it displays the identifier of the designated bridge for the LAN segment to which this port is connected.</p>
Designated Port ID	<p>This field displays the priority and number of the bridge port (on the designated bridge), through which the designated bridge transmits the stored configuration messages.</p>
Designated Cost	<p>This field displays the path cost to the LAN segment to which the port is connected when the port is a designated port. Otherwise, it displays the path cost to the root bridge from the designated port for the LAN segment to which this port is connected.</p>

13.5 Configure Rapid Spanning Tree Protocol

Use this screen to configure RSTP settings, see [Section 13.1 on page 145](#) for more information on RSTP. Click **RSTP** in the **Advanced Application > Spanning Tree Protocol** screen.

Figure 116 Advanced Application > Spanning Tree Protocol > RSTP

Rapid Spanning Tree Protocol		Status
Active	<input type="checkbox"/>	
Bridge Priority	32768 ▼	
Hello Time	2 Seconds	
MAX Age	20 Seconds	
Forwarding Delay	15 Seconds	

Port	Active	Edge	Priority	Path Cost
*	<input type="checkbox"/>	<input type="checkbox"/>		
1	<input type="checkbox"/>	<input type="checkbox"/>	128	4
2	<input type="checkbox"/>	<input type="checkbox"/>	128	4
3	<input type="checkbox"/>	<input type="checkbox"/>	128	4
4	<input type="checkbox"/>	<input type="checkbox"/>	128	4
5	<input type="checkbox"/>	<input type="checkbox"/>	128	4

The following table describes the labels in this screen.

Table 57 Advanced Application > Spanning Tree Protocol > RSTP

LABEL	DESCRIPTION
Status	Click Status to display the RSTP Status screen.
Active	<p>Select this check box to activate RSTP. Clear this check box to disable RSTP.</p> <p>Note: You must also activate Rapid Spanning Tree in the Advanced Application > Spanning Tree Protocol > Configuration screen to enable RSTP on the Switch.</p>
Bridge Priority	<p>Bridge priority is used in determining the root switch, root port and designated port. The Switch with the highest priority (lowest numeric value) becomes the STP root switch. If all Switches have the same priority, the Switch with the lowest MAC address will then become the root switch. Select a value from the drop-down list box.</p> <p>The lower the numeric value you assign, the higher the priority for this bridge.</p> <p>Bridge Priority determines the root bridge, which in turn determines Hello Time, Max Age and Forwarding Delay.</p>
Hello Time	This is the time interval in seconds between BPDU (Bridge Protocol Data Units) configuration message generations by the root switch. The allowed range is 1 to 10 seconds.
Max Age	This is the maximum time (in seconds) the Switch can wait without receiving a BPDU before attempting to reconfigure. All Switch ports (except for designated ports) should receive BPDUs at regular intervals. Any port that ages out STP information (provided in the last BPDU) becomes the designated port for the attached LAN. If it is a root port, a new root port is selected from among the Switch ports attached to the network. The allowed range is 6 to 40 seconds.
Forwarding Delay	<p>This is the maximum time (in seconds) the Switch will wait before changing states. This delay is required because every Switch must receive information about topology changes before it starts to forward frames. In addition, each port needs time to listen for conflicting information that would make it return to a blocking state; otherwise, temporary data loops might result. The allowed range is 4 to 30 seconds.</p> <p>As a general rule:</p> $2 * (\text{Forward Delay} - 1) \geq \text{Max Age} \geq 2 * (\text{Hello Time} + 1)$

Table 57 Advanced Application > Spanning Tree Protocol > RSTP (continued)

LABEL	DESCRIPTION
Port	This field displays the port number.
*	<p>Settings in this row apply to all ports.</p> <p>Use this row only if you want to make some settings the same for all ports. Use this row first to set the common settings and then make adjustments on a port-by-port basis.</p> <p>Note: Changes in this row are copied to all the ports as soon as you make them.</p>
Active	Select this check box to activate RSTP on this port.
Edge	<p>Select this check box to configure a port as an edge port when it is directly attached to a computer. An edge port changes its initial STP port state from blocking state to forwarding state immediately without going through listening and learning states right after the port is configured as an edge port or when its link status changes.</p> <p>Note: An edge port becomes a non-edge port as soon as it receives a Bridge Protocol Data Unit (BPDU).</p>
Priority	<p>Configure the priority for each port here.</p> <p>Priority decides which port should be disabled when more than one port forms a loop in a switch. Ports with a higher priority numeric value are disabled first. The allowed range is between 0 and 255 and the default value is 128.</p>
Path Cost	Path cost is the cost of transmitting a frame on to a LAN through that port. It is recommended to assign this value according to the speed of the bridge. The slower the media, the higher the cost.
Apply	Click Apply to save your changes to the Switch's run-time memory. The Switch loses these changes if it is turned off or loses power, so use the Save link on the top navigation panel to save your changes to the non-volatile memory when you are done configuring.
Cancel	Click Cancel to begin configuring this screen afresh.

13.6 Configure Multiple Spanning Tree Protocol

To configure MSTP, click **MSTP** in the **Advanced Application > Spanning Tree Protocol** screen.

Figure 117 Advanced Application > Spanning Tree Protocol > MSTP

Multiple Spanning Tree Protocol
[Status](#) [Port](#)

Bridge

Active	<input type="checkbox"/>	
Hello Time	2	seconds
MAX Age	20	seconds
Forwarding Delay	15	seconds
Maximum hops	20	
Configuration Name	1c740dfef65e	
Revision Number	0	

Apply
Cancel

Instance

Instance		
Bridge Priority	32768	▼
VLAN Range	Start <input type="text"/>	End <input type="text"/> Add Remove Clear
Enabled VLAN(s)		

Port	Active	Priority	Path Cost
*	<input type="checkbox"/>		
1	<input type="checkbox"/>	128	4
2	<input type="checkbox"/>	128	4
3	<input type="checkbox"/>	128	4
4	<input type="checkbox"/>	128	4
5	<input type="checkbox"/>	128	4
6	<input type="checkbox"/>	128	2

Add
Cancel

Instance	VLAN	Active Port
0	1-4094	-

Delete
Cancel

The following table describes the labels in this screen.

Table 58 Advanced Application > Spanning Tree Protocol > MSTP

LABEL	DESCRIPTION
Status	Click Status to display the MSTP Status screen.
Port	Click Port to display the MSTP Port screen.
Active	<p>Select this check box to activate MSTP on the Switch. Clear this check box to disable MSTP on the Switch.</p> <p>Note: You must also activate Multiple Spanning Tree in the Advanced Application > Spanning Tree Protocol > Configuration screen to enable MSTP on the Switch.</p>
Hello Time	This is the time interval in seconds between BPDU (Bridge Protocol Data Units) configuration message generations by the root switch. The allowed range is 1 to 10 seconds.

Table 58 Advanced Application > Spanning Tree Protocol > MSTP (continued)

LABEL	DESCRIPTION
MaxAge	This is the maximum time (in seconds) a switch can wait without receiving a BPDU before attempting to reconfigure. All switch ports (except for designated ports) should receive BPDUs at regular intervals. Any port that ages out STP information (provided in the last BPDU) becomes the designated port for the attached LAN. If it is a root port, a new root port is selected from among the Switch ports attached to the network. The allowed range is 6 to 40 seconds.
Forwarding Delay	This is the maximum time (in seconds) a switch will wait before changing states. This delay is required because every switch must receive information about topology changes before it starts to forward frames. In addition, each port needs time to listen for conflicting information that would make it return to a blocking state; otherwise, temporary data loops might result. The allowed range is 4 to 30 seconds. As a general rule: Note: $2 * (\text{Forward Delay} - 1) \geq \text{Max Age} \geq 2 * (\text{Hello Time} + 1)$
Maximum hops	Enter the number of hops (between 1 and 255) in an MSTP region before the BPDU is discarded and the port information is aged.
Configuration Name	Enter a descriptive name (up to 32 characters) of an MST region.
Revision Number	Enter a number to identify a region's configuration. Devices must have the same revision number to belong to the same region.
Apply	Click Apply to save your changes to the Switch's run-time memory. The Switch loses these changes if it is turned off or loses power, so use the Save link on the top navigation panel to save your changes to the non-volatile memory when you are done configuring.
Cancel	Click Cancel to begin configuring this screen afresh.
Instance	Use this section to configure MSTI (Multiple Spanning Tree Instance) settings.
Instance	Enter the number you want to use to identify this MST instance on the Switch. The Switch supports instance numbers 0 – 15.
Bridge Priority	Set the priority of the Switch for the specific spanning tree instance. The lower the number, the more likely the Switch will be chosen as the root bridge within the spanning tree instance. Enter priority values between 0 and 61440 in increments of 4096 (thus valid values are 4096, 8192, 12288, 16384, 20480, 24576, 28672, 32768, 36864, 40960, 45056, 49152, 53248, 57344 and 61440).
VLAN Range	Enter the start of the VLAN ID range that you want to add or remove from the VLAN range edit area in the Start field. Enter the end of the VLAN ID range that you want to add or remove from the VLAN range edit area in the End field. Next click: <ul style="list-style-type: none">• Add – to add this range of VLANs to be mapped to the MST instance.• Remove – to remove this range of VLANs from being mapped to the MST instance.• Clear – to remove all VLANs from being mapped to this MST instance.
Enabled VLAN(s)	This field displays which VLANs are mapped to this MST instance.
Port	This field displays the port number. * means all ports.
*	Settings in this row apply to all ports. Use this row only if you want to make some settings the same for all ports. Use this row first to set the common settings and then make adjustments on a port-by-port basis. Note: Changes in this row are copied to all the ports as soon as you make them.
Active	Select this check box to add this port to the MST instance.
Priority	Configure the priority for each port here. Priority decides which port should be disabled when more than one port forms a loop in the Switch. Ports with a higher priority numeric value are disabled first. The allowed range is between 0 and 255 and the default value is 128.

Table 58 Advanced Application > Spanning Tree Protocol > MSTP (continued)

LABEL	DESCRIPTION
Path Cost	Path cost is the cost of transmitting a frame on to a LAN through that port. It is recommended to assign this value according to the speed of the bridge. The slower the media, the higher the cost.
Add	Click this to create a new entry or to update an existing one. This saves your changes to the Switch's run-time memory. The Switch loses this change if it is turned off or loses power, so use the Save link on the top navigation panel to save your changes to the non-volatile memory when you are done configuring.
Cancel	Click Cancel to begin configuring this screen afresh.
Instance	This field displays the ID of an MST instance.
VLAN	This field displays the VID (or VID ranges) to which the MST instance is mapped.
Active Port	This field display the ports configured to participate in the MST instance.
	Select an entry's check box to select a specific entry. Otherwise, select the check box in the table heading row to select all entries.
Delete	Check the rules that you want to remove and then click the Delete button.
Cancel	Click Cancel to clear the selected check boxes.

13.6.1 Multiple Spanning Tree Protocol Port Configuration

Click **Advanced Application > Spanning Tree Protocol > MSTP > Port** in the navigation panel to display the status screen as shown next.

Figure 118 Advanced Application > Spanning Tree Protocol > MSTP > Port

Port	Edge
*	<input type="checkbox"/>
1	<input type="checkbox"/>
2	<input type="checkbox"/>
3	<input type="checkbox"/>
4	<input type="checkbox"/>
5	<input type="checkbox"/>
6	<input type="checkbox"/>
7	<input type="checkbox"/>
8	<input type="checkbox"/>
9	<input type="checkbox"/>
10	<input type="checkbox"/>
48	<input type="checkbox"/>
49	<input type="checkbox"/>
50	<input type="checkbox"/>

The following table describes the labels in this screen.

Table 59 Advanced Application > Spanning Tree Protocol > MSTP > Port

LABEL	DESCRIPTION
MSTP	Click MSTP to edit MSTP settings on the Switch.
Port	This field displays the port number. * means all ports.

Table 59 Advanced Application > Spanning Tree Protocol > MSTP > Port (continued)

LABEL	DESCRIPTION
*	<p>Settings in this row apply to all ports.</p> <p>Use this row only if you want to make some settings the same for all ports. Use this row first to set the common settings and then make adjustments on a port-by-port basis.</p> <p>Note: Changes in this row are copied to all the ports as soon as you make them.</p>
Edge	<p>Select this check box to configure a port as an edge port when it is directly attached to a computer. An edge port changes its initial STP port state from blocking state to forwarding state immediately without going through listening and learning states right after the port is configured as an edge port or when its link status changes.</p> <p>Note: An edge port becomes a non-edge port as soon as it receives a Bridge Protocol Data Unit (BPDU).</p>
Apply	<p>Click Apply to save your changes to the Switch's run-time memory. The Switch loses these changes if it is turned off or loses power, so use the Save link on the top navigation panel to save your changes to the non-volatile memory when you are done configuring.</p>
Cancel	<p>Click Cancel to begin configuring this screen afresh.</p>

13.7 Multiple Spanning Tree Protocol Status

Click **Advanced Application > Spanning Tree Protocol** in the navigation panel to display the status screen as shown next.

Note: This screen is only available after you activate MSTP on the Switch.

Figure 119 Advanced Application > Spanning Tree Protocol > Status: MSTP

Spanning Tree Protocol Status			Configuration RSTP MRSTP MSTP
Spanning Tree Protocol: MSTP			
CST			
Bridge	Root	Our Bridge	
Bridge ID	0000-000000000000	0000-000000000000	
Hello Time (second)	0	0	
Max Age (second)	0	0	
Forwarding Delay (second)	0	0	
Cost to Bridge	0	0	
Port ID	0x0000	0x0000	
Configuration Name	bc99118da6a5		
Revision Number	0		
Configuration Digest	0		
Topology Changed Times	0		
Time Since Last Change	0:00:00		
Instance			
Instance	VLAN		
0	1-4094		
MSTI 0			
Bridge	Regional Root	Our Bridge	
Bridge ID	0000-000000000000	0000-000000000000	
Internal Cost	0	0	
Port ID	0x0000	0x0000	
Port	Port State	Port Role	Designated Bridge ID
			Designated Port ID
			Designated Cost

The following table describes the labels in this screen.

Table 60 Advanced Application > Spanning Tree Protocol > Status: MSTP

LABEL	DESCRIPTION
Configuration	Click Configuration to specify which STP mode you want to activate. Click MSTP to edit MSTP settings on the Switch.
CST	This section describes the Common Spanning Tree settings.
Bridge	Root refers to the base of the spanning tree (the root bridge). Our Bridge is this switch. This Switch may also be the root bridge.
Bridge ID	This is the unique identifier for this bridge, consisting of bridge priority plus MAC address. This ID is the same for Root and Our Bridge if the Switch is the root switch.
Hello Time (second)	This is the time interval (in seconds) at which the root switch transmits a configuration message. The root bridge determines Hello Time, Max Age and Forwarding Delay.
Max Age (second)	This is the maximum time (in seconds) the Switch can wait without receiving a configuration message before attempting to reconfigure.
Forwarding Delay (second)	This is the time (in seconds) the root switch will wait before changing states (that is, listening to learning to forwarding).
Cost to Bridge	This is the path cost from the root port on this Switch to the root switch.
Port ID	This is the priority and number of the port on the Switch through which this Switch must communicate with the root of the Spanning Tree.
Configuration Name	This field displays the configuration name for this MST region.
Revision Number	This field displays the revision number for this MST region.

Table 60 Advanced Application > Spanning Tree Protocol > Status: MSTP (continued)

LABEL	DESCRIPTION
Configuration Digest	A configuration digest is generated from the VLAN-MSTI mapping information. This field displays the 16-octet signature that is included in an MSTP BPDU. This field displays the digest when MSTP is activated on the system.
Topology Changed Times	This is the number of times the spanning tree has been reconfigured.
Time Since Last Change	This is the time since the spanning tree was last reconfigured.
Instance	These fields display the MSTI to VLAN mapping. In other words, which VLANs run on each spanning tree instance.
Instance	This field displays the MSTI ID.
VLAN	This field displays which VLANs are mapped to an MSTI.
MSTI	Select the MST instance settings you want to view.
Bridge	Root refers to the base of the MST instance. Our Bridge is this switch. This Switch may also be the root bridge.
Bridge ID	This is the unique identifier for this bridge, consisting of bridge priority plus MAC address. This ID is the same for Root and Our Bridge if the Switch is the root switch.
Internal Cost	This is the path cost from the root port in this MST instance to the regional root switch.
Port ID	This is the priority and number of the port on the Switch through which this Switch must communicate with the root of the MST instance.
Port	This field displays the number of the port on the Switch.
Port State	This field displays the port state in STP. <ul style="list-style-type: none"> • Discarding – The port does not forward or process received frames or learn MAC addresses, but still listens for BPDUs. • Learning – The port learns MAC addresses and processes BPDUs, but does not forward frames yet. • Forwarding – The port is operating normally. It learns MAC addresses, processes BPDUs and forwards received frames.
Port Role	This field displays the role of the port in STP. <ul style="list-style-type: none"> • Root – A forwarding port on a non-root bridge, which has the lowest path cost and is the best port from the non-root bridge to the root bridge. A root bridge does not have a root port. • Designated – A forwarding port on the designated bridge for each connected LAN segment. A designated bridge has the lowest path cost to the root bridge among the bridges connected to the LAN segment. All the ports on a root bridge (root switch) are designated ports. • Alternate – A blocked port, which has a best alternate path to the root bridge. This path is different from using the root port. The port moves to the forwarding state when the designated port for the LAN segment fails. • Backup – A blocked port, which has a backup or redundant path to a LAN segment where a designated port is already connected when a switch has two links to the same LAN segment. • Disabled – Not strictly part of STP. The port can be disabled manually.
Designated Bridge ID	This field displays the identifier of the designated bridge to which this port belongs when the port is a designated port. Otherwise, it displays the identifier of the designated bridge for the LAN segment to which this port is connected.
Designated Port ID	This field displays the priority and number of the bridge port (on the designated bridge), through which the designated bridge transmits the stored configuration messages.
Designated Cost	This field displays the path cost to the LAN segment to which the port is connected when the port is a designated port. Otherwise, it displays the path cost to the root bridge from the designated port for the LAN segment to which this port is connected.

13.8 Configure Multiple Rapid Spanning Tree Protocol

To configure MRSTP, click **MRSTP** in the **Advanced Application > Spanning Tree Protocol** screen.

Figure 120 Advanced Application > Spanning Tree Protocol > MRSTP

Tree	Active	Bridge Priority	Hello Time	MAX Age	Forwarding Delay
1	<input type="checkbox"/>	32768	2 seconds	20 seconds	15 seconds
2	<input type="checkbox"/>	32768	2 seconds	20 seconds	15 seconds

Port	Active	Edge	Root Guard	Priority	Path Cost	Tree
*	<input type="checkbox"/>	<input type="checkbox"/>	<input type="checkbox"/>			1
1	<input type="checkbox"/>	<input type="checkbox"/>	<input type="checkbox"/>	128	4	1
2	<input type="checkbox"/>	<input type="checkbox"/>	<input type="checkbox"/>	128	4	1
3	<input type="checkbox"/>	<input type="checkbox"/>	<input type="checkbox"/>	128	4	1
4	<input type="checkbox"/>	<input type="checkbox"/>	<input type="checkbox"/>	128	4	1
5	<input type="checkbox"/>	<input type="checkbox"/>	<input type="checkbox"/>	128	4	1
6	<input type="checkbox"/>	<input type="checkbox"/>	<input type="checkbox"/>	128	4	1
7	<input type="checkbox"/>	<input type="checkbox"/>	<input type="checkbox"/>	128	4	1
8	<input type="checkbox"/>	<input type="checkbox"/>	<input type="checkbox"/>	128	4	1
9	<input type="checkbox"/>	<input type="checkbox"/>	<input type="checkbox"/>	128	4	1

The following table describes the labels in this screen.

Table 61 Advanced Application > Spanning Tree Protocol > MRSTP

LABEL	DESCRIPTION
Status	Click Status to display the MRSTP Status screen.
Tree	This is a read only index number of the STP trees.
Active	Select this check box to activate an STP tree. Clear this check box to disable an STP tree. Note: You must also activate Multiple Rapid Spanning Tree in the Advanced Application > Spanning Tree Protocol > Configuration screen to enable MRSTP on the Switch.
Bridge Priority	Bridge priority is used in determining the root switch, root port and designated port. The switch with the highest priority (lowest numeric value) becomes the STP root switch. If all switches have the same priority, the switch with the lowest MAC address will then become the root switch. Select a value from the drop-down list box. The lower the numeric value you assign, the higher the priority for this bridge. Bridge Priority determines the root bridge, which in turn determines Hello Time, Max Age and Forwarding Delay.
Hello Time	This is the time interval in seconds between BPDU (Bridge Protocol Data Units) configuration message generations by the root switch. The allowed range is 1 to 10 seconds.
Max Age	This is the maximum time (in seconds) the Switch can wait without receiving a BPDU before attempting to reconfigure. All Switch ports (except for designated ports) should receive BPDUs at regular intervals. Any port that ages out STP information (provided in the last BPDU) becomes the designated port for the attached LAN. If it is a root port, a new root port is selected from among the Switch ports attached to the network. The allowed range is 6 to 40 seconds.

Table 61 Advanced Application > Spanning Tree Protocol > MRSTP (continued)

LABEL	DESCRIPTION
Forwarding Delay	<p>This is the maximum time (in seconds) the Switch will wait before changing states. This delay is required because every switch must receive information about topology changes before it starts to forward frames. In addition, each port needs time to listen for conflicting information that would make it return to a blocking state; otherwise, temporary data loops might result. The allowed range is 4 to 30 seconds.</p> <p>As a general rule:</p> $2 * (\text{Forward Delay} - 1) \geq \text{Max Age} \geq 2 * (\text{Hello Time} + 1)$
Port	This field displays the port number.
*	<p>Settings in this row apply to all ports.</p> <p>Use this row only if you want to make some settings the same for all ports. Use this row first to set the common settings and then make adjustments on a port-by-port basis.</p> <p>Note: Changes in this row are copied to all the ports as soon as you make them.</p>
Active	Select this check box to activate STP on this port.
Edge	<p>Select this check box to configure a port as an edge port when it is directly attached to a computer. An edge port changes its initial STP port state from blocking state to forwarding state immediately without going through listening and learning states right after the port is configured as an edge port or when its link status changes.</p> <p>Note: An edge port becomes a non-edge port as soon as it receives a Bridge Protocol Data Unit (BPDU).</p>
Priority	<p>Configure the priority for each port here.</p> <p>Priority decides which port should be disabled when more than one port forms a loop in a switch. Ports with a higher priority numeric value are disabled first. The allowed range is between 0 and 255 and the default value is 128.</p>
Path Cost	Path cost is the cost of transmitting a frame on to a LAN through that port. It is recommended to assign this value according to the speed of the bridge. The slower the media, the higher the cost.
Tree	Select which STP tree configuration this port should participate in.
Apply	Click Apply to save your changes to the Switch's run-time memory. The Switch loses these changes if it is turned off or loses power, so use the Save link on the top navigation panel to save your changes to the non-volatile memory when you are done configuring.
Cancel	Click Cancel to begin configuring this screen afresh.

13.9 Multiple Rapid Spanning Tree Protocol Status

Click **Advanced Application > Spanning Tree Protocol** in the navigation panel to display the status screen as shown next. See [Section 13.9 on page 160](#) for more information on MRSTP.

Note: This screen is only available after you activate MRSTP on the Switch.

Figure 121 Advanced Application > Spanning Tree Protocol > Status: MRSTP

Spanning Tree Protocol Status			Configuration	RSTP	MRSTP	MSTP
Spanning Tree Protocol: MRSTP						
Tree 1 ▾						
Bridge	Root	Our Bridge				
Bridge ID	0000-000000000000	0000-000000000000				
Hello Time (second)	0	0				
Max Age (second)	0	0				
Forwarding Delay (second)	0	0				
Cost to Bridge	0					
Port ID	0X0000					
Topology Changed Times	0					
Time Since Last Change	0:00:00					
Port	Port State	Port Role	Designated Bridge ID	Designated Port ID	Designated Cost	

The following table describes the labels in this screen.

Table 62 Advanced Application > Spanning Tree Protocol > Status: MRSTP

LABEL	DESCRIPTION
Configuration	Click Configuration to specify which STP mode you want to activate. Click MRSTP to edit MRSTP settings on the Switch.
Tree	Select which STP tree configuration you want to view.
Bridge	Root refers to the base of the spanning tree (the root bridge). Our Bridge is this switch. This Switch may also be the root bridge.
Bridge ID	This is the unique identifier for this bridge, consisting of bridge priority plus MAC address. This ID is the same for Root and Our Bridge if the Switch is the root switch.
Hello Time (second)	This is the time interval (in seconds) at which the root switch transmits a configuration message. The root bridge determines Hello Time, Max Age and Forwarding Delay.
Max Age (second)	This is the maximum time (in seconds) the Switch can wait without receiving a configuration message before attempting to reconfigure.
Forwarding Delay (second)	This is the time (in seconds) the root switch will wait before changing states (that is, listening to learning to forwarding). Note: The listening state does not exist in RSTP.
Cost to Bridge	This is the path cost from the root port on this Switch to the root switch.
Port ID	This is the priority and number of the port on the Switch through which this Switch must communicate with the root of the Spanning Tree.
Topology Changed Times	This is the number of times the spanning tree has been reconfigured.
Time Since Last Change	This is the time since the spanning tree was last reconfigured.
Port	This field displays the number of the port on the Switch.
Port State	This field displays the port state in STP. <ul style="list-style-type: none"> • Discarding – The port does not forward or process received frames or learn MAC addresses, but still listens for BPDUs. • Learning – The port learns MAC addresses and processes BPDUs, but does not forward frames yet. • Forwarding – The port is operating normally. It learns MAC addresses, processes BPDUs and forwards received frames.

Table 62 Advanced Application > Spanning Tree Protocol > Status: MRSTP (continued)

LABEL	DESCRIPTION
Port Role	<p>This field displays the role of the port in STP.</p> <ul style="list-style-type: none"> • Root – A forwarding port on a non-root bridge, which has the lowest path cost and is the best port from the non-root bridge to the root bridge. A root bridge does not have a root port. • Designated – A forwarding port on the designated bridge for each connected LAN segment. A designated bridge has the lowest path cost to the root bridge among the bridges connected to the LAN segment. All the ports on a root bridge (root switch) are designated ports. • Alternate – A blocked port, which has a best alternate path to the root bridge. This path is different from using the root port. The port moves to the forwarding state when the designated port for the LAN segment fails. • Backup – A blocked port, which has a backup or redundant path to a LAN segment where a designated port is already connected when a switch has two links to the same LAN segment. • Disabled – Not strictly part of STP. The port can be disabled manually.
Designated Bridge ID	This field displays the identifier of the designated bridge to which this port belongs when the port is a designated port. Otherwise, it displays the identifier of the designated bridge for the LAN segment to which this port is connected.
Designated Port ID	This field displays the priority and number of the bridge port (on the designated bridge), through which the designated bridge transmits the stored configuration messages.
Designated Cost	This field displays the path cost to the LAN segment to which the port is connected when the port is a designated port. Otherwise, it displays the path cost to the root bridge from the designated port for the LAN segment to which this port is connected.

13.10 Technical Reference

This section provides technical background information on the topics discussed in this chapter.

13.10.1 MSTP Network Example

The following figure shows a network example where two VLANs are configured on the two switches. If the switches are using STP or RSTP, the link for VLAN 2 will be blocked as STP and RSTP allow only one link in the network and block the redundant link.

Figure 122 STP/RSTP Network Example

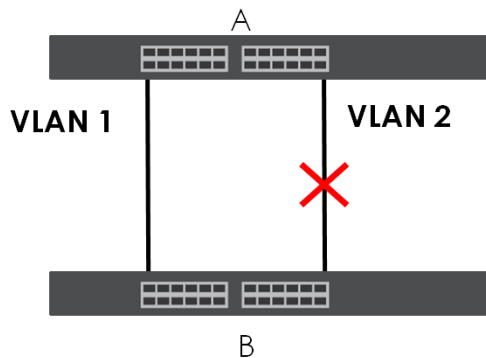

With MSTP, VLANs 1 and 2 are mapped to different spanning trees in the network. Thus traffic from the two VLANs travel on different paths. The following figure shows the network example using MSTP.

Figure 123 MSTP Network Example

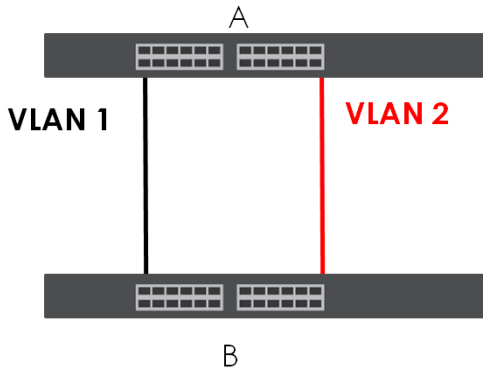

13.10.2 MST Region

An MST region is a logical grouping of multiple network devices that appears as a single device to the rest of the network. Each MSTP-enabled device can only belong to one MST region. When BPDUs enter an MST region, external path cost (of paths outside this region) is increased by one. Internal path cost (of paths within this region) is increased by one when BPDUs traverse the region.

Devices that belong to the same MST region are configured to have the same MSTP configuration identification settings. These include the following parameters:

- Name of the MST region
- Revision level as the unique number for the MST region
- VLAN-to-MST Instance mapping

13.10.3 MST Instance

An MST Instance (MSTI) is a spanning tree instance. VLANs can be configured to run on a specific MSTI. Each created MSTI is identified by a unique number (known as an MST ID) known internally to a region. Thus an MSTI does not span across MST regions.

The following figure shows an example where there are two MST regions. Regions 1 and 2 have two spanning tree instances.

Figure 124 MSTIs in Different Regions

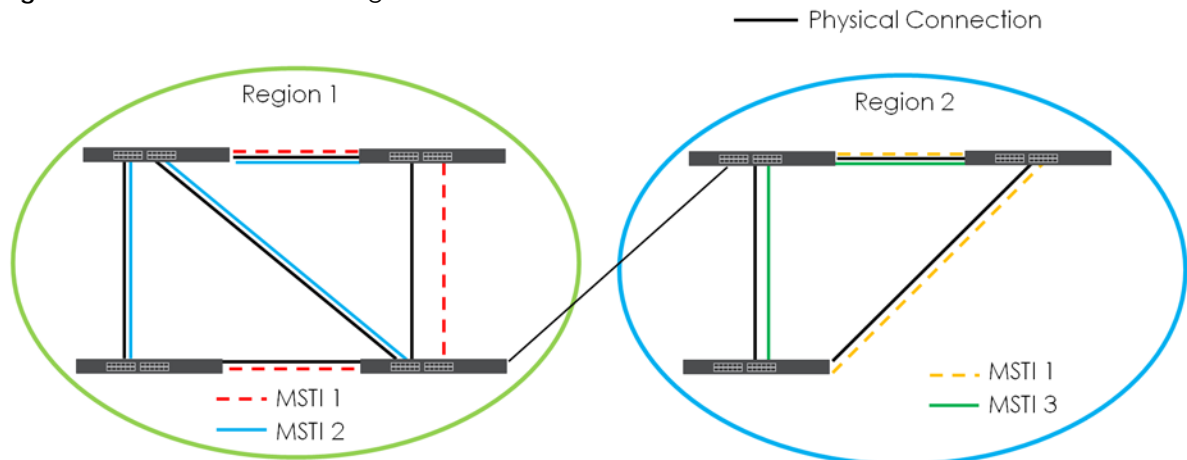

13.10.4 Common and Internal Spanning Tree (CIST)

A CIST represents the connectivity of the entire network and it is equivalent to a spanning tree in an STP/RSTP. The CIST is the default MST instance (MSTID 0). Any VLANs that are not members of an MST instance are members of the CIST. In an MSTP-enabled network, there is only one CIST that runs between MST regions and single spanning tree devices. A network may contain multiple MST regions and other network segments running RSTP.

Figure 125 MSTP and Legacy RSTP Network Example

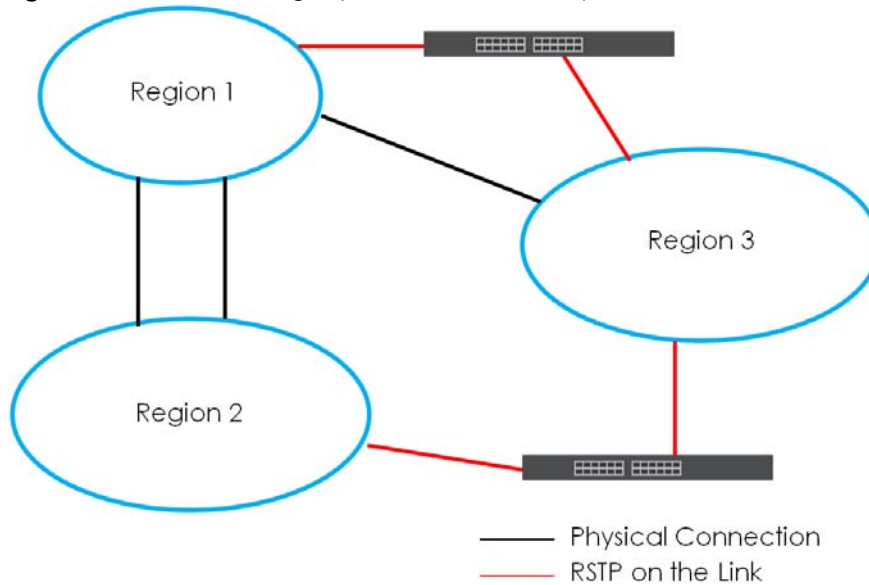

CHAPTER 14

Bandwidth Control

14.1 Bandwidth Control Overview

This chapter shows you how you can cap the maximum bandwidth using the **Bandwidth Control** screen.

Bandwidth control means defining a maximum allowable bandwidth for incoming and/or out-going traffic flows on a port.

14.1.1 What You Can Do

Use the **Bandwidth Control** screen ([Section 14.2 on page 165](#)) to limit the bandwidth for traffic going through the Switch.

14.2 Bandwidth Control Setup

Click **Advanced Application > Bandwidth Control** in the navigation panel to bring up the screen as shown next.

Figure 126 Advanced Application > Bandwidth Control

Port	Active	Ingress Rate	Active	Egress Rate
*	<input type="checkbox"/>		<input type="checkbox"/>	
1	<input checked="" type="checkbox"/>	64 kbps	<input type="checkbox"/>	64 kbps
2	<input checked="" type="checkbox"/>	64 kbps	<input type="checkbox"/>	64 kbps
3	<input checked="" type="checkbox"/>	64 kbps	<input type="checkbox"/>	64 kbps
4	<input checked="" type="checkbox"/>	64 kbps	<input type="checkbox"/>	64 kbps
5	<input checked="" type="checkbox"/>	64 kbps	<input type="checkbox"/>	64 kbps
6	<input checked="" type="checkbox"/>	64 kbps	<input type="checkbox"/>	64 kbps
7	<input checked="" type="checkbox"/>	64 kbps	<input type="checkbox"/>	64 kbps
8	<input checked="" type="checkbox"/>	64 kbps	<input type="checkbox"/>	64 kbps
9	<input checked="" type="checkbox"/>	64 kbps	<input type="checkbox"/>	64 kbps
10	<input checked="" type="checkbox"/>	64 kbps	<input type="checkbox"/>	64 kbps

The following table describes the related labels in this screen.

Table 63 Advanced Application > Bandwidth Control

LABEL	DESCRIPTION
Active	Select this check box to enable bandwidth control on the Switch.
Port	This field displays the port number.
*	<p>Settings in this row apply to all ports.</p> <p>Use this row only if you want to make some settings the same for all ports. Use this row first to set the common settings and then make adjustments on a port-by-port basis.</p> <p>Note: Changes in this row are copied to all the ports as soon as you make them.</p>
Active	Select this check box to activate ingress rate limits on this port.
Ingress Rate	<p>Specify the maximum bandwidth allowed in kilobits per second (Kbps) for the incoming traffic flow on a port.</p> <p>Note: Ingress rate bandwidth control applies to layer 2 traffic only.</p>
Active	Select this check box to activate egress rate limits on this port.
Egress Rate	Specify the maximum bandwidth allowed in kilobits per second (Kbps) for the out-going traffic flow on a port.
Apply	Click Apply to save your changes to the Switch's run-time memory. The Switch loses these changes if it is turned off or loses power, so use the Save link on the top navigation panel to save your changes to the non-volatile memory when you are done configuring.
Cancel	Click Cancel to reset the fields.

CHAPTER 15

Broadcast Storm Control

15.1 Broadcast Storm Control Overview

This chapter introduces and shows you how to configure the broadcast storm control feature.

Broadcast storm control limits the number of broadcast, multicast and destination lookup failure (DLF) packets the Switch receives per second on the ports. When the maximum number of allowable broadcast, multicast and/or DLF packets is reached per second, the subsequent packets are discarded. Enable this feature to reduce broadcast, multicast and/or DLF packets in your network. You can specify limits for each packet type on each port.

15.1.1 What You Can Do

Use the **Broadcast Storm Control** screen ([Section 15.2 on page 167](#)) to limit the number of broadcast, multicast and destination lookup failure (DLF) packets the Switch receives per second on the ports.

15.2 Broadcast Storm Control Setup

Click **Advanced Application** > **Broadcast Storm Control** in the navigation panel to display the screen as shown next.

Figure 127 Advanced Application > Broadcast Storm Control

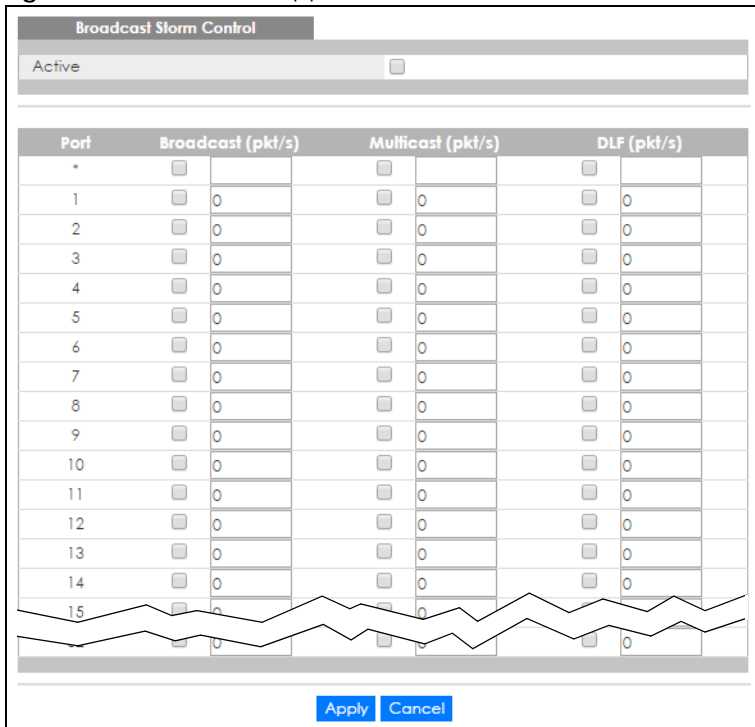

The following table describes the labels in this screen.

Table 64 Advanced Application > Broadcast Storm Control

LABEL	DESCRIPTION
Active	Select this check box to enable traffic storm control on the Switch. Clear this check box to disable this feature.
Port	This field displays the port number.
*	Settings in this row apply to all ports. Use this row only if you want to make some settings the same for all ports. Use this row first to set the common settings and then make adjustments on a port-by-port basis. Note: Changes in this row are copied to all the ports as soon as you make them.
Broadcast (pkt/s)	Select this option and specify how many broadcast packets the port receives per second.
Multicast (pkt/s)	Select this option and specify how many multicast packets the port receives per second.
DLF (pkt/s)	Select this option and specify how many destination lookup failure (DLF) packets the port receives per second.
Apply	Click Apply to save your changes to the Switch's run-time memory. The Switch loses these changes if it is turned off or loses power, so use the Save link on the top navigation panel to save your changes to the non-volatile memory when you are done configuring.
Cancel	Click Cancel to reset the fields.

CHAPTER 16

Mirroring

16.1 Mirroring Overview

This chapter discusses port mirroring setup screens.

Port mirroring allows you to copy a traffic flow to a monitor port (the port you copy the traffic to) in order that you can examine the traffic from the monitor port without interference.

16.2 Port Mirroring Setup

Click **Advanced Application > Mirroring** in the navigation panel to display the **Mirroring** screen. Use this screen to select a monitor port and specify the traffic flow to be copied to the monitor port.

Figure 128 Advanced Application > Mirroring

Port	Mirrored	Direction
*	<input type="checkbox"/>	Ingress ▾
1	<input type="checkbox"/>	Ingress ▾
2	<input type="checkbox"/>	Ingress ▾
3	<input type="checkbox"/>	Ingress ▾
4	<input type="checkbox"/>	Ingress ▾
5	<input type="checkbox"/>	Ingress ▾
6	<input type="checkbox"/>	Ingress ▾
7	<input type="checkbox"/>	Ingress ▾
8	<input type="checkbox"/>	Ingress ▾
9	<input type="checkbox"/>	Ingress ▾

The following table describes the labels in this screen.

Table 65 Advanced Application > Mirroring

LABEL	DESCRIPTION
Active	Select this check box to activate port mirroring on the Switch. Clear this check box to disable the feature.
Monitor Port	The monitor port is the port you copy the traffic to in order to examine it in more detail without interfering with the traffic flow on the original ports. Enter the port number of the monitor port.
Port	This field displays the port number.
*	<p>Settings in this row apply to all ports.</p> <p>Use this row only if you want to make some settings the same for all ports. Use this row first to set the common settings and then make adjustments on a port-by-port basis.</p> <p>Note: Changes in this row are copied to all the ports as soon as you make them.</p>
Mirrored	Select this option to mirror the traffic on a port.
Direction	Specify the direction of the traffic to mirror by selecting from the drop-down list box. Choices are Egress (outgoing), Ingress (incoming) and Both .
Apply	Click Apply to save your changes to the Switch's run-time memory. The Switch loses these changes if it is turned off or loses power, so use the Save link on the top navigation panel to save your changes to the non-volatile memory when you are done configuring.
Cancel	Click Cancel to reset the fields.

CHAPTER 17

Link Aggregation

17.1 Link Aggregation Overview

This chapter shows you how to logically aggregate physical links to form one logical, higher-bandwidth link.

Link aggregation (trunking) is the grouping of physical ports into one logical higher-capacity link. You may want to trunk ports if for example, it is cheaper to use multiple lower-speed links than to under-utilize a high-speed, but more costly, single-port link. However, the more ports you aggregate then the fewer available ports you have. A trunk group is one logical link containing multiple ports.

The beginning port of each trunk group must be physically connected to form a trunk group.

17.1.1 What You Can Do

- Use the **Link Aggregation Status** screen ([Section 17.2 on page 172](#)) to view ports you have configured to be in the trunk group, ports that are currently transmitting data as one logical link in the trunk group and so on.
- Use the **Link Aggregation Setting** screen ([Section 17.3 on page 173](#)) to configure static link aggregation.
- Use the **Link Aggregation Control Protocol** screen ([Section 17.3.1 on page 175](#)) to enable Link Aggregation Control Protocol (LACP).

17.1.2 What You Need to Know

The Switch supports both static and dynamic link aggregation.

Note: In a properly planned network, it is recommended to implement static link aggregation only. This ensures increased network stability and control over the trunk groups on your Switch.

See [Section 17.4.1 on page 177](#) for a static port trunking example.

Dynamic Link Aggregation

The Switch adheres to the IEEE 802.3ad standard for static and dynamic (LACP) port trunking.

The IEEE 802.3ad standard describes the Link Aggregation Control Protocol (LACP) for dynamically creating and managing trunk groups.

When you enable LACP link aggregation on a port, the port can automatically negotiate with the ports at the remote end of a link to establish trunk groups. LACP also allows port redundancy, that is, if an

operational port fails, then one of the “standby” ports become operational without user intervention. Please note that:

- You must connect all ports point-to-point to the same Ethernet switch and configure the ports for LACP trunking.
- LACP only works on full-duplex links.
- All ports in the same trunk group must have the same media type, speed, duplex mode and flow control settings.

Configure trunk groups or LACP before you connect the Ethernet switch to avoid causing network topology loops.

Link Aggregation ID

LACP aggregation ID consists of the following information¹:

Table 66 Link Aggregation ID: Local Switch

SYSTEM PRIORITY	MAC ADDRESS	KEY	PORT PRIORITY	PORT NUMBER
0000	00-00-00-00-00-00	0000	00	0000

Table 67 Link Aggregation ID: Peer Switch

SYSTEM PRIORITY	MAC ADDRESS	KEY	PORT PRIORITY	PORT NUMBER
0000	00-00-00-00-00-00	0000	00	0000

17.2 Link Aggregation Status

Click **Advanced Application > Link Aggregation** in the navigation panel. The **Link Aggregation Status** screen displays by default. See [Section 17.1 on page 171](#) for more information.

Figure 129 Advanced Application > Link Aggregation Status

Link Aggregation Status					Link Aggregation Setting
Group ID	Enabled Ports	Synchronized Ports	Aggregator ID	Criteria	Status
T1	-	-	-	src-dst-mac	-
T2	-	-	-	src-dst-mac	-
T3	-	-	-	src-dst-mac	-
T4	-	-	-	src-dst-mac	-
T5	-	-	-	src-dst-mac	-
T6	-	-	-	src-dst-mac	-
T7	-	-	-	src-dst-mac	-
T8	-	-	-	src-dst-mac	-
T9	-	-	-	src-dst-mac	-
T10	-	-	-	src-dst-mac	-
T11	-	-	-	src-dst-mac	-
T12	-	-	-	src-dst-mac	-
T13	-	-	-	src-dst-mac	-

1. Port Priority and Port Number are 0 as it is the aggregator ID for the trunk group, not the individual port.

The following table describes the labels in this screen.

Table 68 Advanced Application > Link Aggregation Status

LABEL	DESCRIPTION
Group ID	This field displays the group ID to identify a trunk group, that is, one logical link containing multiple ports.
Enabled Ports	These are the ports you have configured in the Link Aggregation screen to be in the trunk group. The port numbers displays only when this trunk group is activated and there is a port belonging to this group.
Synchronized Ports	These are the ports that are currently transmitting data as one logical link in this trunk group.
Aggregator ID	Link Aggregator ID consists of the following: system priority, MAC address, key, port priority and port number. The ID displays only when there is a port belonging to this trunk group and LACP is also enabled for this group.
Criteria	This shows the outgoing traffic distribution algorithm used in this trunk group. Packets from the same source and/or to the same destination are sent over the same link within the trunk. src-mac means the Switch distributes traffic based on the packet's source MAC address. dst-mac means the Switch distributes traffic based on the packet's destination MAC address. src-dst-mac means the Switch distributes traffic based on a combination of the packet's source and destination MAC addresses. src-ip means the Switch distributes traffic based on the packet's source IP address. dst-ip means the Switch distributes traffic based on the packet's destination IP address. src-dst-ip means the Switch distributes traffic based on a combination of the packet's source and destination IP addresses.
Status	This field displays how these ports were added to the trunk group. It displays: <ul style="list-style-type: none"> • Static – if the ports are configured as static members of a trunk group. • LACP – if the ports are configured to join a trunk group via LACP.

17.3 Link Aggregation Setting

Click **Advanced Application > Link Aggregation > Link Aggregation Setting** to display the screen shown next. See [Section 17.1 on page 171](#) for more information on link aggregation.

Figure 130 Advanced Application > Link Aggregation > Link Aggregation Setting

Link Aggregation Setting			Status	LACP
Group ID	Active	Criteria		
T1	<input type="checkbox"/>	src-dst-mac ▼		
T2	<input type="checkbox"/>	src-dst-mac ▼		
T3	<input type="checkbox"/>	src-dst-mac ▼		
T4	<input type="checkbox"/>	src-dst-mac ▼		
T5	<input type="checkbox"/>	src-dst-mac ▼		
T6	<input type="checkbox"/>	src-dst-mac ▼		
T7	<input type="checkbox"/>	src-dst-mac ▼		
T8	<input type="checkbox"/>	src-dst-mac ▼		
T9	<input type="checkbox"/>	src-dst-mac ▼		
T10	<input type="checkbox"/>	src-dst-mac ▼		
T11	<input type="checkbox"/>	src-dst-mac ▼		
T12	<input type="checkbox"/>	src-dst-mac ▼		
T13	<input type="checkbox"/>	src-dst-mac ▼		
T14	<input type="checkbox"/>	src-dst-mac ▼		
T15	<input type="checkbox"/>	src-dst-mac ▼		

Port	Group
1	None ▼
2	None ▼
3	None ▼
4	None ▼
5	None ▼
6	None ▼
7	None ▼
8	None ▼
9	None ▼
10	None ▼

The following table describes the labels in this screen.

Table 69 Advanced Application > Link Aggregation > Link Aggregation Setting

LABEL	DESCRIPTION
Link Aggregation Setting	This is the only screen you need to configure to enable static link aggregation.
Group ID	The field identifies the link aggregation group, that is, one logical link containing multiple ports.
Active	Select this option to activate a trunk group.

Table 69 Advanced Application > Link Aggregation > Link Aggregation Setting (continued)

LABEL	DESCRIPTION
Criteria	<p>Select the outgoing traffic distribution type. Packets from the same source and/or to the same destination are sent over the same link within the trunk. By default, the Switch uses the src-dst-mac distribution type. If the Switch is behind a router, the packet's destination or source MAC address will be changed. In this case, set the Switch to distribute traffic based on its IP address to make sure port trunking can work properly.</p> <p>Select src-mac to distribute traffic based on the packet's source MAC address.</p> <p>Select dst-mac to distribute traffic based on the packet's destination MAC address.</p> <p>Select src-dst-mac to distribute traffic based on a combination of the packet's source and destination MAC addresses.</p> <p>Select src-ip to distribute traffic based on the packet's source IP address.</p> <p>Select dst-ip to distribute traffic based on the packet's destination IP address.</p> <p>Select src-dst-ip to distribute traffic based on a combination of the packet's source and destination IP addresses.</p>
Port	This field displays the port number.
Group	<p>Select the trunk group to which a port belongs.</p> <p>Note: When you enable the port security feature on the Switch and configure port security settings for a port, you cannot include the port in an active trunk group.</p>
Apply	Click Apply to save your changes to the Switch's run-time memory. The Switch loses these changes if it is turned off or loses power, so use the Save link on the top navigation panel to save your changes to the non-volatile memory when you are done configuring.
Cancel	Click Cancel to begin configuring this screen afresh.

17.3.1 Link Aggregation Control Protocol

Click **Advanced Application > Link Aggregation > Link Aggregation Setting > LACP** to display the screen shown next. See [Dynamic Link Aggregation on page 171](#) for more information on dynamic link aggregation.

Figure 131 Advanced Application > Link Aggregation > Link Aggregation Setting > LACP

The screenshot shows the configuration interface for LACP. At the top, there's a header 'Link Aggregation Control Protocol' and a link 'Link Aggregation Setting'. Below this, there are two main sections. The first section contains a form with 'Active' (checkbox) and 'System Priority' (text box with value 65535). The second section is a table with columns 'Group ID' and 'LACP Active'. The 'Group ID' column lists T1 through T15, and the 'LACP Active' column has checkboxes, all of which are currently unchecked. Below this table is another table with columns 'Port' and 'LACP Timeout'. The 'Port' column lists ports 1 through 5, and the 'LACP Timeout' column has dropdown menus, all set to 30 seconds. At the bottom of the form are 'Apply' and 'Cancel' buttons.

The following table describes the labels in this screen.

Table 70 Advanced Application > Link Aggregation > Link Aggregation Setting > LACP

LABEL	DESCRIPTION
Link Aggregation Control Protocol	Note: Do NOT configure this screen unless you want to enable dynamic link aggregation.
Active	Select this check box to enable Link Aggregation Control Protocol (LACP).
System Priority	LACP system priority is a number between 1 and 65535. The switch with the lowest system priority (and lowest port number if system priority is the same) becomes the LACP "server". The LACP "server" controls the operation of LACP setup. Enter a number to set the priority of an active port using Link Aggregation Control Protocol (LACP). The smaller the number, the higher the priority level.
Group ID	The field identifies the link aggregation group, that is, one logical link containing multiple ports.
LACP Active	Select this option to enable LACP for a trunk.
Port	This field displays the port number.

Table 70 Advanced Application > Link Aggregation > Link Aggregation Setting > LACP (continued)

LABEL	DESCRIPTION
*	Settings in this row apply to all ports. Use this row only if you want to make some settings the same for all ports. Use this row first to set the common settings and then make adjustments on a port-by-port basis. Note: Changes in this row are copied to all the ports as soon as you make them.
LACP Timeout	Timeout is the time interval between the individual port exchanges of LACP packets in order to check that the peer port in the trunk group is still up. If a port does not respond after three tries, then it is deemed to be "down" and is removed from the trunk. Set a short timeout (1 second) for busy trunked links to ensure that disabled ports are removed from the trunk group as soon as possible. Select either 1 second or 30 seconds.
Apply	Click Apply to save your changes to the Switch's run-time memory. The Switch loses these changes if it is turned off or loses power, so use the Save link on the top navigation panel to save your changes to the non-volatile memory when you are done configuring.
Cancel	Click Cancel to begin configuring this screen afresh.

17.4 Technical Reference

This section provides technical background information on the topics discussed in this chapter.

17.4.1 Static Trunking Example

This example shows you how to create a static port trunk group for ports 2 – 5.

- 1 **Make your physical connections** – make sure that the ports that you want to belong to the trunk group are connected to the same destination. The following figure shows ports 2 – 5 on switch **A** connected to switch **B**.

Figure 132 Trunking Example – Physical Connections



- 2 **Configure static trunking** – Click **Advanced Application > Link Aggregation > Link Aggregation Setting**. In this screen activate trunk group **T1**, select the traffic distribution algorithm used by this group and select the ports that should belong to this group as shown in the figure below. Click **Apply** when you are done.

Figure 133 Trunking Example – Configuration Screen

Link Aggregation Setting
[Status](#) [LACP](#)

Group ID	Active	Criteria
T1	<input checked="" type="checkbox"/>	src-dst-mac ▼
T2	<input type="checkbox"/>	src-dst-mac ▼
T3	<input type="checkbox"/>	src-dst-mac ▼
T4	<input type="checkbox"/>	src-dst-mac ▼
T5	<input type="checkbox"/>	src-dst-mac ▼
T6	<input type="checkbox"/>	src-dst-mac ▼
T7	<input type="checkbox"/>	src-dst-mac ▼
T8	<input type="checkbox"/>	src-dst-mac ▼
T9	<input type="checkbox"/>	src-dst-mac ▼
T10	<input type="checkbox"/>	src-dst-mac ▼
T11	<input type="checkbox"/>	src-dst-mac ▼
T12	<input type="checkbox"/>	src-dst-mac ▼
T13	<input type="checkbox"/>	src-dst-mac ▼
T14	<input type="checkbox"/>	src-dst-mac ▼
T15	<input type="checkbox"/>	src-dst-mac ▼

Port	Group
1	None ▼
2	T1 ▼
3	T1 ▼
4	T1 ▼
5	T1 ▼
6	None ▼
7	None ▼
8	None ▼
9	None ▼

EXAMPLE

Apply Cancel

Your trunk group 1 (T1) configuration is now complete.

CHAPTER 18

Port Authentication

18.1 Port Authentication Overview

This chapter describes the IEEE 802.1x, MAC, and Guest VLAN authentication methods.

Port authentication is a way to validate access to ports on the Switch to clients based on an external server (authentication server). The Switch supports the following methods for port authentication:

- **IEEE 802.1x** – An authentication server validates access to a port based on a username and password provided by the user.
- **MAC Authentication** – An authentication server validates access to a port based on the MAC address and password of the client.
- **Guest VLAN** – A user that fails an authentication server can still access the port, but traffic from the user is forwarded to the guest VLAN port.

All types of authentication use the RADIUS (Remote Authentication Dial In User Service, RFC 2138, 2139) protocol to validate users.

Note: If you enable IEEE 802.1x authentication and MAC authentication on the same port, the Switch performs IEEE 802.1x authentication first. If a user fails to authenticate via the IEEE 802.1x method, then access to the port is denied.

18.1.1 What You Can Do

- Use the **Port Authentication** screen ([Section 18.2 on page 180](#)) to display the links to the configuration screens where you can enable the port authentication methods.
- Use the **802.1x** screen ([Section 18.3 on page 181](#)) to activate IEEE 802.1x security.
- Use the **MAC Authentication** screen ([Section 18.4 on page 182](#)) to activate MAC authentication.
- Use the **Guest Vlan** screen ([Section 18.5 on page 184](#)) to enable and assign a guest VLAN to a port.

18.1.2 What You Need to Know

IEEE 802.1x Authentication

The following figure illustrates how a client connecting to a IEEE 802.1x authentication enabled port goes through a validation process. The Switch prompts the client for login information in the form of a user name and password after the client responds to its identity request. When the client provides the login credentials, the Switch sends an authentication request to a RADIUS server. The RADIUS server validates whether this client is allowed access to the port.

Figure 134 IEEE 802.1x Authentication Process

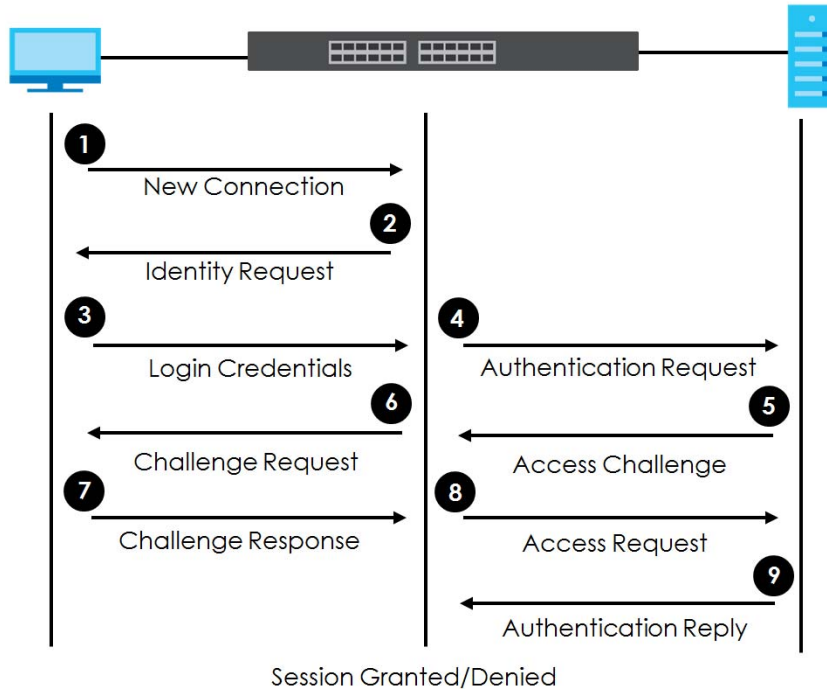

18.1.3 MAC Authentication

MAC authentication works in a very similar way to IEEE 802.1x authentication. The main difference is that the Switch does not prompt the client for login credentials. The login credentials are based on the source MAC address of the client connecting to a port on the Switch along with a password configured specifically for MAC authentication on the Switch.

Figure 135 MAC Authentication Process

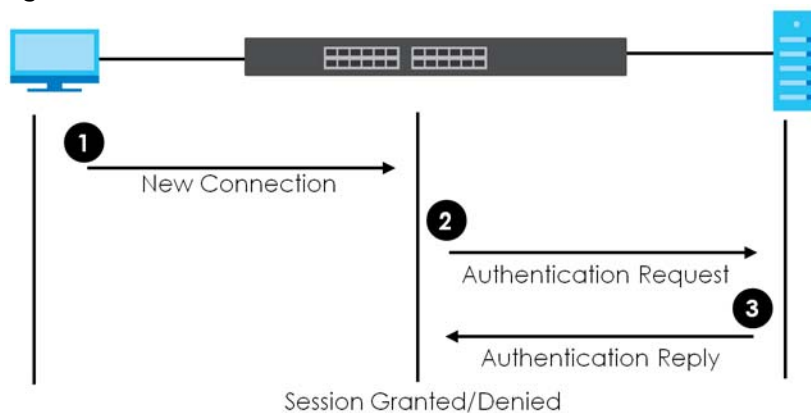

18.2 Port Authentication Configuration

To enable port authentication, first activate the port authentication methods (both on the Switch and the ports), then configure the RADIUS server settings in the **AAA > RADIUS Server Setup** screen.

Click **Advanced Application > Port Authentication** in the navigation panel to display the screen as shown. Select a port authentication method's link in the screen that appears.

Figure 136 Advanced Application > Port Authentication

Port Authentication	
802.1x	Click here
MAC Authentication	Click here
Guest Vlan	Click here

18.3 Activate IEEE 802.1x Security

Use this screen to activate IEEE 802.1x security. In the **Port Authentication** screen click **802.1x** to display the configuration screen as shown.

Figure 137 Advanced Application > Port Authentication > 802.1x

802.1x		Port Authentication									
Active		<input type="checkbox"/>									
Port	Active	Max-Req	Reauth	Reauth-period secs	Quiet-period secs	Tx-period secs	Supp-Timeout secs				
*	<input type="checkbox"/>		On ▼								
1	<input type="checkbox"/>	2	On ▼	3600	60	30	30				
2	<input type="checkbox"/>	2	On ▼	3600	60	30	30				
3	<input type="checkbox"/>	2	On ▼	3600	60	30	30				
4	<input type="checkbox"/>	2	On ▼	3600	60	30	30				
5	<input type="checkbox"/>	2	On ▼	3600	60	30	30				
6	<input type="checkbox"/>	2	On ▼	3600	60	30	30				
7	<input type="checkbox"/>	2	On ▼	3600	60	30	30				
8	<input type="checkbox"/>	2	On ▼	3600	60	30	30				
9	<input type="checkbox"/>	2	On ▼	3600	60	30	30				
10	<input type="checkbox"/>	2	On ▼	3600	60	30	30				
11	<input type="checkbox"/>	2	On ▼	3600	60	30	30				
12	<input type="checkbox"/>	2	On ▼	3600	60	30	30				
13	<input type="checkbox"/>	2	On ▼	3600	60	30	30				
14	<input type="checkbox"/>	2	On ▼	3600	60	30	30				
15	<input type="checkbox"/>	2	On ▼	3600	60	30	30				
16	<input type="checkbox"/>	2	On ▼	3600	60	30	30				
17	<input type="checkbox"/>	2	On ▼	3600	60	30	30				

The following table describes the labels in this screen.

Table 71 Advanced Application > Port Authentication > 802.1x

LABEL	DESCRIPTION
Active	Select this check box to permit 802.1x authentication on the Switch. Note: You must first enable 802.1x authentication on the Switch before configuring it on each port.
Port	This field displays the port number. * means all ports.
*	Settings in this row apply to all ports. Use this row only if you want to make some settings the same for all ports. Use this row first to set the common settings and then make adjustments on a port-by-port basis. Note: Changes in this row are copied to all the ports as soon as you make them.
Active	Select this to permit 802.1x authentication on this port. You must first allow 802.1x authentication on the Switch before configuring it on each port.
Max-Req	Specify the number of times the Switch tries to authenticate clients before sending unresponsive ports to the Guest VLAN. This is set to 2 by default. That is, the Switch attempts to authenticate a client twice. If the client does not respond to the first authentication request, the Switch tries again. If the client still does not respond to the second request, the Switch sends the client to the Guest VLAN. The client needs to send a new request to be authenticated by the Switch again.
Reauth	Specify if a subscriber has to periodically re-enter his or her username and password to stay connected to the port.
Reauth-period secs	Specify the length of time required to pass before a client has to re-enter his or her username and password to stay connected to the port.
Quiet-period secs	Specify the number of seconds the port remains in the HELD state and rejects further authentication requests from the connected client after a failed authentication exchange.
Tx-period secs	Specify the number of seconds the Switch waits for client's response before re-sending an identity request to the client.
Supp-Timeout secs	Specify the number of seconds the Switch waits for client's response to a challenge request before sending another request.
Apply	Click Apply to save your changes to the Switch's run-time memory. The Switch loses these changes if it is turned off or loses power, so use the Save link on the top navigation panel to save your changes to the non-volatile memory when you are done configuring.
Cancel	Click Cancel to begin configuring this screen afresh.

18.4 Activate MAC Authentication

Use this screen to activate MAC authentication. In the **Port Authentication** screen click **MAC Authentication** to display the configuration screen as shown.

Figure 138 Advanced Application > Port Authentication > MAC Authentication

Port	Active
*	<input type="checkbox"/>
1	<input type="checkbox"/>
2	<input type="checkbox"/>
3	<input type="checkbox"/>
4	<input type="checkbox"/>
5	<input type="checkbox"/>
6	<input type="checkbox"/>
7	<input type="checkbox"/>
8	<input type="checkbox"/>
9	<input type="checkbox"/>
10	<input type="checkbox"/>
11	<input type="checkbox"/>
48	<input type="checkbox"/>
49	<input type="checkbox"/>
50	<input type="checkbox"/>

The following table describes the labels in this screen.

Table 72 Advanced Application > Port Authentication > MAC Authentication

LABEL	DESCRIPTION
Active	Select this check box to permit MAC authentication on the Switch. Note: You must first enable MAC authentication on the Switch before configuring it on each port.
Name Prefix	Type the prefix that is appended to all MAC addresses sent to the RADIUS server for authentication. You can enter up to 32 printable ASCII characters. If you leave this field blank, then only the MAC address of the client is forwarded to the RADIUS server.
Delimiter	Select the delimiter the RADIUS server uses to separate the pairs in MAC addresses used as the account username (and password). You can select Dash (-) , Colon (:) , or None to use no delimiters at all in the MAC address.
Case	Select the case (Upper or Lower) the RADIUS server requires for letters in MAC addresses used as the account username (and password).
Password Type	Select Static to have the Switch send the password you specify below or MAC-Address to use the client MAC address as the password.
Password	Type the password the Switch sends along with the MAC address of a client for authentication with the RADIUS server. You can enter up to 32 printable ASCII characters.

Table 72 Advanced Application > Port Authentication > MAC Authentication (continued)

LABEL	DESCRIPTION
Timeout	Specify the amount of time before the Switch allows a client MAC address that fails authentication to try and authenticate again. Maximum time is 3000 seconds. When a client fails MAC authentication, its MAC address is learned by the MAC address table with a status of denied. The timeout period you specify here is the time the MAC address entry stays in the MAC address table until it is cleared. If you specify 0 for the timeout value, the Switch uses the Aging Time configured in the Switch Setup screen. Note: If the Aging Time in the Switch Setup screen is set to a lower value, then it supersedes this setting.
Port	This field displays a port number. * means all ports.
*	Use this row to make the setting the same for all ports. Use this row first and then make adjustments on a port-by-port basis. Note: Changes in this row are copied to all the ports as soon as you make them.
Active	Select this check box to permit MAC authentication on this port. You must first allow MAC authentication on the Switch before configuring it on each port.
Apply	Click Apply to save your changes to the Switch's run-time memory. The Switch loses these changes if it is turned off or loses power, so use the Save link on the top navigation panel to save your changes to the non-volatile memory when you are done configuring.
Cancel	Click Cancel to begin configuring this screen afresh.

18.5 Guest VLAN

When 802.1x port authentication is enabled on the Switch and its ports, clients that do not have the correct credentials are blocked from using the ports. You can configure your Switch to have one VLAN that acts as a guest VLAN. If you enable the guest VLAN (**102** in the example) on a port (**2** in the example), the user (**A** in the example) that is not IEEE 802.1x capable or fails to enter the correct username and password can still access the port, but traffic from the user is forwarded to the guest VLAN. That is, unauthenticated users can have access to limited network resources in the same guest VLAN, such as the Internet. The rights granted to the Guest VLAN depends on how the network administrator configures switches or routers with the guest network feature.

Figure 139 Guest VLAN Example

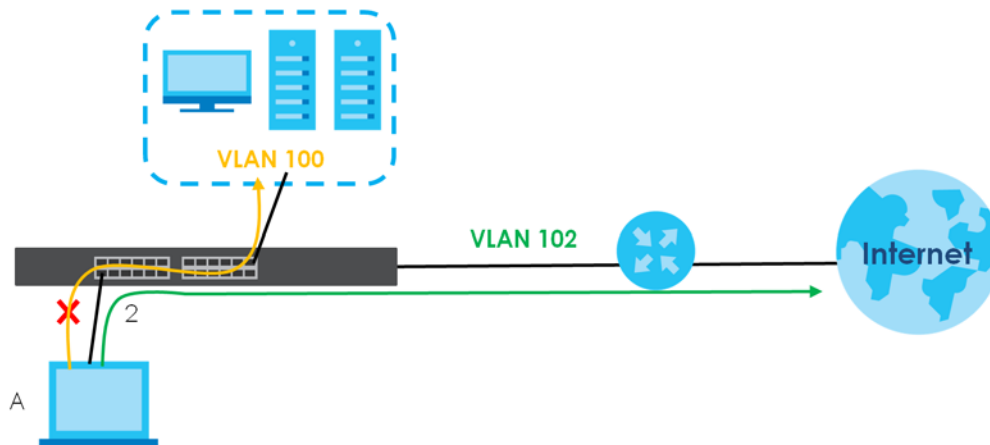

Use this screen to enable and assign a guest VLAN to a port. In the **Port Authentication** screen click **Guest VLAN** to display the configuration screen as shown.

Figure 140 Advanced Application > Port Authentication > Guest VLAN

Port	Active	Guest Vlan	Host-mode	Multi-Secure Num
*	<input type="checkbox"/>		Multi-Host	
1	<input type="checkbox"/>	1	Multi-Host	1
2	<input type="checkbox"/>	1	Multi-Host	1
3	<input type="checkbox"/>	1	Multi-Host	1
4	<input type="checkbox"/>	1	Multi-Host	1
5	<input type="checkbox"/>	1	Multi-Host	1
6	<input type="checkbox"/>	1	Multi-Host	1
7	<input type="checkbox"/>	1	Multi-Host	1
8	<input type="checkbox"/>	1	Multi-Host	1
9	<input type="checkbox"/>	1	Multi-Host	1
10	<input type="checkbox"/>	1	Multi-Host	1
11	<input type="checkbox"/>	1	Multi-Host	1
12	<input type="checkbox"/>	1	Multi-Host	1
13	<input type="checkbox"/>	1	Multi-Host	1
14	<input type="checkbox"/>	1	Multi-Host	1
15	<input type="checkbox"/>	1	Multi-Host	1
16	<input type="checkbox"/>	1	Multi-Host	1
17	<input type="checkbox"/>	1	Multi-Host	1
18	<input type="checkbox"/>	1	Multi-Host	1
19	<input type="checkbox"/>	1	Multi-Host	1
20	<input type="checkbox"/>	1	Multi-Host	1
21	<input type="checkbox"/>	1	Multi-Host	1
22	<input type="checkbox"/>	1	Multi-Host	1
23	<input type="checkbox"/>	1	Multi-Host	1
24	<input type="checkbox"/>	1	Multi-Host	1
25	<input type="checkbox"/>	1	Multi-Host	1
26	<input type="checkbox"/>	1	Multi-Host	1
27	<input type="checkbox"/>	1	Multi-Host	1

The following table describes the labels in this screen.

Table 73 Advanced Application > Port Authentication > Guest VLAN

LABEL	DESCRIPTION
Port	This field displays a port number. * means all ports.
*	Settings in this row apply to all ports. Use this row only if you want to make some settings the same for all ports. Use this row first to set the common settings and then make adjustments on a port-by-port basis. Changes in this row are copied to all the ports as soon as you make them.
Active	Select this check box to enable the guest VLAN feature on this port. Clients that fail authentication are placed in the guest VLAN and can receive limited services.
Guest Vlan	A guest VLAN is a pre-configured VLAN on the Switch that allows non-authenticated users to access limited network resources through the Switch. You must also enable IEEE 802.1x authentication on the Switch and the associated ports. Enter the number that identifies the guest VLAN. Make sure this is a VLAN recognized in your network.

Table 73 Advanced Application > Port Authentication > Guest VLAN (continued)

LABEL	DESCRIPTION
Host-mode	<p>Specify how the Switch authenticates users when more than one user connect to the port (using a hub).</p> <p>Select Multi-Host to authenticate only the first user that connects to this port. If the first user enters the correct credential, any other users are allowed to access the port without authentication. If the first user fails to enter the correct credential, they are all put in the guest VLAN. Once the first user who did authentication logs out or disconnects from the port, rest of the users are blocked until a user does the authentication process again.</p> <p>Select Multi-Secure to authenticate each user that connects to this port.</p>
Multi-Secure Num	If you set Host-mode to Multi-Secure , specify the maximum number of users (between 1 and 24) that the Switch will authenticate on this port.
Apply	Click Apply to save your changes to the Switch's run-time memory. The Switch loses these changes if it is turned off or loses power, so use the Save link on the top navigation panel to save your changes to the non-volatile memory when you are done configuring.
Cancel	Click Cancel to begin configuring this screen afresh.

18.6 Technical Reference

This section provides technical background information on the topics discussed in this chapter.

18.6.1 IEEE 802.1x

The IEEE 802.1x is a standard for authentication as well as providing additional accounting and control features. It can be implemented both on wired and wireless networks. It is supported by Windows XP and a number of network devices. Some advantages of IEEE 802.1x are:

- User based identification
- Support for RADIUS (Remote Authentication Dial In User Service, RFC 2138, 2139) for centralized user profile and accounting management on a network RADIUS server.
- Support for EAP (Extensible Authentication Protocol, RFC 2486) that allows additional authentication methods to be deployed with no changes to the switch or the wired clients.

18.6.2 RADIUS

RADIUS is based on a client-server model that supports authentication, authorization and accounting. The RADIUS server handles the following tasks:

- Authentication

Determines the identity of the users.

- Authorization

Determines the network services available to authenticated users once they are connected to the network.

- Accounting

Keeps track of the actions that are performed on the switch, such as login events.

RADIUS is a simple package exchange in which your switch acts as a message relay between the wired client and the network RADIUS server.

18.6.2.1 Types of RADIUS Messages

The following types of RADIUS messages are exchanged between the switch and the RADIUS server for user authentication:

- Access-Request

Sent by a switch requesting authentication.

- Access-Reject

Sent by a RADIUS server rejecting access.

- Access-Accept

Sent by a RADIUS server allowing access.

- Access-Challenge

Sent by a RADIUS server requesting more information in order to allow access. The switch sends a proper response from the user and then sends another Access-Request message.

The following types of RADIUS messages are exchanged between the switch and the RADIUS server for user accounting:

- Accounting-Request

Sent by the switch requesting accounting.

- Accounting-Response

Sent by the RADIUS server to indicate that it has started or stopped accounting.

The switch and the RADIUS server use a shared secret key, which is a password, they both know to authenticate the communications between them, and ensure network security. A shared key is not sent over the network.

The switch forwards the RADIUS requests of a client to the RADIUS server. The login password information exchanged is sent over the network and encrypted to protect the network from unauthorized access.

18.6.3 EAP (Extensible Authentication Protocol) Authentication

This section discusses some popular authentication types: EAP-MD5, EAP-TLS, EAP-TTLS, PEAP and LEAP. Your wired LAN device may not support all authentication types.

EAP (Extensible Authentication Protocol) is an authentication protocol that runs on top of the IEEE 802.1x transport mechanism in order to support multiple types of user authentication. By using EAP to interact with an EAP-compatible RADIUS server, a switch helps a wired station and a RADIUS server perform authentication.

The type of authentication you use depends on the RADIUS server and an intermediary switches that supports IEEE 802.1x.

For EAP-TLS authentication type, you must first have a wired connection to the network and obtain the certificates from a certificate authority (CA). A certificate (also called digital IDs) can be used to authenticate users and a CA issues certificates and guarantees the identity of each certificate owner.

- EAP-MD5 (Message-Digest Algorithm 5)

MD5 authentication is the simplest one-way authentication method. The authentication server sends a challenge to the wired client. The wired client 'proves' that it knows the password by encrypting the password with the challenge and sends back the information. Password is not sent in plain text.

However, MD5 authentication has some weaknesses. Since the authentication server needs to get the plaintext passwords, the passwords must be stored. Thus someone other than the authentication server may access the password file. In addition, it is possible to impersonate an authentication server as MD5 authentication method does not perform mutual authentication. Finally, MD5 authentication method does not support data encryption with dynamic session key. You must configure WEP encryption keys for data encryption.

- EAP-TLS (Transport Layer Security)

With EAP-TLS, digital certifications are needed by both the server and the wired clients for mutual authentication. The server presents a certificate to the client. After validating the identity of the server, the client sends a different certificate to the server. The exchange of certificates is done in the open before a secured tunnel is created. This makes user identity vulnerable to passive attacks. A digital certificate is an electronic ID card that authenticates the sender's identity. However, to implement EAP-TLS, you need a Certificate Authority (CA) to handle certificates, which imposes a management overhead.

- EAP-TTLS (Tunneled Transport Layer Service)

EAP-TTLS is an extension of the EAP-TLS authentication that uses certificates for only the server-side authentications to establish a secure connection. Client authentication is then done by sending username and password through the secure connection, thus client identity is protected. For client authentication, EAP-TTLS supports EAP methods and legacy authentication methods such as PAP, CHAP, MS-CHAP and MS-CHAP v2.

- PEAP (Protected EAP)

Like EAP-TTLS, server-side certificate authentication is used to establish a secure connection, then use simple username and password methods through the secured connection to authenticate the clients, thus hiding client identity. However, PEAP only supports EAP methods, such as EAP-MD5, EAP-MSCHAPv2 and EAP-GTC (EAP-Generic Token Card), for client authentication. EAP-GTC is implemented only by Cisco.

- LEAP

LEAP (Lightweight Extensible Authentication Protocol) is a Cisco implementation of IEEE 802.1x.

CHAPTER 19

Port Security

This chapter shows you how to set up port security.

19.1 About Port Security

Port security allows only packets with dynamically learned MAC addresses and/or configured static MAC addresses to pass through a port on the Switch. The Switch can learn up to 32K MAC addresses in total with no limit on individual ports other than the sum cannot exceed 32K.

For maximum port security, enable this feature, disable MAC address learning and configure static MAC addresses for a port. It is not recommended you disable port security together with MAC address learning as this will result in many broadcasts. By default, MAC address learning is still enabled even though the port security is not activated.

19.2 Port Security Setup

Click **Advanced Application > Port Security** in the navigation panel to display the screen as shown.

Figure 141 Advanced Application > Port Security

Port	Active	Address Learning	Limited Number of Learned MAC Address
*	<input type="checkbox"/>	<input checked="" type="checkbox"/>	
1	<input type="checkbox"/>	<input checked="" type="checkbox"/>	0
2	<input type="checkbox"/>	<input checked="" type="checkbox"/>	0
3	<input type="checkbox"/>	<input checked="" type="checkbox"/>	0
4	<input type="checkbox"/>	<input checked="" type="checkbox"/>	0
5	<input type="checkbox"/>	<input checked="" type="checkbox"/>	0
6	<input type="checkbox"/>	<input checked="" type="checkbox"/>	0
7	<input type="checkbox"/>	<input checked="" type="checkbox"/>	0
8	<input type="checkbox"/>	<input checked="" type="checkbox"/>	0
9	<input type="checkbox"/>	<input checked="" type="checkbox"/>	0

The following table describes the labels in this screen.

Table 74 Advanced Application > Port Security

LABEL	DESCRIPTION
Port List	Enter the number of the ports (separated by a comma) on which you want to enable port security and disable MAC address learning. After you click MAC freeze , all previously learned MAC addresses on the specified ports will become static MAC addresses and display in the Static MAC Forwarding screen.
MAC freeze	Click MAC freeze to have the Switch automatically select the Active check boxes and clear the Address Learning check boxes only for the ports specified in the Port List .
Active	Select this option to enable port security on the Switch.
Port	This field displays the port number.
*	Settings in this row apply to all ports. Use this row only if you want to make some of the settings the same for all ports. Use this row first to set the common settings and then make adjustments on a port-by-port basis. Note: Changes in this row are copied to all the ports as soon as you make them.
Active	Select this check box to enable the port security feature on this port. The Switch forwards packets whose MAC addresses is in the MAC address table on this port. Packets with no matching MAC addresses are dropped. Clear this check box to disable the port security feature. The Switch forwards all packets on this port.
Address Learning	MAC address learning reduces outgoing broadcast traffic. For MAC address learning to occur on a port, the port itself must be active with address learning enabled.
Limited Number of Learned MAC Address	Use this field to limit the number of (dynamic) MAC addresses that may be learned on a port. For example, if you set this field to "5" on port 2, then only the devices with these five learned MAC addresses may access port 2 at any one time. A sixth device must wait until one of the five learned MAC addresses ages out. MAC address aging out time can be set in the Switch Setup screen. The valid range is from "0" to "16K". "0" means this feature is disabled.
Apply	Click Apply to save your changes to the Switch's run-time memory. The Switch loses these changes if it is turned off or loses power, so use the Save link on the top navigation panel to save your changes to the non-volatile memory when you are done configuring.
Cancel	Click Cancel to begin configuring this screen afresh.

CHAPTER 20

Time Range

20.1 Time Range Overview

You can set up one-time and recurring schedules for time-oriented features, such as PoE and classifier. The UAG supports one-time and recurring schedules. One-time schedules are effective only once, while recurring schedules usually repeat. Both types of schedules are based on the current date and time in the Switch.

20.1.1 What You Can Do

Use the **Time Range** screen ([Section 20.2 on page 191](#)) to view or define a schedule on the Switch.

20.2 Configuring Time Range

Click **Advanced Application > Time Range** in the navigation panel to display the screen as shown.

Figure 142 Advanced Application > Time Range

Index	Name	Type	Range

The following table describes the labels in this screen.

Table 75 Advanced Application > Time Range

LABEL	DESCRIPTION
Name	Enter a descriptive name for this rule for identifying purposes.
Type	Select Absolute to create a one-time schedule. One-time schedules begin on a specific start date and time and end on a specific stop date and time. One-time schedules are useful for long holidays and vacation periods. Alternatively, select Periodic to create a recurring schedule. Recurring schedules begin at a specific start time and end at a specific stop time on selected days of the week (Sunday, Monday, Tuesday, Wednesday, Thursday, Friday, and Saturday). Recurring schedules are useful for defining the workday and off-work hours.
Absolute	This section is available only when you set Type to Absolute .
Start	Specify the year, month, day, hour and minute when the schedule begins.
End	Specify the year, month, day, hour and minute when the schedule ends.
Periodic	This section is available only when you set Type to Periodic . Select the first option if you want to define a recurring schedule for a consecutive time period. You then select the day of the week, hour and minute when the schedule begins and ends respectively. Select the second option if you want to define a recurring schedule for multiple non-consecutive time periods. You need to select each day of the week the recurring schedule is effective. You also need to specify the hour and minute when the schedule begins and ends each day. The schedule begins and ends in the same day.
Add	Click Add to save your changes to the Switch's run-time memory. The Switch loses these changes if it is turned off or loses power, so use the Save link on the top navigation panel to save your changes to the non-volatile memory when you are done configuring.
Cancel	Click Cancel to reset the fields to your previous configuration.
Clear	Click Clear to clear the fields to the factory defaults.
Index	This field displays the index number of the rule. Click an index number to change the settings.
Name	This field displays the descriptive name for this rule. This is for identification purpose only.
Type	This field displays the type of the schedule.
Range	This field displays the time periods to which this schedule applies.
	Select an entry's check box to select a specific entry. Otherwise, select the check box in the table heading row to select all entries.
Delete	Check the rules that you want to remove and then click the Delete button.
Cancel	Click Cancel to clear the selected check boxes.

CHAPTER 21

Classifier

21.1 Classifier Overview

This chapter introduces and shows you how to configure the packet classifier on the Switch. It also discusses Quality of Service (QoS) and classifier concepts as employed by the Switch.

21.1.1 What You Can Do

- Use the **Classifier Status** screen ([Section 21.2 on page 194](#)) to view the classifiers configured on the Switch and how many times the traffic matches the rules.
- Use the **Classifier Configuration** screen ([Section 21.3 on page 194](#)) to define the classifiers and view a summary of the classifier configuration. After you define the classifier, you can specify actions (or policy) to act upon the traffic that matches the rules.
- Use the **Classifier Global Setting** screen ([Section 21.4 on page 199](#)) to configure the match order and enable logging on the Switch.

21.1.2 What You Need to Know

Quality of Service (QoS) refers to both a network's ability to deliver data with minimum delay, and the networking methods used to control the use of bandwidth. Without QoS, all traffic data is equally likely to be dropped when the network is congested. This can cause a reduction in network performance and make the network inadequate for time-critical application such as video-on-demand.

A classifier groups traffic into data flows according to specific criteria such as the source address, destination address, source port number, destination port number or incoming port number. For example, you can configure a classifier to select traffic from the same protocol port (such as Telnet) to form a flow.

Configure QoS on the Switch to group and prioritize application traffic and fine-tune network performance. Setting up QoS involves two separate steps:

- 1 Configure classifiers to sort traffic into different flows.
- 2 Configure policy rules to define actions to be performed on a classified traffic flow (refer to [Chapter 22 on page 202](#) to configure policy rules).

21.2 Classifier Status

Use this screen to view the classifiers configured on the Switch and how many times the traffic matches the rules.

Click **Advanced Application > Classifier** in the navigation panel to display the configuration screen as shown.

Figure 143 Advanced Application > Classifier > Classifier Status

Classifier Status					Classifier Configuration
Index	Active	Weight	Name	Match Count	Rule
1	No	32767	Class1	-	vlan 1;

Any
 Classifier

The following table describes the labels in this screen.

Table 76 Advanced Application > Classifier > Classifier Status

LABEL	DESCRIPTION
Index	This field displays the index number of the rule. Click an index number to edit the rule.
Active	This field displays Yes when the rule is activated and No when it is deactivated.
Weight	This field displays the rule's weight. This is to indicate a rule's priority when the match order is set to manual in the Classifier > Classifier Configuration > Classifier Global Setting screen. The higher the number, the higher the rule's priority.
Name	This field displays the descriptive name for this rule. This is for identification purpose only.
Match Count	This field displays the number of times a rule is applied. It displays '-' if the rule does not have count enabled.
Rule	This field displays a summary of the classifier rule's settings.
Any	Select Any , then click Clear to clear the matched count for all classifiers.
Classifier	Select Classifier , enter a classifier rule name and then click Clear to erase the recorded statistical information for that classifier, or select Any to clear statistics for all classifiers.
Clear	Select Classifier , enter a classifier rule name and then click Clear to erase the recorded statistical information for the classifier, or select Any to clear statistics for all classifiers.

21.3 Classifier Configuration

Use the **Classifier Configuration** screen to define the classifiers. After you define the classifier, you can specify actions (or policy) to act upon the traffic that matches the rules.

In the **Classifier Status** screen click **Classifier Configuration** to display the configuration screen as shown.

Figure 144 Advanced Application > Classifier > Classifier Configuration

Classifier Configuration
[Classifier Status](#) [Classifier Global Setting](#)

Active	<input type="checkbox"/>		
Name	<input type="text"/>		
Weight	<input type="text" value="32767"/>		
Log	<input type="checkbox"/>		
Count	<input type="checkbox"/>		
Time Range	None ▾		
Ingress Port	Port	<input checked="" type="radio"/> Any <input type="radio"/> <input type="text"/>	
	Trunk	<input checked="" type="radio"/> Any <input type="radio"/> <input type="text"/>	
Layer 2	VLAN	VLAN	<input checked="" type="radio"/> Any <input type="radio"/> <input type="text"/>
	Priority	Priority	<input checked="" type="radio"/> Any <input type="radio"/> 0 ▾
	Ethernet Type	<input checked="" type="radio"/> All ▾ <input type="radio"/> Others <input type="text"/> (Hex)	
	Source	MAC Address	<input checked="" type="radio"/> Any <input type="radio"/> MAC <input type="text"/> /Mask <input type="text"/>
	Destination	MAC Address	<input checked="" type="radio"/> Any <input type="radio"/> MAC <input type="text"/> /Mask <input type="text"/>
Layer 3	DSCP	IPv4	<input checked="" type="radio"/> Any <input type="radio"/> <input type="text"/>
		IPv6	<input checked="" type="radio"/> Any <input type="radio"/> <input type="text"/>
	Precedence	<input checked="" type="radio"/> Any <input type="radio"/> <input type="text"/>	
	ToS	<input checked="" type="radio"/> Any <input type="radio"/> <input type="text"/>	
	IP Protocol	<input checked="" type="radio"/> All ▾ <input type="checkbox"/> Establish Only <input type="radio"/> Others <input type="text"/> (Dec)	
	IPv6 Next Header	<input checked="" type="radio"/> All ▾ <input type="checkbox"/> Establish Only <input type="radio"/> Others <input type="text"/> (Dec)	
	Source	IP Address / Address Prefix	<input type="text"/> / <input type="text"/>
	Destination	IP Address / Address Prefix	<input type="text"/> / <input type="text"/>
Layer 4	Source	Socket Number	<input checked="" type="radio"/> Any <input type="radio"/> <input type="text"/> To <input type="text"/>
	Destination	Socket Number	<input checked="" type="radio"/> Any <input type="radio"/> <input type="text"/> To <input type="text"/>

Add
Cancel
Clear

Index	Active	Weight	Name	Rule
1	Yes	32767	Example	SrcMac = 00:50:ba:ad:4f:81;

Delete
Cancel

The following table describes the labels in this screen.

Table 77 Advanced Application > Classifier > Classifier Configuration

LABEL	DESCRIPTION
Active	Select this option to enable this rule.
Name	Enter a descriptive name for this rule for identifying purposes.
Weight	Enter a number between 0 and 65535 to specify the rule's weight. When the match order is in manual mode in the Classifier Global Setting screen, a higher weight means a higher priority.
Log	Select this option to have the Switch create a log message when the rule is applied and record the number of matched packets in a particular time interval. Note: Make sure you also enable logging in the Classifier Global Setting screen.
Count	Select this option to have the Switch count how many times the rule is applied.
Time Range	Select the name of the pre-configured schedule that you want to apply to the rule. The rule will be active only at the scheduled date and/or time. If you select None , the rule will be active all the time.
Ingress Port	
Port	Type the port number to which the rule should be applied. You may choose one port only or all ports (Any).
Trunk	Select Any to apply the rule to all trunk groups. To specify a trunk group, select the second choice and type a trunk group ID.
Layer 2 Specify the fields below to configure a layer 2 classifier.	
VLAN	
VLAN	Select Any to classify traffic from any VLAN or select the second option and specify the source VLAN ID in the field provided.
Priority	
Priority	Select Any to classify traffic from any priority level or select the second option and specify a priority level in the field provided.
Ethernet Type	Select an Ethernet type or select Other and enter the Ethernet type number in hexadecimal value.
Source	
MAC Address	Select Any to apply the rule to all MAC addresses. To specify a source, select MAC/Mask to enter the source MAC address of the packet in valid MAC address format (six hexadecimal character pairs) and type the mask for the specified MAC address to determine which bits a packet's MAC address should match. Enter "f" for each bit of the specified MAC address that the traffic's MAC address should match. Enter "0" for the bits of the matched traffic's MAC address, which can be of any hexadecimal characters. For example, if you set the MAC address to 00:13:49:00:00:00 and the mask to ff:ff:ff:00:00:00, a packet with a MAC address of 00:13:49:12:34:56 matches this criteria. If you leave the Mask field blank, the Switch automatically sets the mask to ff:ff:ff:ff:ff:ff.
Destination	

Table 77 Advanced Application > Classifier > Classifier Configuration (continued)

LABEL	DESCRIPTION
MAC Address	<p>Select Any to apply the rule to all MAC addresses.</p> <p>To specify a destination, select MAC/Mask to enter the destination MAC address of the packet in valid MAC address format (six hexadecimal character pairs) and type the mask for the specified MAC address to determine which bits a packet's MAC address should match.</p> <p>Enter "f" for each bit of the specified MAC address that the traffic's MAC address should match. Enter "0" for the bits of the matched traffic's MAC address, which can be of any hexadecimal characters. For example, if you set the MAC address to 00:13:49:00:00:00 and the mask to ff:ff:ff:00:00:00, a packet with a MAC address of 00:13:49:12:34:56 matches this criteria. If you leave the Mask field blank, the Switch automatically sets the mask to ff:ff:ff:ff:ff:ff.</p>
<p>Layer 3</p> <p>Specify the fields below to configure a layer 3 classifier.</p>	
DSCP IPv4/IPv6	<p>Select Any to classify traffic from any DSCP or select the second option and specify a DSCP (DiffServ Code Point) number between 0 and 63 in the field provided.</p>
Precedence	<p>Select Any to classify traffic from any precedence or select the second option and specify an IP Precedence (the first 3 bits of the 8-bit ToS field) value between 0 and 7 in the field provided.</p>
ToS	<p>Select Any to classify traffic from any ToS or select the second option and specify Type of Service (the last 5 bits of the 8-bit ToS field) value between 0 and 255 in the field provided.</p>
IP Protocol	<p>Select an IPv4 protocol type or select Other and enter the protocol number in decimal value.</p> <p>You may select Establish Only for TCP protocol type. This means that the Switch will pick out the packets that are sent to establish TCP connections.</p>
IPv6 Next Header	<p>Select an IPv6 protocol type or select Other and enter an 8-bit next header in the IPv6 packet. The Next Header field is similar to the IPv4 Protocol field. The IPv6 protocol number ranges from 1 to 255.</p> <p>You may select Establish Only for TCP protocol type. This means that the Switch will identify packets that initiate or acknowledge (establish) TCP connections.</p>
Source	
IP Address/Address Prefix	<p>Enter a source IP address in dotted decimal notation.</p> <p>Specify the address prefix by entering the number of ones in the subnet mask.</p> <p>A subnet mask can be represented in a 32-bit notation. For example, the subnet mask "255.255.255.0" can be represented as "11111111.11111111.11111111.00000000", and counting up the number of ones in this case results in 24.</p>
Destination	
IP Address/Address Prefix	<p>Enter a destination IP address in dotted decimal notation.</p> <p>Specify the address prefix by entering the number of ones in the subnet mask.</p>
<p>Layer 4</p> <p>Specify the fields below to configure a layer 4 classifier.</p>	
Source	
Socket Number	<p>Note: You must select either UDP or TCP in the IP Protocol field before you configure the socket numbers.</p> <p>Select Any to apply the rule to all TCP/UDP protocol port numbers or select the second option and enter a TCP/UDP protocol port number.</p>
Destination	

Table 77 Advanced Application > Classifier > Classifier Configuration (continued)

LABEL	DESCRIPTION
Socket Number	Note: You must select either UDP or TCP in the IP Protocol field before you configure the socket numbers. Select Any to apply the rule to all TCP/UDP protocol port numbers or select the second option and enter a TCP/UDP protocol port number.
Add	Click this to create a new entry or to update an existing one. This saves your changes to the Switch's run-time memory. The Switch loses these changes if it is turned off or loses power, so use the Save link on the top navigation panel to save your changes to the non-volatile memory when you are done configuring.
Cancel	Click Cancel to reset the fields back to your previous configuration.
Clear	Click Clear to set the above fields back to the factory defaults.

21.3.1 Viewing and Editing Classifier Configuration Summary

To view a summary of the classifier configuration, scroll down to the summary table at the bottom of the **Classifier** screen. To change the settings of a rule, click a number in the **Index** field.

Note: When two rules conflict with each other, a higher layer rule has priority over lower layer rule.

Figure 145 Advanced Application > Classifier > Classifier Configuration: Summary Table

Index	Active	Weight	Name	Rule	<input type="checkbox"/>
1	Yes	32767	rate limit v10	vlan 10; count;	<input type="checkbox"/>
2	Yes	32767	rate limit v20	vlan 20; count;	<input type="checkbox"/>
3	Yes	32767	rate limit v30	vlan 30; count;	<input type="checkbox"/>
4	Yes	32767	rate limit v40	vlan 40; count;	<input type="checkbox"/>

The following table describes the labels in this screen.

Table 78 Advanced Application > Classifier > Classifier Configuration: Summary Table

LABEL	DESCRIPTION
Index	This field displays the index number of the rule. Click an index number to edit the rule.
Active	This field displays Yes when the rule is activated and No when it is deactivated.
Weight	The field displays the priority of the rule when the match order is in manual mode. A higher weight means a higher priority.
Name	This field displays the descriptive name for this rule. This is for identification purpose only.
Rule	This field displays a summary of the classifier rule's settings.
	Select an entry's check box to select a specific entry. Otherwise, select the check box in the table heading row to select all entries.
Delete	Click Delete to remove the selected entry from the summary table.
Cancel	Click Cancel to clear the check boxes.

The following table shows some other common Ethernet types and the corresponding protocol number.

Table 79 Common Ethernet Types and Protocol Numbers

ETHERNET TYPE	PROTOCOL NUMBER
IP ETHII	0800
X.75 Internet	0801
NBS Internet	0802
ECMA Internet	0803
Chaosnet	0804
X.25 Level 3	0805
XNS Compat	0807
Banyan Systems	0BAD
BBN Simnet	5208
IBM SNA	80D5
AppleTalk AARP	80F3

In the Internet Protocol there is a field, called "Protocol", to identify the next level protocol. The following table shows some common protocol types and the corresponding protocol number. Refer to <http://www.iana.org/assignments/protocol-numbers> for a complete list.

Table 80 Common IP Protocol Types and Protocol Numbers

PROTOCOL TYPE	PROTOCOL NUMBER
ICMP	1
TCP	6
UDP	17
EGP	8
L2TP	115

Some of the most common TCP and UDP port numbers are:

Table 81 Common TCP and UDP Port Numbers

PROTOCOL NAME	TCP/UDP PORT NUMBER
FTP	21
Telnet	23
SMTP	25
DNS	53
HTTP	80
POP3	110

21.4 Classifier Global Setting Configuration

Use this screen to configure the match order and enable logging on the Switch. In the **Classifier Configuration** screen click **Classifier Global Setting** to display the configuration screen as shown.

Figure 146 Advanced Application > Classifier > Classifier Configuration > Classifier Global Setting

Classifier Global Setting		Classifier Configuration
Match Order	auto	
Logging	Active	<input checked="" type="checkbox"/>
	Interval	3600 Second(s)
		Apply Cancel

The following table describes the labels in this screen.

Table 82 Advanced Application > Classifier > Classifier Configuration > Classifier Global Setting

LABEL	DESCRIPTION
Match Order	Select manual to have classifier rules applied according to the weight of each rule you configured in Advanced Application > Classifier > Classifier Configuration . Alternatively, select auto to have classifier rules applied according to the layer of the item configured in the rule. Layer-4 items have the highest priority, and layer-2 items has the lowest priority. For example, you configure a layer-2 item (VLAN ID) in classifier A and configure a layer-3 item (source IP address) in classifier B. When an incoming packet matches both classifier rules, classifier B has priority over classifier A.
Logging	
Active	Select this to allow the Switch to create a log when packets match a classifier rule during a defined time interval.
Interval	Select the length of the time period (in seconds) to count matched packets for a classifier rule. Enter an integer from 0 – 65535. 0 means that no logging is done.
Apply	Click Apply to save your changes to the Switch's run-time memory. The Switch loses these changes if it is turned off or loses power, so use the Save link on the top navigation panel to save your changes to the non-volatile memory when you are done configuring.
Cancel	Click Cancel to begin configuring this screen afresh.

21.5 Classifier Example

The following screen shows an example where you configure a classifier that identifies all traffic from MAC address 00:50:ba:ad:4f:81 on port 2.

Figure 147 Classifier: Example

Classifier Configuration		Classifier Status	Classifier Global Setting
Active	<input checked="" type="checkbox"/>		
Name	example		
Weight	32767		
Log	<input type="checkbox"/>		
Count	<input type="checkbox"/>		
Time Range	None ▾		
Ingress Port	Port	<input type="radio"/> Any <input checked="" type="radio"/> 2	
	Trunk	<input checked="" type="radio"/> Any <input type="radio"/>	
Layer 2	VLAN	<input checked="" type="radio"/> Any <input type="radio"/>	
	Priority	<input checked="" type="radio"/> Any <input type="radio"/> 0 ▾	
	Ethernet Type	<input checked="" type="radio"/> All ▾ <input type="radio"/> Others (Hex)	
	Source	<input type="radio"/> Any <input checked="" type="radio"/> MAC 00:50:ba:ad:4f:81 <input type="radio"/> /Mask	
	Destination	<input type="radio"/> Any <input type="radio"/> MAC <input type="radio"/> /Mask	
Layer 3	DSCP	IPv4	<input checked="" type="radio"/> Any <input type="radio"/>
		IPv6	<input checked="" type="radio"/> Any <input type="radio"/>
	Precedence	<input checked="" type="radio"/> Any <input type="radio"/>	
	ToS	<input checked="" type="radio"/> Any <input type="radio"/>	
	IP Protocol	<input checked="" type="radio"/> All ▾ <input type="checkbox"/> Establish Only <input type="radio"/> Others (Dec)	
	IPv6 Next Header	<input checked="" type="radio"/> All ▾ <input type="checkbox"/> Establish Only <input type="radio"/> Others (Dec)	
	Source	IP Address / Address Prefix	
Destination	IP Address / Address Prefix		
Layer 4	Source	<input checked="" type="radio"/> Any <input type="radio"/> To	
	Destination	<input checked="" type="radio"/> Any <input type="radio"/> To	

EXAMPLE

Add Cancel Clear

After you have configured a classifier, you can configure a policy (in the **Policy** screen) to define actions on the classified traffic flow.

CHAPTER 22

Policy Rule

22.1 Policy Rules Overview

This chapter shows you how to configure policy rules.

A classifier distinguishes traffic into flows based on the configured criteria (refer to [Chapter 21 on page 193](#) for more information). A policy rule ensures that a traffic flow gets the requested treatment in the network.

22.1.1 What You Can Do

Use the **Policy Rule** screen ([Section 22.2 on page 203](#)) to enable the policy and display the active classifiers you configure in the **Classifier** screen.

22.1.2 DiffServ

DiffServ (Differentiated Services) is a class of service (CoS) model that marks packets so that they receive specific per-hop treatment at DiffServ-compliant network devices along the route based on the application types and traffic flow. Packets are marked with DiffServ Code Points (DSCPs) indicating the level of service desired. This allows the intermediary DiffServ-compliant network devices to handle the packets differently depending on the code points without the need to negotiate paths or remember state information for every flow. In addition, applications do not have to request a particular service or give advanced notice of where the traffic is going.

22.1.3 DSCP and Per-Hop Behavior

DiffServ defines a new DS (Differentiated Services) field to replace the Type of Service (TOS) field in the IP header. The DS field contains a 2-bit unused field and a 6-bit DSCP field which can define up to 64 service levels. The following figure illustrates the DS field.

DSCP is backward compatible with the three precedence bits in the ToS octet so that non-DiffServ compliant, ToS-enabled network device will not conflict with the DSCP mapping.

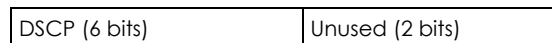

The DSCP value determines the forwarding behavior, the PHB (Per-Hop Behavior), that each packet gets across the DiffServ network. Based on the marking rule, different kinds of traffic can be marked for different kinds of forwarding. Resources can then be allocated according to the DSCP values and the configured policies.

22.2 Configuring Policy Rules

You must first configure a classifier in the **Classifier** screen.

Click **Advanced Application > Policy Rule** in the navigation panel to display the screen as shown.

Figure 148 Advanced Application > Policy Rule

The screenshot shows the 'Policy Rule' configuration interface. It includes a 'Policy' section with an 'Active' checkbox, a 'Name' text field, and a 'Classifier(s)' dropdown menu. The 'Parameters' section is split into 'General' (VLAN ID, Egress Port, Priority) and 'Rate Limit' (Bandwidth, Rate Limit). The 'Action' section contains 'Forwarding' (No change, Discard the packet), 'Priority' (No change, Set the packet's 802.1p priority), 'Outgoing' (Send the packet to the mirror port, Send the packet to the egress port, Set the packet's VLAN ID), and 'Rate Limit' (Enable). At the bottom, there are buttons for 'Add', 'Cancel', 'Clear', 'Delete', and 'Cancel', and a table with columns for 'Index', 'Active', 'Name', and 'Classifier(s)'.

The following table describes the labels in this screen.

Table 83 Advanced Application > Policy Rule

LABEL	DESCRIPTION
Active	Select this option to enable the policy.
Name	Enter a descriptive name for identification purposes.
Classifier(s)	This field displays the active classifiers you configure in the Classifier screen. Select the classifiers to which this policy rule applies. To select more than one classifier, press [SHIFT] and select the choices at the same time.
Parameters	Set the fields below for this policy. You only have to set the fields that is related to the actions you configure in the Action field.
General	
VLAN ID	Specify a VLAN ID.
Egress Port	Type the number of an outgoing port.
Priority	Specify a priority level.

Table 83 Advanced Application > Policy Rule (continued)

LABEL	DESCRIPTION
Rate Limit	You can configure the desired bandwidth available to a traffic flow. Traffic that exceeds the maximum bandwidth allocated (in cases where the network is congested) is called out-of-profile traffic.
Bandwidth	Specify the bandwidth in kilobit per second (kbps). Enter a number between 1 and 1000000.
Action	<p>Specify the actions the Switch takes on the associated classified traffic flow.</p> <p>Note: You can specify only one action (pair) in a policy rule. To have the Switch take multiple actions on the same traffic flow, you need to define multiple classifiers with the same criteria and apply different policy rules.</p> <p>Say you have several classifiers that identify the same traffic flow and you specify a different policy rule for each. If their policy actions conflict (Discard the packet, Send the packet to the egress port and Rate Limit), the Switch only applies the policy rules with the Discard the packet and Send the packet to the egress port actions depending on the classifier names. The longer the classifier name, the higher the classifier priority. If two classifier names are the same length, the bigger the character, the higher the classifier priority. The lowercase letters (such as a and b) have higher priority than the capitals (such as A and B) in the classifier name. For example, the classifier with the name of class 2, class a or class B takes priority over the classifier with the name of class 1 or class A.</p> <p>Let's say you set two classifiers (Class 1 and Class 2) and both identify all traffic from MAC address 11:22:33:44:55:66 on port 3.</p> <p>If Policy 1 applies to Class 1 and the action is to drop the packets, Policy 2 applies to Class 2 and the action is to forward the packets to the egress port, the Switch will forward the packets.</p> <p>If Policy 1 applies to Class 1 and the action is to drop the packets, Policy 2 applies to Class 2 and the action is to enable bandwidth limitation, the Switch will discard the packets immediately.</p> <p>If Policy 1 applies to Class 1 and the action is to forward the packets to the egress port, Policy 2 applies to Class 2 and the action is to enable bandwidth limitation, the Switch will forward the packets.</p>
Forwarding	<p>Select No change to forward the packets.</p> <p>Select Discard the packet to drop the packets.</p>
Priority	<p>Select No change to keep the priority setting of the frames.</p> <p>Select Set the packet's 802.1p priority to replace the packet's 802.1p priority field with the value you set in the Priority field.</p>
Outgoing	<p>Select Send the packet to the mirror port to send the packet to the mirror port.</p> <p>Select Send the packet to the egress port to send the packet to the egress port.</p> <p>Select Set the packet's VLAN ID to set the packet's VLAN ID.</p>
Rate Limit	Select Enable to activate bandwidth limitation on the traffic flows then set the actions to be taken on out-of-profile packets.
Add	Click Add to inset the entry to the summary table below and save your changes to the Switch's run-time memory. The Switch loses these changes if it is turned off or loses power, so use the Save link on the top navigation panel to save your changes to the non-volatile memory when you are done configuring.
Cancel	Click Cancel to reset the fields back to your previous configuration.
Clear	Click Clear to set the above fields back to the factory defaults.
Index	This field displays the policy index number. Click an index number to edit the policy.
Active	This field displays Yes when policy is activated and No when is it deactivated.
Name	This field displays the name you have assigned to this policy.
Classifier(s)	This field displays the names of the classifier to which this policy applies.

Table 83 Advanced Application > Policy Rule (continued)

LABEL	DESCRIPTION
	Select an entry's check box to select a specific entry. Otherwise, select the check box in the table heading row to select all entries.
Delete	Click Delete to remove the selected entry from the summary table.
Cancel	Click Cancel to clear the check boxes.

22.3 Policy Example

The figure below shows an example **Policy** screen where you configure a policy to limit bandwidth and discard out-of-profile traffic on a traffic flow classified using the **Example** classifier (refer to [Section 21.5 on page 200](#)).

Figure 149 Policy Example

The screenshot displays the 'Policy' configuration interface. The 'Active' checkbox is checked. The 'Name' field contains 'test'. The 'Classifier(s)' dropdown menu is set to 'Example'. Under the 'Parameters' section, 'VLAN ID' is empty, 'Egress Port' is '1', and 'Priority' is '0'. The 'Rate Limit' section shows 'Bandwidth' set to '1000' kbps. The 'Action' section includes options for 'Forwarding' (No change selected), 'Priority' (No change selected), and 'Outgoing' (Send the packet to the mirror port, egress port, and VLAN ID, all unchecked). The 'Rate Limit' section has an 'Enable' checkbox which is unchecked. At the bottom, there are 'Add', 'Cancel', and 'Clear' buttons, with 'Add' circled in red. A summary table at the bottom shows columns for 'Index', 'Active', 'Name', and 'Classifier(s)', with 'Delete' and 'Cancel' buttons below it.

CHAPTER 23

Queuing Method

23.1 Queuing Method Overview

This chapter introduces the queuing methods supported.

Queuing is used to help solve performance degradation when there is network congestion. Use the **Queuing Method** screen to configure queuing algorithms for outgoing traffic. See also **Priority Queue Assignment** in **Switch Setup** and **802.1p Priority** in **Port Setup** for related information.

23.1.1 What You Can Do

Use the **Queuing Method** screen ([Section 23.2 on page 207](#)) set priorities for the queues of the Switch. This distributes bandwidth across the different traffic queues.

23.1.2 What You Need to Know

Queuing algorithms allow switches to maintain separate queues for packets from each individual source or flow and prevent a source from monopolizing the bandwidth.

Strictly Priority Queuing

Strictly Priority Queuing (SPQ) services queues based on priority only. As traffic comes into the Switch, traffic on the highest priority queue, Q7 is transmitted first. When that queue empties, traffic on the next highest-priority queue, Q6 is transmitted until Q6 empties, and then traffic is transmitted on Q5 and so on. If higher priority queues never empty, then traffic on lower priority queues never gets sent. SPQ does not automatically adapt to changing network requirements.

Weighted Fair Queuing

Weighted Fair Queuing is used to guarantee each queue's minimum bandwidth based on its bandwidth weight (portion) (the number you configure in the Weight field) when there is traffic congestion. WFQ is activated only when a port has more traffic than it can handle. Queues with larger weights get more guaranteed bandwidth than queues with smaller weights. This queuing mechanism is highly efficient in that it divides any available bandwidth across the different traffic queues. By default, the weight for Q0 is 1, for Q1 is 2, for Q2 is 3, and so on.

Weighted Round Robin Scheduling (WRR)

Round Robin Scheduling services queues on a rotating basis and is activated only when a port has more traffic than it can handle. A queue is given an amount of bandwidth irrespective of the incoming traffic on that port. This queue then moves to the back of the list. The next queue is given an equal amount of bandwidth, and then moves to the end of the list; and so on, depending on the number of queues being used. This works in a looping fashion until a queue is empty.

Weighted Round Robin Scheduling (WRR) uses the same algorithm as round robin scheduling, but services queues based on their priority and queue weight (the number you configure in the queue **Weight** field) rather than a fixed amount of bandwidth. WRR is activated only when a port has more traffic than it can handle. Queues with larger weights get more service than queues with smaller weights. This queuing mechanism is highly efficient in that it divides any available bandwidth across the different traffic queues and returns to queues that have not yet emptied.

23.2 Configuring Queuing

Use this screen to set priorities for the queues of the Switch. This distributes bandwidth across the different traffic queues.

Click **Advanced Application > Queuing Method** in the navigation panel.

Figure 150 Advanced Application > Queuing Method

Queuing Method										
Port	Method	Weight								Hybrid-SPQ Lowest-Queue
		Q0	Q1	Q2	Q3	Q4	Q5	Q6	Q7	
*	SPQ ▼	<input type="text"/>	<input type="text"/>	<input type="text"/>	<input type="text"/>	<input type="text"/>	<input type="text"/>	<input type="text"/>	<input type="text"/>	None ▼
1	<input checked="" type="radio"/> SPQ	<input type="text"/>	<input type="text"/>	<input type="text"/>	<input type="text"/>	<input type="text"/>	<input type="text"/>	<input type="text"/>	<input type="text"/>	None ▼
	<input type="radio"/> WFQ	<input type="text"/>	<input type="text"/>	<input type="text"/>	<input type="text"/>	<input type="text"/>	<input type="text"/>	<input type="text"/>	<input type="text"/>	
	<input type="radio"/> WRR	<input type="text"/>	<input type="text"/>	<input type="text"/>	<input type="text"/>	<input type="text"/>	<input type="text"/>	<input type="text"/>	<input type="text"/>	
2	<input checked="" type="radio"/> SPQ	<input type="text"/>	<input type="text"/>	<input type="text"/>	<input type="text"/>	<input type="text"/>	<input type="text"/>	<input type="text"/>	<input type="text"/>	None ▼
	<input type="radio"/> WFQ	<input type="text"/>	<input type="text"/>	<input type="text"/>	<input type="text"/>	<input type="text"/>	<input type="text"/>	<input type="text"/>	<input type="text"/>	
	<input type="radio"/> WRR	<input type="text"/>	<input type="text"/>	<input type="text"/>	<input type="text"/>	<input type="text"/>	<input type="text"/>	<input type="text"/>	<input type="text"/>	
3	<input checked="" type="radio"/> SPQ	<input type="text"/>	<input type="text"/>	<input type="text"/>	<input type="text"/>	<input type="text"/>	<input type="text"/>	<input type="text"/>	<input type="text"/>	None ▼
	<input type="radio"/> WFQ	<input type="text"/>	<input type="text"/>	<input type="text"/>	<input type="text"/>	<input type="text"/>	<input type="text"/>	<input type="text"/>	<input type="text"/>	
	<input type="radio"/> WRR	<input type="text"/>	<input type="text"/>	<input type="text"/>	<input type="text"/>	<input type="text"/>	<input type="text"/>	<input type="text"/>	<input type="text"/>	
4	<input checked="" type="radio"/> SPQ	<input type="text"/>	<input type="text"/>	<input type="text"/>	<input type="text"/>	<input type="text"/>	<input type="text"/>	<input type="text"/>	<input type="text"/>	None ▼
	<input type="radio"/> WFQ	<input type="text"/>	<input type="text"/>	<input type="text"/>	<input type="text"/>	<input type="text"/>	<input type="text"/>	<input type="text"/>	<input type="text"/>	
	<input type="radio"/> WRR	<input type="text"/>	<input type="text"/>	<input type="text"/>	<input type="text"/>	<input type="text"/>	<input type="text"/>	<input type="text"/>	<input type="text"/>	
5	<input checked="" type="radio"/> SPQ	<input type="text"/>	<input type="text"/>	<input type="text"/>	<input type="text"/>	<input type="text"/>	<input type="text"/>	<input type="text"/>	<input type="text"/>	None ▼
	<input type="radio"/> WFQ	<input type="text"/>	<input type="text"/>	<input type="text"/>	<input type="text"/>	<input type="text"/>	<input type="text"/>	<input type="text"/>	<input type="text"/>	
	<input type="radio"/> WRR	<input type="text"/>	<input type="text"/>	<input type="text"/>	<input type="text"/>	<input type="text"/>	<input type="text"/>	<input type="text"/>	<input type="text"/>	
6	<input checked="" type="radio"/> SPQ	<input type="text"/>	<input type="text"/>	<input type="text"/>	<input type="text"/>	<input type="text"/>	<input type="text"/>	<input type="text"/>	<input type="text"/>	None ▼
	<input type="radio"/> WFQ	<input type="text"/>	<input type="text"/>	<input type="text"/>	<input type="text"/>	<input type="text"/>	<input type="text"/>	<input type="text"/>	<input type="text"/>	
	<input type="radio"/> WRR	<input type="text"/>	<input type="text"/>	<input type="text"/>	<input type="text"/>	<input type="text"/>	<input type="text"/>	<input type="text"/>	<input type="text"/>	
7	<input checked="" type="radio"/> SPQ	<input type="text"/>	<input type="text"/>	<input type="text"/>	<input type="text"/>	<input type="text"/>	<input type="text"/>	<input type="text"/>	<input type="text"/>	None ▼
	<input type="radio"/> WFQ	<input type="text"/>	<input type="text"/>	<input type="text"/>	<input type="text"/>	<input type="text"/>	<input type="text"/>	<input type="text"/>	<input type="text"/>	
	<input type="radio"/> WRR	<input type="text"/>	<input type="text"/>	<input type="text"/>	<input type="text"/>	<input type="text"/>	<input type="text"/>	<input type="text"/>	<input type="text"/>	
	<input checked="" type="radio"/> SPQ	<input type="text"/>	<input type="text"/>	<input type="text"/>	<input type="text"/>	<input type="text"/>	<input type="text"/>	<input type="text"/>	<input type="text"/>	None ▼
	<input type="radio"/> WFQ	<input type="text"/>	<input type="text"/>	<input type="text"/>	<input type="text"/>	<input type="text"/>	<input type="text"/>	<input type="text"/>	<input type="text"/>	
	<input type="radio"/> WRR	<input type="text"/>	<input type="text"/>	<input type="text"/>	<input type="text"/>	<input type="text"/>	<input type="text"/>	<input type="text"/>	<input type="text"/>	

The following table describes the labels in this screen.

Table 84 Advanced Application > Queuing Method

LABEL	DESCRIPTION
Port	This label shows the port you are configuring.
*	<p>Settings in this row apply to all ports.</p> <p>Use this row only if you want to make some settings the same for all ports. Use this row first to set the common settings and then make adjustments on a port-by-port basis.</p> <p>Note: Changes in this row are copied to all the ports as soon as you make them.</p>
Method	<p>Select SPQ (Strictly Priority Queuing), WFQ (Weighted Fair Queuing) or WRR (Weighted Round Robin).</p> <p>Strictly Priority Queuing services queues based on priority only. When the highest priority queue empties, traffic on the next highest-priority queue begins. Q7 has the highest priority and Q0 the lowest.</p> <p>Weighted Fair Queuing is used to guarantee each queue's minimum bandwidth based on their bandwidth portion (weight) (the number you configure in the Weight field). Queues with larger weights get more guaranteed bandwidth than queues with smaller weights.</p> <p>Weighted Round Robin Scheduling services queues on a rotating basis based on their queue weight (the number you configure in the queue Weight field). Queues with larger weights get more service than queues with smaller weights.</p>
Weight	When you select WFQ or WRR enter the queue weight here. Bandwidth is divided across the different traffic queues according to their weights.
Hybrid-SPQ Lowest- Queue	<p>This field is applicable only when you select WFQ or WRR.</p> <p>Select a queue (Q0 to Q7) to have the Switch use SPQ to service the subsequent queues after and including the specified queue for the port. For example, if you select Q5, the Switch services traffic on Q5, Q6 and Q7 using SPQ.</p> <p>Select None to always use WFQ or WRR for the port.</p>
Apply	Click Apply to save your changes to the Switch's run-time memory. The Switch loses these changes if it is turned off or loses power, so use the Save link on the top navigation panel to save your changes to the non-volatile memory when you are done configuring.
Cancel	Click Cancel to begin configuring this screen afresh.

CHAPTER 24

Multicast

24.1 Multicast Overview

This chapter shows you how to configure various multicast features.

Traditionally, IP packets are transmitted in one of either two ways – Unicast (one sender to one recipient) or Broadcast (one sender to everybody on the network). Multicast delivers IP packets to just a group of hosts on the network.

IGMP (Internet Group Management Protocol) is a network-layer protocol used to establish membership in a multicast group – it is not used to carry user data. Refer to RFC 1112, RFC 2236 and RFC 3376 for information on IGMP versions 1, 2 and 3 respectively.

24.1.1 What You Can Do

- Use the **Multicast Setup** screen ([Section 24.2 on page 213](#)) to display the links to the configuration screens where you can configure IPv4 multicast settings.
- Use the **IPv4 Multicast Status** screen ([Section 24.3 on page 213](#)) to view multicast group information.
- Use the **IGMP Snooping** screen ([Section 24.3.1 on page 214](#)) to enable IGMP snooping to forward group multicast traffic only to ports that are members of that group.
- Use the **IGMP Snooping VLAN** screen ([Section 24.3.2 on page 217](#)) to perform IGMP snooping on up to 16 VLANs.
- Use the **IGMP Filtering Profile** ([Section 24.3.3 on page 218](#)) to specify a range of multicast groups that clients connected to the Switch are able to join.
- Use the **IPv6 Multicast Status** screen ([Section 24.4 on page 220](#)) to view multicast group information.
- Use the **MLD Snooping-proxy** screen ([Section 24.4.1 on page 220](#)) to enable the upstream port to report group changes to a connected multicast router and forward MLD messages to other upstream ports.
- Use the **MVR** screens ([Section 24.5 on page 226](#)) to create multicast VLANs and select the receiver ports and a source port for each multicast VLAN.

24.1.2 What You Need to Know

Read on for concepts on Multicasting that can help you configure the screens in this chapter.

IP Multicast Addresses

In IPv4, a multicast address allows a device to send packets to a specific group of hosts (multicast group) in a different subnetwork. A multicast IP address represents a traffic receiving group, not individual receiving devices. IP addresses in the Class D range (224.0.0.0 to 239.255.255.255) are used for

IP multicasting. Certain IP multicast numbers are reserved by IANA for special purposes (see the IANA website for more information).

In IPv6, multicast addresses provide the same functionality as IPv4 broadcast addresses. Broadcasting is not supported in IPv6. A multicast address allows a host to send packets to all hosts in a multicast group. Multicast scope allows you to determine the size of the multicast group. A multicast address has a predefined prefix of ff00::/8.

IGMP Filtering

With the IGMP filtering feature, you can control which IGMP groups a subscriber on a port can join. This allows you to control the distribution of multicast services (such as content information distribution) based on service plans and types of subscription.

You can set the Switch to filter the multicast group join reports on a per-port basis by configuring an IGMP filtering profile and associating the profile to a port.

IGMP Snooping

A Switch can passively snoop on IGMP packets transferred between IP multicast routers or switches and IP multicast hosts to learn the IP multicast group membership. It checks IGMP packets passing through it, picks out the group registration information, and configures multicasting accordingly. IGMP snooping allows the Switch to learn multicast groups without you having to manually configure them.

The Switch forwards multicast traffic destined for multicast groups (that it has learned from IGMP snooping or that you have manually configured) to ports that are members of that group. IGMP snooping generates no additional network traffic, allowing you to significantly reduce multicast traffic passing through your Switch.

IGMP Snooping and VLANs

The Switch can perform IGMP snooping on up to 16 VLANs. You can configure the Switch to automatically learn multicast group membership of any VLANs. The Switch then performs IGMP snooping on the first 16 VLANs that send IGMP packets. This is referred to as auto mode. Alternatively, you can specify the VLANs that IGMP snooping should be performed on. This is referred to as fixed mode. In fixed mode the Switch does not learn multicast group membership of any VLANs other than those explicitly added as an IGMP snooping VLAN.

MLD Snooping-proxy

MLD snooping-proxy is a Zyxel-proprietary feature. IPv6 MLD proxy allows only one upstream interface on a switch, while MLD snooping-proxy supports more than one upstream port on a switch. The upstream port in MLD snooping-proxy can report group changes to a connected multicast router and forward MLD messages to other upstream ports. This helps especially when you want to have a network that uses STP to provide backup links between switches and also performs MLD snooping and proxy functions. MLD snooping-proxy, like MLD proxy, can minimize MLD control messages and allow better network performance.

In MLD snooping-proxy, if one upstream port is learned via snooping, all other upstream ports on the same device will be added to the same group. If one upstream port requests to leave a group, all other upstream ports on the same device will also be removed from the group.

In the following MLD snooping-proxy example, all connected upstream ports (1 – 7) are treated as one

interface. The connection between ports 8 and 9 is blocked by STP to break the loop. If there is one query from a router (X) or MLD Done or Report message from any upstream port, it will be broadcast to all connected upstream ports.

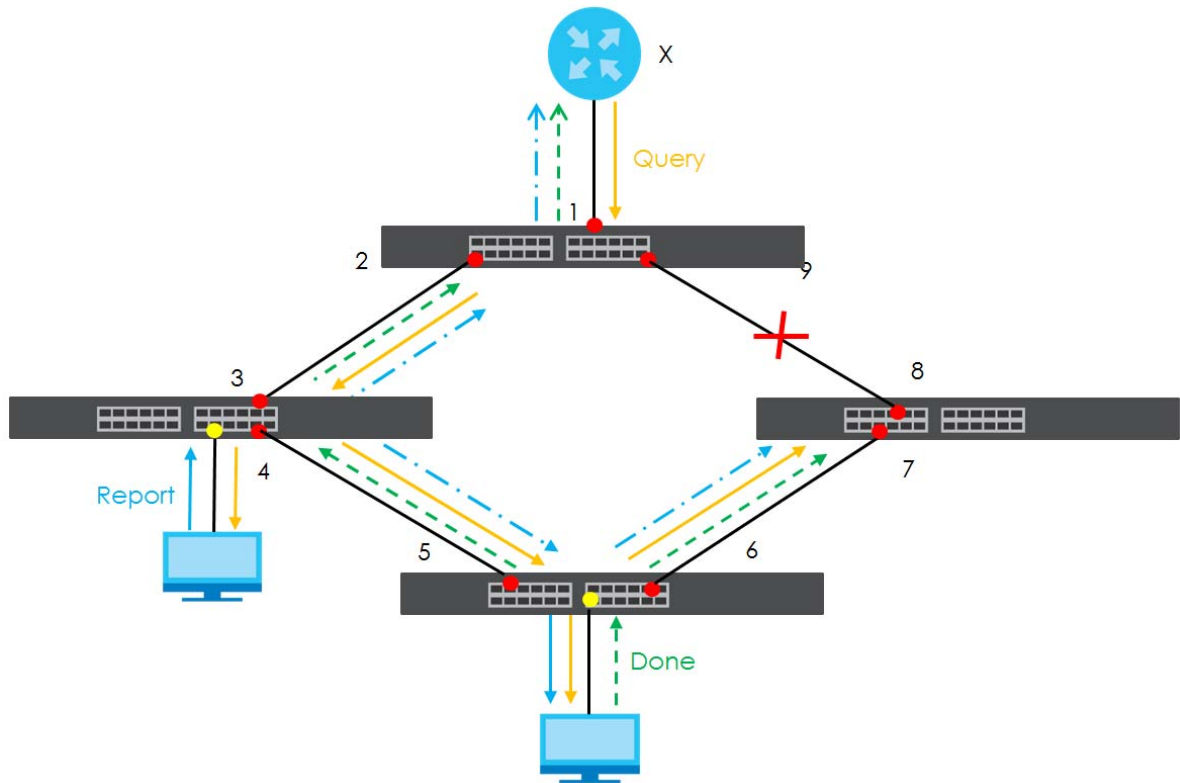

MLD Messages

A multicast router or switch periodically sends general queries to MLD hosts to update the multicast forwarding table. When an MLD host wants to join a multicast group, it sends an MLD Report message for that address.

An MLD Done message is similar to an IGMP Leave message. When an MLD host wants to leave a multicast group, it can send a Done message to the router or switch. If the leave mode is not set to **Immediate**, the router or switch sends a group-specific query to the port on which the Done message is received to determine if other devices connected to this port should remain in the group.

MVR Overview

Multicast VLAN Registration (MVR) is designed for applications (such as Media-on-Demand (MoD)) that use multicast traffic across an Ethernet ring-based service provider network.

MVR allows one single multicast VLAN to be shared among different subscriber VLANs on the network. While isolated in different subscriber VLANs, connected devices can subscribe to and unsubscribe from the multicast stream in the multicast VLAN. This improves bandwidth utilization with reduced multicast traffic in the subscriber VLANs and simplifies multicast group management.

MVR only responds to IGMP join and leave control messages from multicast groups that are configured under MVR. Join and leave reports from other multicast groups are managed by IGMP snooping.

The following figure shows a network example. The subscriber VLAN (1, 2 and 3) information is hidden from the streaming media server, **S**. In addition, the multicast VLAN information is only visible to the Switch and **S**.

Figure 151 MVR Network Example



Types of MVR Ports

In MVR, a source port is a port on the Switch that can send and receive multicast traffic in a multicast VLAN while a receiver port can only receive multicast traffic. Once configured, the Switch maintains a forwarding table that matches the multicast stream to the associated multicast group.

MVR Modes

You can set your Switch to operate in either dynamic or compatible mode.

In dynamic mode, the Switch sends IGMP leave and join reports to the other multicast devices (such as multicast routers or servers) in the multicast VLAN. This allows the multicast devices to update the multicast forwarding table to forward or not forward multicast traffic to the receiver ports.

In compatible mode, the Switch does not send any IGMP reports. In this case, you must manually configure the forwarding settings on the multicast devices in the multicast VLAN.

How MVR Works

The following figure shows a multicast television example where a subscriber device (such as a computer) in VLAN 1 receives multicast traffic from the streaming media server, **S**, via the Switch. Multiple subscriber devices can connect through a port configured as the receiver on the Switch.

When the subscriber selects a television channel, computer **A** sends an IGMP report to the Switch to join the appropriate multicast group. If the IGMP report matches one of the configured MVR multicast group addresses on the Switch, an entry is created in the forwarding table on the Switch. This maps the subscriber VLAN to the list of forwarding destinations for the specified multicast traffic.

When the subscriber changes the channel or turns off the computer, an IGMP leave message is sent to the Switch to leave the multicast group. The Switch sends a query to VLAN 1 on the receiver port (in this case, an uplink port on the Switch). If there is another subscriber device connected to this port in the same subscriber VLAN, the receiving port will still be on the list of forwarding destination for the multicast traffic. Otherwise, the Switch removes the receiver port from the forwarding table.

Figure 152 MVR Multicast Television Example



24.2 Multicast Setup

Use this screen to configure IGMP for IPv4. Click **Advanced Application** > **Multicast** in the navigation panel.

Figure 153 Advanced Application > Multicast Setup

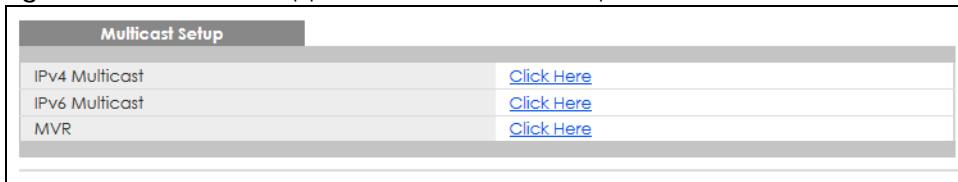

The following table describes the labels in this screen.

Table 85 Advanced Application > Multicast Setup

LABEL	DESCRIPTION
IPv4 Multicast	Click the link to open screens where you can configure IGMP snooping and IGMP filtering for IPv4.
IPv6 Multicast	Click the link to open screens where you can configure MLD snooping-proxy and MLD filtering for IPv6.
MVR	Click the link to open screens where you can create multicast VLANs.

24.3 IPv4 Multicast Status

Click **Advanced Application** > **Multicast** > **IPv4 Multicast** to display the screen as shown. This screen shows the IPv4 multicast group information. See [Section 24.1 on page 209](#) for more information on multicasting.

Figure 154 Advanced Application > Multicast > IPv4 Multicast

Index	VID	Port	Multicast Group
-------	-----	------	-----------------

The following table describes the labels in this screen.

Table 86 Advanced Application > Multicast > IPv4 Multicast

LABEL	DESCRIPTION
Index	This is the index number of the entry.
VID	This field displays the multicast VLAN ID.
Port	This field displays the port number that belongs to the multicast group.
Multicast Group	This field displays IP multicast group addresses.

24.3.1 IGMP Snooping

Click the **IGMP Snooping** link in the **Advanced Application > Multicast > IPv4 Multicast** screen to display the screen as shown. See [Section 24.1 on page 209](#) for more information on multicasting.

Figure 155 Advanced Application > Multicast > IPv4 Multicast > IGMP Snooping

IGMP Snooping [IPv4 Multicast Status](#) [IGMP Snooping VLAN](#) [IGMP Filtering Profile](#)

IGMP Snooping: Active Querier Report Proxy Host Timeout: 260 802.1p Priority: No-Change

IGMP Filtering: Active

Unknown Multicast Frame: Flooding Drop Drop on VLAN Forwarding on VLAN

Unknown Multicast Frame to Querier Port: Drop Forwarding Forwarding on VLAN

Reserved Multicast Group: Flooding Drop

Port	Immed. Leave	Normal Leave	Fast Leave	Group Limited	Max Group Num.	Throttling	IGMP Filtering Profile	IGMP Querier Mode
*	<input type="radio"/>	<input checked="" type="radio"/>		<input type="checkbox"/>		Deny	Default	Auto
1	<input type="radio"/>	<input checked="" type="radio"/>	4000	<input type="checkbox"/>	0	Deny	Default	Auto
2	<input type="radio"/>	<input checked="" type="radio"/>	4000	<input type="checkbox"/>	0	Deny	Default	Auto
3	<input type="radio"/>	<input checked="" type="radio"/>	4000	<input type="checkbox"/>	0	Deny	Default	Auto
4	<input type="radio"/>	<input checked="" type="radio"/>	4000	<input type="checkbox"/>	0	Deny	Default	Auto
5	<input type="radio"/>	<input checked="" type="radio"/>	4000	<input type="checkbox"/>	0	Deny	Default	Auto
6	<input type="radio"/>	<input checked="" type="radio"/>	4000	<input type="checkbox"/>	0	Deny	Default	Auto
7	<input type="radio"/>	<input checked="" type="radio"/>	4000	<input type="checkbox"/>	0	Deny	Default	Auto
8	<input type="radio"/>	<input checked="" type="radio"/>	4000	<input type="checkbox"/>	0	Deny	Default	Auto
9	<input type="radio"/>	<input checked="" type="radio"/>	4000	<input type="checkbox"/>	0	Deny	Default	Auto
10	<input type="radio"/>	<input checked="" type="radio"/>	4000	<input type="checkbox"/>	0	Deny	Default	Auto
11	<input type="radio"/>	<input checked="" type="radio"/>	4000	<input type="checkbox"/>	0	Deny	Default	Auto
48	<input type="radio"/>	<input checked="" type="radio"/>	4000	<input type="checkbox"/>	0	Deny	Default	Auto
49	<input type="radio"/>	<input checked="" type="radio"/>	4000	<input type="checkbox"/>	0	Deny	Default	Auto
50	<input type="radio"/>	<input checked="" type="radio"/>	4000	<input type="checkbox"/>	0	Deny	Default	Auto

Apply Cancel

The following table describes the labels in this screen.

Table 87 Advanced Application > Multicast > IPv4 Multicast > IGMP Snooping

LABEL	DESCRIPTION
IGMP Snooping	Use these settings to configure IGMP snooping.
Active	Select Active to enable IGMP Snooping to forward group multicast traffic only to ports that are members of that group.
Querier	Select this option to allow the Switch to send IGMP General Query messages to the VLANs with the multicast hosts attached.
Report Proxy	Select this option to allow the Switch to act as the IGMP report proxy and leave proxy. It will report group changes to a connected multicast router. The Switch not only checks IGMP packets between multicast routers or switches and multicast hosts to learn the multicast group membership, but also replaces the source MAC address in an IGMP v1/v2 report with its own MAC address before forwarding to the multicast router or switch. When the Switch receives more than one IGMP v1/v2 join report that requests to join the same multicast group, it only sends a new join report with its MAC address. This helps reduce the number of multicast join reports passed to the multicast router or switch. The Switch sends a leave message with its MAC address to the multicast router or switch only when it receives the leave message from the last host in a multicast group.
Host Timeout	Specify the time (from 1 to 16711450) in seconds that elapses before the Switch removes an IGMP group membership entry if it does not receive report messages from the port.
802.1p Priority	Select a priority level (0 – 7) to which the Switch changes the priority in outgoing IGMP control packets. Otherwise, select No-Change to not replace the priority.
IGMP Filtering	Select Active to enable IGMP filtering to control which IGMP groups a subscriber on a port can join. If you enable IGMP filtering, you must create and assign IGMP filtering profiles for the ports that you want to allow to join multicast groups.
Unknown Multicast Frame	Specify the action to perform when the Switch receives an unknown multicast frame. <ul style="list-style-type: none"> Select Drop to discard the frames. Select Flooding to send the frames to all ports. Select Drop on VLAN and enter the VLAN ID numbers to discard the frames on the specified VLANs. Use a dash to specify consecutive VLANs and a comma (no spaces) to specify non-consecutive VLANs. For example, 51–53 includes 51, 52 and 53, but 51,53 does not include 52.
Unknown Multicast Frame to Querier Port	Specify the action to perform when Unknown Multicast Frame is set to Drop . <ul style="list-style-type: none"> Select Drop to discard the frames. Select Forwarding to send the frames to all querier ports. Select Forwarding on VLAN and enter the VLAN ID numbers to send the frames to the ports which are used as an IGMP query port on the specified VLANs. Use a dash to specify consecutive VLANs and a comma (no spaces) to specify non-consecutive VLANs. For example, 51–53 includes 51, 52 and 53, but 51,53 does not include 52.
Reserved Multicast Group	The IP address range of 224.0.0.0 to 224.0.0.255 are reserved for multicasting on the local network only. For example, 224.0.0.1 is for all hosts on a local network segment and 224.0.0.9 is used to send RIP routing information to all RIP v2 routers on the same network segment. A multicast router will not forward a packet with the destination IP address within this range to other networks. See the IANA web site for more information. The layer-2 multicast MAC addresses used by Cisco layer-2 protocols, 01:00:0C:CC:CC:CC and 01:00:0C:CC:CC:CD, are also included in this group. Specify the action to perform when the Switch receives a frame with a reserved multicast address. <ul style="list-style-type: none"> Select Drop to discard the frames. Select Flooding to send the frames to all ports.
Port	This field displays the port number.

Table 87 Advanced Application > Multicast > IPv4 Multicast > IGMP Snooping (continued)

LABEL	DESCRIPTION
*	<p>Settings in this row apply to all ports.</p> <p>Use this row only if you want to make some settings the same for all ports. Use this row first to set the common settings and then make adjustments on a port-by-port basis.</p> <p>Changes in this row are copied to all the ports as soon as you make them.</p>
Immed. Leave	<p>Select this option to set the Switch to remove this port from the multicast tree when an IGMP version 2 leave message is received on this port.</p> <p>Select this option if there is only one host connected to this port.</p>
Normal Leave	<p>Enter an IGMP normal leave timeout value (from 200 to 6348800) in milliseconds. Select this option to have the Switch use this timeout to update the forwarding table for the port.</p> <p>In normal leave mode, when the Switch receives an IGMP leave message from a host on a port, it forwards the message to the multicast router. The multicast router then sends out an IGMP Group-Specific Query (GSQ) message to determine whether other hosts connected to the port should remain in the specific multicast group. The Switch forwards the query message to all hosts connected to the port and waits for IGMP reports from hosts to update the forwarding table.</p> <p>This defines how many seconds the Switch waits for an IGMP report before removing an IGMP snooping membership entry when an IGMP leave message is received on this port from a host.</p>
Fast Leave	<p>Enter an IGMP fast leave timeout value (from 200 to 6348800) in milliseconds. Select this option to have the Switch use this timeout to update the forwarding table for the port.</p> <p>In fast leave mode, right after receiving an IGMP leave message from a host on a port, the Switch itself sends out an IGMP Group-Specific Query (GSQ) message to determine whether other hosts connected to the port should remain in the specific multicast group. This helps speed up the leave process.</p> <p>This defines how many seconds the Switch waits for an IGMP report before removing an IGMP snooping membership entry when an IGMP leave message is received on this port from a host.</p>
Group Limited	<p>Select this option to limit the number of multicast groups this port is allowed to join.</p>
Max Group Num.	<p>Enter the number of multicast groups this port is allowed to join. Once a port is registered in the specified number of multicast groups, any new IGMP join report frames is dropped on this port.</p>
Throttling	<p>IGMP throttling controls how the Switch deals with the IGMP reports when the maximum number of the IGMP groups a port can join is reached.</p> <p>Select Deny to drop any new IGMP join report received on this port until an existing multicast forwarding table entry is aged out.</p> <p>Select Replace to replace an existing entry in the multicast forwarding table with the new IGMP reports received on this port.</p>
IGMP Filtering Profile	<p>Select the name of the IGMP filtering profile to use for this port. Otherwise, select Default to prohibit the port from joining any multicast group.</p> <p>You can create IGMP filtering profiles in the Multicast > IPv4 Multicast > IGMP Snooping > IGMP Filtering Profile screen.</p>

Table 87 Advanced Application > Multicast > IPv4 Multicast > IGMP Snooping (continued)

LABEL	DESCRIPTION
IGMP Querier Mode	<p>The Switch treats an IGMP query port as being connected to an IGMP multicast router (or server). The Switch forwards IGMP join or leave packets to an IGMP query port.</p> <p>Select Auto to have the Switch use the port as an IGMP query port if the port receives IGMP query packets.</p> <p>Select Fixed to have the Switch always use the port as an IGMP query port. Select this when you connect an IGMP multicast server to the port.</p> <p>Select Edge to stop the Switch from using the port as an IGMP query port. The Switch will not keep any record of an IGMP router being connected to this port. The Switch does not forward IGMP join or leave packets to this port.</p>
Apply	Click Apply to save your changes to the Switch's run-time memory. The Switch loses these changes if it is turned off or loses power, so use the Save link on the top navigation panel to save your changes to the non-volatile memory when you are done configuring.
Cancel	Click Cancel to begin configuring this screen afresh.

24.3.2 IGMP Snooping VLAN

Click **Advanced Application > Multicast > IPv4 Multicast** in the navigation panel. Click the **IGMP Snooping** link and then the **IGMP Snooping VLAN** link to display the screen as shown. See [IGMP Snooping and VLANs on page 210](#) for more information on IGMP Snooping VLAN.

Figure 156 Advanced Application > Multicast > IPv4 Multicast > IGMP Snooping > IGMP Snooping VLAN

The screenshot shows the configuration interface for IGMP Snooping VLAN. At the top, there is a breadcrumb trail: **IGMP Snooping VLAN** and a link to **IGMP Snooping**. The **Mode** section contains two radio buttons: **auto** (which is selected) and **fixed**. Below this are **Apply** and **Cancel** buttons. The **VLAN** section has two input fields: **Name** and **VID**. Below these fields are **Add**, **Cancel**, and **Clear** buttons. At the bottom of the page, there is a table with three columns: **Index**, **Name**, and **VID**. Below the table are **Delete** and **Cancel** buttons.

The following table describes the labels in this screen.

Table 88 Advanced Application > Multicast > IPv4 Multicast > IGMP Snooping > IGMP Snooping VLAN

LABEL	DESCRIPTION
Mode	<p>Select auto to have the Switch learn multicast group membership information of any VLANs automatically.</p> <p>Select fixed to have the Switch only learn multicast group membership information of the VLANs that you specify below.</p> <p>In either auto or fixed mode, the Switch can learn up to 16 VLANs (including up to five VLANs you configured in the MVR screen). For example, if you have configured one multicast VLAN in the MVR screen, you can only specify up to 15 VLANs in this screen.</p> <p>The Switch drops any IGMP control messages which do not belong to these 16 VLANs.</p> <p>You must also enable IGMP snooping in the Multicast > IPv4 Multicast > IGMP Snooping screen first.</p>
Apply	Click Apply to save your changes to the Switch's run-time memory. The Switch loses these changes if it is turned off or loses power, so use the Save link on the top navigation panel to save your changes to the non-volatile memory when you are done configuring.
Cancel	Click Cancel to begin configuring this screen afresh.
VLAN	Use this section of the screen to add VLANs upon which the Switch is to perform IGMP snooping.
Name	Enter the descriptive name of the VLAN for identification purposes.
VID	<p>Enter the ID of a static VLAN; the valid range is between 1 and 4094.</p> <p>Note: You cannot configure the same VLAN ID as in the MVR screen.</p>
Add	<p>Click this to create a new entry or to update an existing one.</p> <p>This saves your changes to the Switch's run-time memory. The Switch loses these changes if it is turned off or loses power, so use the Save link on the top navigation panel to save your changes to the non-volatile memory when you are done configuring.</p>
Cancel	Click Cancel to reset the fields to your previous configuration.
Clear	Click Clear to reset the fields to the factory defaults.
Index	This is the index number of the IGMP snooping VLAN entry in the table. Click on an index number to view more details or change the settings.
Name	This field displays the descriptive name for this VLAN group.
VID	This field displays the ID number of the VLAN group.
	Select an entry's check box to select a specific entry. Otherwise, select the check box in the table heading row to select all entries.
Delete	Check the entries that you want to remove, then click the Delete button.
Cancel	Click Cancel to clear the check boxes.

24.3.3 IGMP Filtering Profile

An IGMP filtering profile specifies a range of multicast groups that clients connected to the Switch are able to join. A profile contains a range of multicast IP addresses which you want clients to be able to join. Profiles are assigned to ports (in the **IGMP Snooping** screen). Clients connected to those ports are then able to join the multicast groups specified in the profile. Each port can be assigned a single profile. A profile can be assigned to multiple ports.

Click **Advanced Application > Multicast > IPv4 Multicast** in the navigation panel. Click the **IGMP Snooping** link and then the **IGMP Filtering Profile** link to display the screen as shown.

Figure 157 Advanced Application > Multicast > IPv4 Multicast > IGMP Snooping > IGMP Filtering Profile

The screenshot shows the 'IGMP Filtering Profile' configuration interface. At the top, there is a breadcrumb trail: 'Advanced Application > Multicast > IPv4 Multicast > IGMP Snooping > IGMP Filtering Profile'. The main heading is 'IGMP Filtering Profile' with a 'IGMP Snooping' link on the right. Below the heading is a 'Profile Setup' section. This section contains a table with three columns: 'Profile Name', 'Start Address', and 'End Address'. The 'Start Address' field is populated with '224.0.0.0' and the 'End Address' field is populated with '224.0.0.0'. Below this table are 'Add' and 'Clear' buttons. Below the 'Add' and 'Clear' buttons is another table with five columns: 'Profile Name', 'Start Address', 'End Address', 'Delete Profile', and 'Delete Rule'. The 'Profile Name' column contains 'Default'. The 'Start Address' and 'End Address' columns contain '0.0.0.0'. The 'Delete Profile' and 'Delete Rule' columns each contain a checkbox. Below this table are 'Delete' and 'Cancel' buttons.

The following table describes the labels in this screen.

Table 89 Advanced Application > Multicast > IPv4 Multicast > IGMP Snooping > IGMP Filtering Profile

LABEL	DESCRIPTION
Profile Name	Enter a descriptive name for the profile for identification purposes. To configure additional rules for a profile that you have already added, enter the profile name and specify a different IP multicast address range.
Start Address	Type the starting multicast IP address for a range of multicast IP addresses that you want to belong to the IGMP filter profile.
End Address	Type the ending multicast IP address for a range of IP addresses that you want to belong to the IGMP filter profile. If you want to add a single multicast IP address, enter it in both the Start Address and End Address fields.
Add	Click this to create a new entry. This saves your changes to the Switch's run-time memory. The Switch loses these changes if it is turned off or loses power, so use the Save link on the top navigation panel to save your changes to the non-volatile memory when you are done configuring.
Clear	Click Clear to reset the fields to the factory defaults.
Profile Name	This field displays the descriptive name of the profile.
Start Address	This field displays the start of the multicast address range.
End Address	This field displays the end of the multicast address range.
Delete Profile	Select a profile's check box to select a specific profile. Otherwise, select the check box in the table heading row to select all profiles.
Delete Rule	Select the check boxes of the rules that you want to remove from a profile.
Delete	To delete the profiles and all the accompanying rules, select the profiles that you want to remove in the Delete Profile column, then click the Delete button. To delete a rules from a profile, select the rules that you want to remove in the Delete Rule column, then click the Delete button.
Cancel	Click Cancel to clear the Delete Profile or Delete Rule check boxes.

24.4 IPv6 Multicast Status

Click **Advanced Application > Multicast > IPv6 Multicast** to display the screen as shown. This screen shows the IPv6 multicast group information. See [Section 24.1 on page 209](#) for more information on multicasting.

Figure 158 Advanced Application > Multicast > IPv6 Multicast

Index	VID	Port	Multicast Group	Group Timeout

The following table describes the fields in the above screen.

Table 90 Advanced Application > Multicast > IPv6 Multicast

LABEL	DESCRIPTION
Index	This is the index number of the entry.
VID	This field displays the multicast VLAN ID.
Port	This field displays the port number that belongs to the multicast group.
Multicast Group	This field displays IP multicast group addresses.
Group Timeout	This field displays the time (in seconds) that elapses before the Switch removes a MLD group membership entry if it does not receive report messages from the port.

24.4.1 MLD Snooping-proxy

Click the **MLD Snooping-proxy** link in the **Advanced Application > Multicast > IPv6 Multicast** screen to display the screen as shown. See [Section 24.1 on page 209](#) for more information on multicasting.

Figure 159 Advanced Application > Multicast > IPv6Multicast > MLD Snooping-proxy

MLD Snooping-proxy	Active	<input type="checkbox"/>
	802.1p Priority	0 ▾
<input type="button" value="Apply"/> <input type="button" value="Cancel"/>		

The following table describes the fields in the above screen.

Table 91 Advanced Application > Multicast > IPv6 Multicast > MLD Snooping-proxy

LABEL	DESCRIPTION
MLD Snooping-proxy	Use these settings to configure MLD snooping-proxy.
Active	Select Active to enable MLD snooping-proxy on the Switch to minimize MLD control messages and allow better network performance.
802.1p Priority	Select a priority level (0 – 7) to which the Switch changes the priority in outgoing MLD messages.
Apply	Click Apply to save your changes to the Switch's run-time memory. The Switch loses these changes if it is turned off or loses power, so use the Save link on the top navigation panel to save your changes to the non-volatile memory when you are done configuring.
Cancel	Click Cancel to begin configuring this screen afresh.

24.4.2 MLD Snooping-proxy VLAN

Click the **VLAN** link in the **Advanced Application > Multicast > IPv6 Multicast > MLD Snooping-proxy** screen to display the screen as shown. See [Section 24.1 on page 209](#) for more information on multicasting.

Figure 160 Advanced Application > Multicast > IPv6 Multicast > MLD Snooping-proxy > VLAN

VLAN		MLD Snooping-proxy Port Role Setting	
VID	<input type="text"/>		
Upstream	Query Interval	125000	milliseconds
	Maximum Response Delay	10000	milliseconds
	Robustness Variable	2	
	Last Member Query Interval	1000	milliseconds
Downstream	Query Interval	125000	milliseconds
	Maximum Response Delay	10000	milliseconds
<input type="button" value="Add"/> <input type="button" value="Cancel"/> <input type="button" value="Clear"/>			
Index		VID	
<input type="button" value="Delete"/> <input type="button" value="Cancel"/>			

The following table describes the fields in the above screen.

Table 92 Advanced Application > Multicast > IPv6 Multicast > MLD Snooping-proxy > VLAN

LABEL	DESCRIPTION
VID	Enter the ID number of the VLAN on which you want to enable MLD snooping-proxy and configure related settings.
Upstream	
Query Interval	<p>Enter the amount of time (in milliseconds) between general query messages sent by the router connected to the upstream port. This value should be exactly the same as what is configured in the connected multicast router.</p> <p>This value is used to calculate the amount of time an MLD snooping membership entry (learned only on the upstream port) can remain in the forwarding table.</p> <p>When an MLD Report message is received, the Switch sets the timeout period of the entry to be $T = (QI \cdot RV) + MRD$, where T = Timeout, QI = Query Interval, RV = Robustness Variable, and MRD = Maximum Response Delay.</p>
Maximum Response Delay	<p>Enter the amount of time (in milliseconds) the router connected to the upstream port waits for a response to an MLD general query message. This value should be exactly the same as what is configured in the connected multicast router.</p> <p>This value is used to calculate the amount of time an MLD snooping membership entry (learned only on the upstream port) can remain in the forwarding table.</p> <p>When an MLD Report message is received, the Switch sets the timeout period of the entry to be $T = (QI \cdot RV) + MRD$, where T = Timeout, QI = Query Interval, RV = Robustness Variable, and MRD = Maximum Response Delay.</p> <p>When an MLD Done message is received, the Switch sets the entry's lifetime to be the product of Last Member Query Interval and Robustness Variable.</p>

Table 92 Advanced Application > Multicast > IPv6 Multicast > MLD Snooping-proxy > VLAN (continued)

LABEL	DESCRIPTION
Robustness Variable	<p>Enter the number of queries. A multicast address entry (learned only on an upstream port by snooping) is removed from the forwarding table when there is no response to the configured number of queries sent by the router connected to the upstream port. This value should be exactly the same as what's configured in the connected multicast router.</p> <p>This value is used to calculate the amount of time an MLD snooping membership entry (learned only on the upstream port) can remain in the forwarding table.</p>
Last Member Query Interval	<p>Enter the amount of time (in milliseconds) between the MLD group-specific queries sent by an upstream port when an MLD Done message is received. This value should be exactly the same as what's configured in the connected multicast router.</p> <p>This value is used to calculate the amount of time an MLD snooping membership entry (learned only on the upstream port) can remain in the forwarding table after a Done message is received.</p> <p>When an MLD Done message is received, the Switch sets the entry's lifetime to be the product of Last Member Query Interval and Robustness Variable.</p>
Downstream	
Query Interval	Enter the amount of time (in milliseconds) between general query messages sent by the downstream port.
Maximum Response Delay	Enter the maximum time (in milliseconds) that the Switch waits for a response to a general query message sent by the downstream port.
Add	<p>Click this to create a new entry or to update an existing one.</p> <p>This saves your changes to the Switch's run-time memory. The Switch loses these changes if it is turned off or loses power, so use the Save link on the top navigation panel to save your changes to the non-volatile memory when you are done configuring.</p>
Cancel	Click Cancel to reset the fields to your previous configuration.
Clear	Click Clear to reset the fields to the factory defaults.
Index	This is the index number of the MLD snooping-proxy VLAN entry in the table. Click on an index number to view more details or change the settings.
VID	This field displays the ID number of the VLAN group.
	Select an entry's check box to select a specific entry. Otherwise, select the check box in the table heading row to select all entries.
Delete	Click Delete to remove the selected entries permanently.
Cancel	Click Cancel to clear the check boxes.

24.4.3 MLD Snooping-proxy VLAN Port Role Setting

Click the **Port Role Setting** link in the **Advanced Application > Multicast > IPv6 Multicast > MLD Snooping-proxy > VLAN** screen to display the screen as shown. See [Section 24.1 on page 209](#) for more information on multicasting.

Figure 161 Advanced Application > Multicast > IPv6 Multicast > MLD Snooping-proxy > VLAN > Port Role Setting

Port	Port Role	Leave Mode	Leave Timeout	Fast Leave Timeout
*	None	Normal		
1	None	Normal	4000	4000
2	None	Normal	4000	4000
3	None	Normal	4000	4000
4	None	Normal	4000	4000
5	None	Normal	4000	4000
6	None	Normal	4000	4000
7	None	Normal	4000	4000
8	None	Normal	4000	4000
9	None	Normal	4000	4000
10	None	Normal	4000	4000

The following table describes the fields in the above screen.

Table 93 Advanced Application > Multicast > IPv6 Multicast > MLD Snooping-proxy > VLAN > Port Role Setting

LABEL	DESCRIPTION
MLD Snooping-proxy VLAN ID	Select the VLAN ID for which you want to configure a port's MLD snooping-proxy settings.
Port	This field displays the port number.
*	Settings in this row apply to all ports. Use this row only if you want to make some settings the same for all ports. Use this row first to set the common settings and then make adjustments on a port-by-port basis. Changes in this row are copied to all the ports as soon as you make them.
Port Role	A port on the Switch can be either a Downstream port or Upstream port in MLD. A downstream port connects to MLD hosts and acts as a multicast router to send MLD queries and listen to the MLD host's Report and Done messages. An upstream port connects to a multicast router and works as a host to send Report or Done messages when receiving queries from a multicast router. Otherwise, select None if the port is not joining a multicast group or does not belong to this VLAN.
Leave Mode	Select the leave mode for the specified downstream ports in this VLAN. This specifies whether the Switch removes an MLD snooping membership entry (learned on a downstream port) immediately (Immediate) or wait for an MLD report before the leave timeout (Normal) or fast leave timeout (Fast) when an MLD leave message is received on this port from a host.

Table 93 Advanced Application > Multicast > IPv6 Multicast > MLD Snooping-proxy > VLAN > Port Role Setting (continued)

LABEL	DESCRIPTION
Leave Timeout	Enter the MLD snooping normal leave timeout (in milliseconds) the Switch uses to update the forwarding table for the specified downstream ports. This defines how many seconds the Switch waits for an MLD report before removing an MLD snooping membership entry (learned on a downstream port) when an MLD Done message is received on this port from a host.
Fast Leave Timeout	Enter the fast leave timeout (in milliseconds) for the specified downstream ports. This defines how many seconds the Switch waits for an MLD report before removing an MLD snooping membership entry (learned on a downstream port) when an MLD Done message is received on this port from a host.
Apply	Click Apply to save your changes to the Switch's run-time memory. The Switch loses these changes if it is turned off or loses power, so use the Save link on the top navigation panel to save your changes to the non-volatile memory when you are done configuring.
Cancel	Click Cancel to reset the fields to your previous configuration.

24.4.4 MLD Snooping-proxy Filtering

Use this screen to configure the Switch's MLD filtering settings. Click the **Filtering** link in the **Advanced Application > Multicast > IPv6 Multicast > MLD Snooping-proxy** screen to display the screen as shown.

Figure 162 Advanced Application > Multicast > IPv6 Multicast > MLD Snooping-proxy > Filtering

Port	Group Limit	Max Group Num.	Filtering Profile
*	<input type="checkbox"/>		Default
1	<input type="checkbox"/>	0	Default
2	<input type="checkbox"/>	0	Default
3	<input type="checkbox"/>	0	Default
4	<input type="checkbox"/>	0	Default
5	<input type="checkbox"/>	0	Default
6	<input type="checkbox"/>	0	Default
7	<input type="checkbox"/>	0	Default
8	<input type="checkbox"/>	0	Default
9	<input type="checkbox"/>	0	Default

The following table describes the fields in the above screen.

Table 94 Advanced Application > Multicast > IPv6 Multicast > MLD Snooping-proxy > Filtering

LABEL	DESCRIPTION
Active	Select this option to enable MLD filtering on the Switch.
Port	This field displays the port number.

Table 94 Advanced Application > Multicast > IPv6 Multicast > MLD Snooping-proxy > Filtering

LABEL	DESCRIPTION
*	Settings in this row apply to all ports. Use this row only if you want to make some settings the same for all ports. Use this row first to set the common settings and then make adjustments on a port-by-port basis. Changes in this row are copied to all the ports as soon as you make them.
Group Limit	Select this option to limit the number of multicast groups this port is allowed to join.
Max Group Num.	Enter the number of multicast groups this port is allowed to join. Once a port is registered in the specified number of multicast groups, any new MLD Report message is dropped on this port.
Filtering Profile	Select the name of the MLD filtering profile to use for this port. Otherwise, select Default to prohibit the port from joining any multicast group. You can create MLD filtering profiles in the Multicast > IPv6 Multicast > MLD Snooping-proxy > Filtering > Filtering Profile screen.
Apply	Click Apply to save your changes to the Switch's run-time memory. The Switch loses these changes if it is turned off or loses power, so use the Save link on the top navigation panel to save your changes to the non-volatile memory when you are done configuring.
Cancel	Click Cancel to reset the fields to your previous configuration.

24.4.5 MLD Snooping-proxy Filtering Profile

Use this screen to create an MLD filtering profile and set the range of the multicast addresses. Click the **Filtering Profile** link in the **Advanced Application > Multicast > IPv6 Multicast > MLD Snooping-proxy > Filtering** screen to display the screen as shown.

Figure 163 Advanced Application > Multicast > IPv6 Multicast > MLD Snooping-proxy > Filtering > Filtering Profile

The screenshot shows the 'Filtering Profile' configuration interface. At the top, there is a header 'Filtering Profile' and a 'Filtering' link. Below this is a 'Profile Setup' section with three input fields: 'Profile Name', 'Start Address', and 'End Address'. Underneath these fields are 'Add' and 'Clear' buttons. A table below lists existing profiles with columns for 'Profile Name', 'Start Address', 'End Address', and a checkbox. The 'Default' profile is shown with 'Start Address' 0:0:0:0:0:0:0:0 and 'End Address' 0:0:0:0:0:0:0:0. At the bottom of the screen are 'Delete' and 'Cancel' buttons.

The following table describes the fields in the above screen.

Table 95 Advanced Application > Multicast > IPv6 Multicast > MLD Snooping-proxy > Filtering > Filtering Profile

LABEL	DESCRIPTION
Profile Name	Enter a descriptive name for the profile for identification purposes. To configure additional rules for a profile that you have already added, enter the profile name and specify a different IP multicast address range.
Start Address	Type the starting multicast IPv6 address for a range of multicast IPv6 addresses that you want to belong to the MLD filtering profile.
End Address	Type the ending multicast IPv6 address for a range of IPv6 addresses that you want to belong to the MLD filtering profile. If you want to add a single multicast IPv6 address, enter it in both the Start Address and End Address fields.
Add	Click this to create a new entry. This saves your changes to the Switch's run-time memory. The Switch loses these changes if it is turned off or loses power, so use the Save link on the top navigation panel to save your changes to the non-volatile memory when you are done configuring.
Clear	Click Clear to reset the fields to the factory defaults.
Profile Name	This field displays the descriptive name of the profile.
Start Address	This field displays the start of the multicast IPv6 address range.
End Address	This field displays the end of the multicast IPv6 address range.
	To delete the profiles and all the accompanying rules, select the profiles that you want to remove, then click the Delete button. You can select the check box in the table heading row to select all profiles. To delete a rules from a profile, select the rules that you want to remove, then click the Delete button.
Delete	Click Delete button to permanently delete the entries you selected.
Cancel	Click Cancel to clear the check boxes.

24.5 General MVR Configuration

Use the **MVR** screen to create multicast VLANs and select the receiver ports and a source port for each multicast VLAN. Click **Advanced Application > Multicast > MVR** to display the screen as shown next.

Note: You can create up to five multicast VLANs and up to 256 multicast rules on the Switch.

Note: Your Switch automatically creates a static VLAN (with the same VID) when you create a multicast VLAN in this screen.

Figure 164 Advanced Application > Multicast > MVR

The following table describes the related labels in this screen.

Table 96 Advanced Application > Multicast > MVR

LABEL	DESCRIPTION
Active	Select this check box to enable MVR to allow one single multicast VLAN to be shared among different subscriber VLANs on the network.
Group Name	Enter a descriptive name (up to 32 printable ASCII characters) for identification purposes.
Multicast VLAN ID	Enter the VLAN ID (1 to 4094) of the multicast VLAN.
802.1p Priority	Select a priority level (0 – 7) with which the Switch replaces the priority in outgoing IGMP or MLD control packets (belonging to this multicast VLAN).
Mode	Specify the MVR mode on the Switch. Choices are Dynamic and Compatible . Select Dynamic to send IGMP reports or MLD messages to all MVR source ports in the multicast VLAN. Select Compatible to set the Switch not to send IGMP reports or MLD messages.
Port	This field displays the port number on the Switch.
*	Settings in this row apply to all ports. Use this row only if you want to make some settings the same for all ports. Use this row first to set the common settings and then make adjustments on a port-by-port basis. Changes in this row are copied to all the ports as soon as you make them.

Table 96 Advanced Application > Multicast > MVR (continued)

LABEL	DESCRIPTION
Source Port	Select this option to set this port as the MVR source port that sends and receives multicast traffic. All source ports must belong to a single multicast VLAN.
Receiver Port	Select this option to set this port as a receiver port that only receives multicast traffic.
None	Select this option to set the port not to participate in MVR. No MVR multicast traffic is sent or received on this port.
Tagging	Select this check box if you want the port to tag the VLAN ID in all outgoing frames transmitted.
Add	Click this to create a new entry or to update an existing one. This saves your changes to the Switch's run-time memory. The Switch loses these changes if it is turned off or loses power, so use the Save link on the top navigation panel to save your changes to the non-volatile memory when you are done configuring.
Cancel	Click Cancel to begin configuring this screen afresh.
VLAN	This field displays the multicast VLAN ID. Click on an index number to change the settings.
Active	This field displays whether the multicast group is enabled or not.
Name	This field displays the descriptive name for this setting.
Mode	This field displays the MVR mode.
Source Port	This field displays the source port numbers.
Receiver Port	This field displays the receiver port numbers.
802.1p	This field displays the priority level.
	Select an entry's check box to select a specific entry. Otherwise, select the check box in the table heading row to select all entries.
Delete	To delete a multicast VLANs, select the rules that you want to remove, then click the Delete button.
Cancel	Click Cancel to clear the check boxes.

24.5.1 MVR Group Configuration

All source ports and receiver ports belonging to a multicast group can receive multicast data sent to this multicast group.

Use this screen to configure MVR IP multicast group addresses. Click the **Group Configuration** link in the **MVR** screen.

Note: A port can belong to more than one multicast VLAN. However, IP multicast group addresses in different multicast VLANs cannot overlap.

Figure 165 Advanced Application > Multicast > MVR > Group Configuration

The following table describes the labels in this screen.

Table 97 Advanced Application > Multicast > MVR > Group Configuration

LABEL	DESCRIPTION
Multicast VLAN ID	Select a multicast VLAN ID (that you configured in the MVR screen) from the drop-down list box.
Group Name	Enter a descriptive name for identification purposes.
Start Address	Enter the starting IP multicast address of the multicast group in dotted decimal notation.
End Address	Enter the ending IP multicast address of the multicast group in dotted decimal notation. Enter the same IP address as the Start Address field if you want to configure only one IP address for a multicast group.
Add	Click this to create a new entry. This saves your changes to the Switch's run-time memory. The Switch loses these changes if it is turned off or loses power, so use the Save link on the top navigation panel to save your changes to the non-volatile memory when you are done configuring.
Cancel	Click Cancel to begin configuring this screen afresh.
MVLAN	This field displays the multicast VLAN ID.
Group Name	This field displays the descriptive name for this setting.
Start Address	This field displays the starting IP address of the multicast group.
End Address	This field displays the ending IP address of the multicast group.
	To delete the profiles and all the accompanying rules, select the profiles that you want to remove, then click the Delete button. You can select the check box in the table heading row to select all profiles. To delete rules from a profile, select the rules that you want to remove, then click the Delete button.
Delete	Select the entries that you want to remove, then click the Delete button to remove the selected entries from the table. If you delete a multicast VLAN, all multicast groups in this VLAN will also be removed.
Cancel	Select Cancel to clear the check boxes in the table.

24.5.2 MVR Configuration Example

The following figure shows a network example where ports 1, 2 and 3 on the Switch belong to VLAN 1. In addition, port 7 belongs to the multicast group with VID 200 to receive multicast traffic (the **News** and **Movie** channels) from the remote streaming media server, **S**. Computers A, B and C in VLAN 1 are able to receive the traffic.

Figure 166 MVR Configuration Example

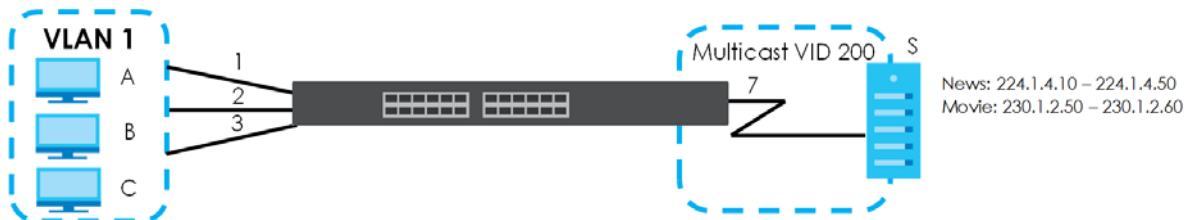

To configure the MVR settings on the Switch, create a multicast VLAN in the **MVR** screen and set the receiver and source ports.

Figure 167 MVR Configuration Example

The screenshot shows the 'MVR' configuration page. At the top right, there are links for 'Multicast Setup' and 'Group Configuration'. The main configuration area includes the following fields:

- Active:
- Group Name: Premium
- Multicast VLAN ID: 200
- 802.1p Priority: 0
- Mode: Dynamic Compatible

Below these fields is a table for configuring ports:

Port	Source Port	Receiver Port	None	Tagging
*		Receiver	▼	<input type="checkbox"/>
1	<input type="radio"/>	<input checked="" type="radio"/>	<input type="radio"/>	<input type="checkbox"/>
2	<input type="radio"/>	<input checked="" type="radio"/>	<input type="radio"/>	<input type="checkbox"/>
3	<input type="radio"/>	<input checked="" type="radio"/>	<input type="radio"/>	<input type="checkbox"/>
4	<input type="radio"/>	<input type="radio"/>	<input checked="" type="radio"/>	<input type="checkbox"/>
5	<input type="radio"/>	<input type="radio"/>	<input checked="" type="radio"/>	<input type="checkbox"/>
6	<input type="radio"/>	<input type="radio"/>	<input checked="" type="radio"/>	<input type="checkbox"/>
7	<input checked="" type="radio"/>	<input type="radio"/>	<input type="radio"/>	<input checked="" type="checkbox"/>
8	<input type="radio"/>	<input checked="" type="radio"/>	<input type="radio"/>	<input type="checkbox"/>
9	<input type="radio"/>	<input checked="" type="radio"/>	<input type="radio"/>	<input type="checkbox"/>

At the bottom of the page, there are 'Add' and 'Cancel' buttons, and a red 'EXAMPLE' stamp.

To set the Switch to forward the multicast group traffic to the subscribers, configure multicast group settings in the **Group Configuration** screen. The following figure shows an example where two IPv4 multicast groups (**News** and **Movie**) are configured for the multicast VLAN 200.

Figure 168 MVR Group Configuration Example-1

Group Configuration MVR

Multicast VLAN ID: 200

Group Name	Movie	
Start Address	230.1.2.50	
End Address	230.1.2.60	

Add Cancel

EXAMPLE

MVLAN

Group Name	Start Address	End Address	
200			<input type="checkbox"/>
News	224.1.4.10	224.1.4.50	<input type="checkbox"/>

Delete Cancel

Figure 169 MVR Group Configuration Example-2

Group Configuration MVR

Multicast VLAN ID: 200

Group Name:

Start Address:

End Address:

Add Cancel

EXAMPLE

MVLAN

Group Name	Start Address	End Address	
200			<input type="checkbox"/>
Movie	230.1.2.50	230.1.2.60	<input type="checkbox"/>
News	224.1.4.10	224.1.4.50	<input type="checkbox"/>

Delete Cancel

CHAPTER 25

AAA

25.1 Authentication, Authorization and Accounting (AAA)

This chapter describes how to configure authentication, authorization and accounting settings on the Switch.

The external servers that perform authentication, authorization and accounting functions are known as AAA servers. The Switch supports RADIUS (Remote Authentication Dial-In User Service) as the external authentication, authorization, and accounting server.

Figure 170 AAA Server



25.1.1 What You Can Do

- Use the **AAA** screen ([Section 25.2 on page 233](#)) to display the links to the screens where you can enable authentication and authorization or both of them on the Switch.
- use the **RADIUS Server Setup** screen ([Section 25.3 on page 233](#)) to configure your RADIUS server settings.
- Use the **TACACS+ Server Setup** screen ([Section 25.4 on page 235](#)) to configure your TACACS+ authentication settings.
- Use the **AAA Setup** screen ([Section 25.5 on page 237](#)) to configure authentication, authorization and accounting settings, such as the methods used to authenticate users accessing the Switch and which database the Switch should use first.

25.1.2 What You Need to Know

Authentication is the process of determining who a user is and validating access to the Switch. The Switch can authenticate users who try to log in based on user accounts configured on the Switch itself. The Switch can also use an external authentication server to authenticate a large number of users.

Authorization is the process of determining what a user is allowed to do. Different user accounts may have higher or lower privilege levels associated with them. For example, user A may have the right to create new login accounts on the Switch but user B cannot. The Switch can authorize users based on user accounts configured on the Switch itself or it can use an external server to authorize a large number of users.

Accounting is the process of recording what a user is doing. The Switch can use an external server to track when users log in, log out, execute commands and so on. Accounting can also record system

related actions such as boot up and shut down times of the Switch.

Local User Accounts

By storing user profiles locally on the Switch, your Switch is able to authenticate and authorize users without interacting with a network AAA server. However, there is a limit on the number of users you may authenticate in this way.

RADIUS and TACACS+

RADIUS and TACACS+ are security protocols used to authenticate users by means of an external server instead of (or in addition to) an internal device user database that is limited to the memory capacity of the device. In essence, RADIUS and TACACS+ authentication both allow you to validate an unlimited number of users from a central location.

The following table describes some key differences between RADIUS and TACACS+.

Table 98 RADIUS vs. TACACS+

	RADIUS	TACACS+
Transport Protocol	UDP (User Datagram Protocol)	TCP (Transmission Control Protocol)
Encryption	Encrypts the password sent for authentication.	All communication between the client (the Switch) and the TACACS server is encrypted.

25.2 AAA Screens

The **AAA** screens allow you to enable authentication and authorization or both of them on the Switch. First, configure your authentication server settings (RADIUS, TACACS+ or both) and then set up the authentication priority, activate authorization.

Click **Advanced Application > AAA** in the navigation panel to display the screen as shown.

Figure 171 Advanced Application > AAA



25.3 RADIUS Server Setup

Use this screen to configure your RADIUS server settings. Click the **RADIUS Server Setup** link in the **AAA** screen to view the screen as shown.

Figure 172 Advanced Application > AAA > RADIUS Server Setup

RADIUS Server Setup
[AAA](#)

Authentication Server

Mode	index-priority ▾	
Timeout	30	seconds

Index	IP Address	UDP Port	Shared Secret	Delete
1	0.0.0.0 <input type="text"/>	1812	<input type="text"/>	<input type="checkbox"/>
2	0.0.0.0 <input type="text"/>	1812	<input type="text"/>	<input type="checkbox"/>

Accounting Server

Timeout	30	seconds
---------	----	---------

Index	IP Address	UDP Port	Shared Secret	Delete
1	0.0.0.0 <input type="text"/>	1813	<input type="text"/>	<input type="checkbox"/>
2	0.0.0.0 <input type="text"/>	1813	<input type="text"/>	<input type="checkbox"/>

Attribute

NAS-IP-Address	0.0.0.0 <input type="text"/>
----------------	------------------------------

The following table describes the labels in this screen.

Table 99 Advanced Application > AAA > RADIUS Server Setup

LABEL	DESCRIPTION
Authentication Server	Use this section to configure your RADIUS authentication settings.
Mode	<p>This field is only valid if you configure multiple RADIUS servers.</p> <p>Select index-priority and the Switch tries to authenticate with the first configured RADIUS server, if the RADIUS server does not respond then the Switch tries to authenticate with the second RADIUS server.</p> <p>Select round-robin to alternate between the RADIUS servers that it sends authentication requests to.</p>
Timeout	<p>Specify the amount of time in seconds that the Switch waits for an authentication request response from the RADIUS server.</p> <p>If you are using index-priority for your authentication and you are using two RADIUS servers then the timeout value is divided between the two RADIUS servers. For example, if you set the timeout value to 30 seconds, then the Switch waits for a response from the first RADIUS server for 15 seconds and then tries the second RADIUS server.</p>
Index	This is a read-only number representing a RADIUS server entry.
IP Address	Enter the IP address of an external RADIUS server in dotted decimal notation.
UDP Port	The default port of a RADIUS server for authentication is 1812 . You need not change this value unless your network administrator instructs you to do so.

Table 99 Advanced Application > AAA > RADIUS Server Setup (continued)

LABEL	DESCRIPTION
Shared Secret	Specify a password (up to 32 alphanumeric characters) as the key to be shared between the external RADIUS server and the Switch. This key is not sent over the network. This key must be the same on the external RADIUS server and the Switch.
Delete	Check this box if you want to remove an existing RADIUS server entry from the Switch. This entry is deleted when you click Apply .
Accounting Server	Use this section to configure your RADIUS accounting server settings.
Timeout	Specify the amount of time in seconds that the Switch waits for an accounting request response from the RADIUS accounting server.
Index	This is a read-only number representing a RADIUS accounting server entry.
IP Address	Enter the IP address of an external RADIUS accounting server in dotted decimal notation.
UDP Port	The default port of a RADIUS accounting server for accounting is 1813 . You need not change this value unless your network administrator instructs you to do so.
Shared Secret	Specify a password (up to 32 alphanumeric characters) as the key to be shared between the external RADIUS accounting server and the Switch. This key is not sent over the network. This key must be the same on the external RADIUS accounting server and the Switch.
Delete	Check this box if you want to remove an existing RADIUS accounting server entry from the Switch. This entry is deleted when you click Apply .
Attribute	Use this section to define the RADIUS server attribute for its account.
NAS-IP-Address	Enter the IP address of the NAS (Network Access Server).
Apply	Click Apply to save your changes to the Switch's run-time memory. The Switch loses these changes if it is turned off or loses power, so use the Save link on the top navigation panel to save your changes to the non-volatile memory when you are done configuring.
Cancel	Click Cancel to begin configuring this screen afresh.

25.4 TACACS+ Server Setup

Use this screen to configure your TACACS+ server settings. Click on the **TACACS+ Server Setup** link in the **AAA** screen to view the screen as shown.

Figure 173 Advanced Application > AAA > TACACS+ Server Setup

TACACS+ Server Setup
AAA

Authentication Server

Mode	index-priority ▼	
Timeout	30	seconds

Index	IP Address	TCP Port	Shared Secret	Delete
1	0.0.0.0	49		<input type="checkbox"/>
2	0.0.0.0	49		<input type="checkbox"/>

Accounting Server

Timeout	30	seconds
---------	----	---------

Index	IP Address	TCP Port	Shared Secret	Delete
1	0.0.0.0	49		<input type="checkbox"/>
2	0.0.0.0	49		<input type="checkbox"/>

Apply
Cancel

The following table describes the labels in this screen.

Table 100 Advanced Application > AAA > TACACS+ Server Setup

LABEL	DESCRIPTION
Authentication Server	Use this section to configure your TACACS+ authentication settings.
Mode	<p>This field is only valid if you configure multiple TACACS+ servers.</p> <p>Select index-priority and the Switch tries to authenticate with the first configured TACACS+ server, if the TACACS+ server does not respond then the Switch tries to authenticate with the second TACACS+ server.</p> <p>Select round-robin to alternate between the TACACS+ servers that it sends authentication requests to.</p>
Timeout	<p>Specify the amount of time in seconds that the Switch waits for an authentication request response from the TACACS+ server.</p> <p>If you are using index-priority for your authentication and you are using two TACACS+ servers then the timeout value is divided between the two TACACS+ servers. For example, if you set the timeout value to 30 seconds, then the Switch waits for a response from the first TACACS+ server for 15 seconds and then tries the second TACACS+ server.</p>
Index	This is a read-only number representing a TACACS+ server entry.
IP Address	Enter the IP address of an external TACACS+ server in dotted decimal notation.
TCP Port	The default port of a TACACS+ server for authentication is 49 . You need not change this value unless your network administrator instructs you to do so.
Shared Secret	Specify a password (up to 32 alphanumeric characters) as the key to be shared between the external TACACS+ server and the Switch. This key is not sent over the network. This key must be the same on the external TACACS+ server and the Switch.

Table 100 Advanced Application > AAA > TACACS+ Server Setup (continued)

LABEL	DESCRIPTION
Delete	Check this box if you want to remove an existing TACACS+ server entry from the Switch. This entry is deleted when you click Apply .
Accounting Server	Use this section to configure your TACACS+ accounting settings.
Timeout	Specify the amount of time in seconds that the Switch waits for an accounting request response from the TACACS+ server.
Index	This is a read-only number representing a TACACS+ accounting server entry.
IP Address	Enter the IP address of an external TACACS+ accounting server in dotted decimal notation.
TCP Port	The default port of a TACACS+ accounting server is 49 . You need not change this value unless your network administrator instructs you to do so.
Shared Secret	Specify a password (up to 32 alphanumeric characters) as the key to be shared between the external TACACS+ accounting server and the Switch. This key is not sent over the network. This key must be the same on the external TACACS+ accounting server and the Switch.
Delete	Check this box if you want to remove an existing TACACS+ accounting server entry from the Switch. This entry is deleted when you click Apply .
Apply	Click Apply to save your changes to the Switch's run-time memory. The Switch loses these changes if it is turned off or loses power, so use the Save link on the top navigation panel to save your changes to the non-volatile memory when you are done configuring.
Cancel	Click Cancel to begin configuring this screen afresh.

25.5 AAA Setup

Use this screen to configure authentication, authorization and accounting settings on the Switch. Click on the **AAA Setup** link in the **AAA** screen to view the screen as shown.

Figure 174 Advanced Application > AAA > AAA Setup

AAA Setup [AAA](#)

Authentication

Type	Method 1	Method 2	Method 3
Login	local	-	-

Authorization

Type	Active	Method
Exec	<input type="checkbox"/>	radius
Dot1x	<input type="checkbox"/>	radius

Accounting

Update Period: 0 minutes

Type	Active	Broadcast	Mode	Method
System	<input type="checkbox"/>	<input type="checkbox"/>	-	radius
Dot1x	<input type="checkbox"/>	<input type="checkbox"/>	start-stop	radius

[Apply](#) [Cancel](#)

The following table describes the labels in this screen.

Table 101 Advanced Application > AAA > AAA Setup

LABEL	DESCRIPTION
Authentication	Use this section to specify the methods used to authenticate users accessing the Switch.
Login	<p>These fields specify which database the Switch should use (first, second and third) to authenticate administrator accounts (users for Switch management).</p> <p>Configure the local user accounts in the Access Control > Logins screen. The TACACS+ and RADIUS are external servers. Before you specify the priority, make sure you have set up the corresponding database correctly first.</p> <p>You can specify up to three methods for the Switch to authenticate administrator accounts. The Switch checks the methods in the order you configure them (first Method 1, then Method 2 and finally Method 3). You must configure the settings in the Method 1 field. If you want the Switch to check other sources for administrator accounts, specify them in Method 2 and Method 3 fields.</p> <p>Select local to have the Switch check the administrator accounts configured in the Access Control > Logins screen.</p> <p>Select radius to have the Switch check the administrator accounts configured via the RADIUS Server.</p> <p>Select tacacs+ to have the Switch check the administrator accounts configured via the TACACS+ Server.</p>
Authorization	Use this section to configure authorization settings on the Switch.
Type	<p>Set whether the Switch provides the following services to a user.</p> <ul style="list-style-type: none"> • Exec: Allow an administrator which logs into the Switch through Telnet or SSH to have a different access privilege level assigned via the external server. • Dot1x: Allow an IEEE 802.1x client to have different bandwidth limit or VLAN ID assigned via the external server.
Active	Select this to activate authorization for a specified event types.
Method	<p>Select whether you want to use RADIUS or TACACS+ for authorization of specific types of events.</p> <p>RADIUS is the only method for IEEE 802.1x authorization.</p>
Accounting	Use this section to configure accounting settings on the Switch.
Update Period	This is the amount of time in minutes before the Switch sends an update to the accounting server. This is only valid if you select the start-stop option for the Exec or Dot1x entries.
Type	<p>The Switch supports the following types of events to be sent to the accounting servers:</p> <ul style="list-style-type: none"> • System – Configure the Switch to send information when the following system events occur: system boots up, system shuts down, system accounting is enabled, system accounting is disabled. • Exec – Configure the Switch to send information when an administrator logs in and logs out via the console port, telnet or SSH. • Dot1x – Configure the Switch to send information when an IEEE 802.1x client begins a session (authenticates via the Switch), ends a session as well as interim updates of a session. • Commands – Configure the Switch to send information when commands of specified privilege level and higher are executed on the Switch.
Active	Select this to activate accounting for a specified event types.
Broadcast	<p>Select this to have the Switch send accounting information to all configured accounting servers at the same time.</p> <p>If you do not select this and you have two accounting servers set up, then the Switch sends information to the first accounting server and if it does not get a response from the accounting server then it tries the second accounting server.</p>

Table 101 Advanced Application > AAA > AAA Setup (continued)

LABEL	DESCRIPTION
Mode	<p>The Switch supports two modes of recording login events. Select:</p> <ul style="list-style-type: none"> • start-stop – to have the Switch send information to the accounting server when a user begins a session, during a user's session (if it lasts past the Update Period), and when a user ends a session. • stop-only – to have the Switch send information to the accounting server only when a user ends a session.
Method	<p>Select whether you want to use RADIUS or TACACS+ for accounting of specific types of events. TACACS+ is the only method for recording Commands type of event.</p>
Apply	<p>Click Apply to save your changes to the Switch's run-time memory. The Switch loses these changes if it is turned off or loses power, so use the Save link on the top navigation panel to save your changes to the non-volatile memory when you are done configuring.</p>
Cancel	<p>Click Cancel to begin configuring this screen afresh.</p>

25.6 Technical Reference

This section provides technical background information on the topics discussed in this chapter.

25.6.1 Vendor Specific Attribute

RFC 2865 standard specifies a method for sending vendor-specific information between a RADIUS server and a network access device (for example, the Switch). A company can create Vendor Specific Attributes (VSAs) to expand the functionality of a RADIUS server.

The Switch supports VSAs that allow you to perform the following actions based on user authentication:

- Limit bandwidth on incoming or outgoing traffic for the port the user connects to.
- Assign account privilege levels (See the CLI Reference Guide for more information on account privilege levels) for the authenticated user.

The VSAs are composed of the following:

- **Vendor-ID:** An identification number assigned to the company by the IANA (Internet Assigned Numbers Authority). Zyxel's vendor ID is 890.
- **Vendor-Type:** A vendor specified attribute, identifying the setting you want to modify.
- **Vendor-data:** A value you want to assign to the setting.

Note: Refer to the documentation that comes with your RADIUS server on how to configure VSAs for users authenticating via the RADIUS server.

The following table describes the VSAs supported on the Switch.

Table 102 Supported VSAs

FUNCTION	ATTRIBUTE
Ingress Bandwidth Assignment	Vendor-Id = 890 Vendor-Type = 1 Vendor-data = ingress rate (Kbps in decimal format)
Egress Bandwidth Assignment	Vendor-Id = 890 Vendor-Type = 2 Vendor-data = egress rate (Kbps in decimal format)
Privilege Assignment	Vendor-ID = 890 Vendor-Type = 3 Vendor-Data = " shell:priv-lvl=N " or Vendor-ID = 9 (CISCO) Vendor-Type = 1 (CISCO-AVPAIR) Vendor-Data = " shell:priv-lvl=N " where N is a privilege level (from 0 to 14). Note: If you set the privilege level of a login account differently on the RADIUS servers and the Switch, the user is assigned a privilege level from the database (RADIUS or local) the Switch uses first for user authentication.

25.6.1.1 Tunnel Protocol Attribute

You can configure tunnel protocol attributes on the RADIUS server (refer to your RADIUS server documentation) to assign a port on the Switch to a VLAN. The port VLAN settings are fixed and untagged. This will also set the port's VID. The following table describes the values you need to configure. Note that the bolded values in the table are fixed values as defined in RFC 3580.

Table 103 Supported Tunnel Protocol Attribute

FUNCTION	ATTRIBUTE
VLAN Assignment	Tunnel-Type = VLAN (13) Tunnel-Medium-Type = 802 (6) Tunnel-Private-Group-ID = VLAN ID Note: You must also create a VLAN with the specified VID on the Switch. Note: The bolded values in this table are fixed values as defined in RFC 3580.

25.6.2 Supported RADIUS Attributes

Remote Authentication Dial-In User Service (RADIUS) attributes are data used to define specific authentication elements in a user profile, which is stored on the RADIUS server. This section lists the RADIUS attributes supported by the Switch.

Refer to RFC 2865 for more information about RADIUS attributes used for authentication.

This section lists the attributes used by authentication functions on the Switch. In cases where the

attribute has a specific format associated with it, the format is specified.

25.6.3 Attributes Used for Authentication

The following sections list the attributes sent from the Switch to the RADIUS server when performing authentication.

25.6.3.1 Attributes Used for Authenticating Privilege Access

User-Name

- The format of the User-Name attribute is **\$enab#\$**, where # is the privilege level (1 – 14).

User-Password

NAS-Identifier

NAS-IP-Address

25.6.3.2 Attributes Used to Login Users

User-Name

User-Password

NAS-Identifier

NAS-IP-Address

25.6.3.3 Attributes Used by the IEEE 802.1x Authentication

User-Name

NAS-Identifier

NAS-IP-Address

NAS-Port

NAS-Port-Type

- This value is set to **Ethernet(15)** on the Switch.

Calling-Station-Id

Frame-MTU

EAP-Message

State

Message-Authenticator

CHAPTER 26

IP Source Guard

26.1 IP Source Guard Overview

IP source guard uses a binding table to distinguish between authorized and unauthorized DHCP and ARP packets in your network. A binding contains these key attributes:

- MAC address
- VLAN ID
- IP address
- Port number

When the Switch receives a DHCP or ARP packet, it looks up the appropriate MAC address, VLAN ID, IP address, and port number in the binding table. If there is a binding, the Switch forwards the packet. If there is not a binding, the Switch discards the packet.

26.1.1 What You Can Do

- Use the **IP Source Guard** screen ([Section 26.2 on page 243](#)) to look at the current bindings for DHCP snooping and ARP inspection.
- Use the **IP Source Guard Static Binding** screen ([Section 26.3 on page 243](#)) to manage static bindings for DHCP snooping and ARP inspection.

26.1.2 What You Need to Know

The Switch builds the binding table by snooping DHCP packets (dynamic bindings) and from information provided manually by administrators (static bindings).

IP source guard consists of the following features:

- Static bindings. Use this to create static bindings in the binding table.
- DHCP snooping. Use this to filter unauthorized DHCP packets on the network and to build the binding table dynamically.
- ARP inspection. Use this to filter unauthorized ARP packets on the network.

If you want to use dynamic bindings to filter unauthorized ARP packets (typical implementation), you have to enable DHCP snooping before you enable ARP inspection.

Use this screen to look at the current bindings for DHCP snooping and ARP inspection. Bindings are used by DHCP snooping and ARP inspection to distinguish between authorized and unauthorized packets in the network. The Switch learns the bindings by snooping DHCP packets (dynamic bindings) and from information provided manually by administrators (static bindings). To open this screen, click **Advanced**

Application > IP Source Guard.

Figure 175 Advanced Application > IP Source Guard

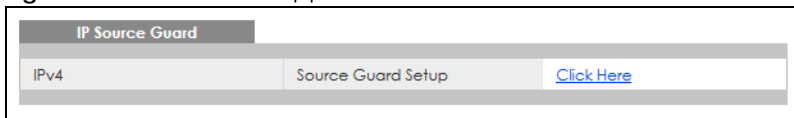

The following table describes the labels in this screen.

Table 104 Advanced Application > IP Source Guard

LABEL	DESCRIPTION
IPv4 Source Guard Setup	Click the link to open screens where you can view and manage static bindings, configure DHCP snooping or ARP inspection and look at various statistics.

26.2 IPv4 Source Guard Setup

Use this screen to look at the current bindings for DHCP snooping and ARP inspection. Bindings are used by DHCP snooping and ARP inspection to distinguish between authorized and unauthorized packets in the network. The Switch learns the bindings by snooping DHCP packets (dynamic bindings) and from information provided manually by administrators (static bindings). To open this screen, click **Advanced Application > IP Source Guard > IPv4 Source Guard Setup**.

Figure 176 Advanced Application > IP Source Guard > IPv4 Source Guard Setup

The following table describes the labels in this screen.

Table 105 Advanced Application > IP Source Guard > IPv4 Source Guard Setup

LABEL	DESCRIPTION
Index	This field displays a sequential number for each binding.
IP Address	This field displays the IP address assigned to the MAC address in the binding.
VLAN	This field displays the source VLAN ID in the binding.
MAC Address	This field displays the source MAC address in the binding.
Port	This field displays the port number in the binding. If this field is blank, the binding applies to all ports.
Lease	This field displays how many days, hours, minutes, and seconds the binding is valid; for example, 2d3h4m5s means the binding is still valid for 2 days, 3 hours, 4 minutes, and 5 seconds. This field displays infinity if the binding is always valid (for example, a static binding).
Type	This field displays how the Switch learned the binding. static : This binding was learned from information provided manually by an administrator. dhcp-snooping : This binding was learned by snooping DHCP packets.

26.3 IPv4 Source Guard Static Binding

Use this screen to manage static bindings for DHCP snooping and ARP inspection. Static bindings are

uniquely identified by the MAC address and VLAN ID. Each MAC address and VLAN ID can only be in one static binding. If you try to create a static binding with the same MAC address and VLAN ID as an existing static binding, the new static binding replaces the original one. To open this screen, click **Advanced Application > IP Source Guard > IPv4 Source Guard Setup > Static Binding**.

Figure 177 Advanced Application > IP Source Guard > IPv4 Source Guard Setup > Static Binding

The following table describes the labels in this screen.

Table 106 Advanced Application > IP Source Guard > IPv4 Source Guard Setup > Static Binding

LABEL	DESCRIPTION
ARP Freeze	ARP Freeze allows you to automatically create static bindings from the current ARP entries (either dynamically learned or static ARP entries) until the Switch's binding table is full. Note: The ARP learning mode should be set to ARP-Request in the IP Application > ARP Setup > ARP Learning screen before you use the ARP Freeze feature.
Condition	All – Select this and click ARP Freeze to have the Switch automatically add all the current ARP entries to the static bindings table. Port List – Select this and enter the number of the ports (separated by a comma). ARP entries learned on the specified ports are added to the static bindings table after you click ARP Freeze . VLAN List – Select this and enter the ID number of the VLANs (separated by a comma). ARP entries for the specified VLANs are added to the static bindings table after you click ARP Freeze .
Static Binding	
IP Address	Enter the IP address assigned to the MAC address in the binding.
VLAN	Enter the source VLAN ID in the binding.
MAC Address	Enter the source MAC address in the binding. If this binding applies to all MAC addresses, select Any .
Port	Specify the ports in the binding. If this binding has one port, select the first radio button and enter the port number in the field to the right. If this binding applies to all ports, select Any .

Table 106 Advanced Application > IP Source Guard > IPv4 Source Guard Setup > Static Binding

LABEL	DESCRIPTION
Add	Click this to create a new entry or to update an existing one. This saves your changes to the Switch's run-time memory. The Switch loses these changes if it is turned off or loses power, so use the Save link on the top navigation panel to save your changes to the non-volatile memory when you are done configuring.
Cancel	Click this to reset the values above based on the last selected static binding or, if not applicable, to clear the fields above.
Clear	Click Clear to reset the fields to the factory defaults.
Index	This field displays a sequential number for each binding. Click on an index number to view more details or change the settings.
IP Address	This field displays the IP address assigned to the MAC address in the binding.
VLAN	This field displays the source VLAN ID in the binding.
MAC Address	This field displays the source MAC address in the binding.
Port	This field displays the port number.
Lease	This field displays how long the binding is valid.
Type	This field displays how the Switch learned the binding. static: This binding was learned from information provided manually by an administrator.
	Select an entry's check box to select a specific entry. Otherwise, select the check box in the table heading row to select all entries.
Delete	Select the entries that you want to remove, then click the Delete button to remove the selected entries from the table.
Cancel	Click this to clear the check boxes above.

CHAPTER 27

DHCP Snooping

27.1 DHCP Snooping Overview

With DHCP snooping, the Switch can build the binding table dynamically by snooping DHCP packets (dynamic bindings) and filter unauthorized DHCP packets in your network.

The Switch uses a binding table to distinguish between authorized and unauthorized DHCP packets in your network. A binding contains these key attributes:

- MAC address
- VLAN ID
- IP address
- Port number

When the Switch receives a DHCP packet, it looks up the appropriate MAC address, VLAN ID, IP address, and port number in the binding table. If there is a binding, the Switch forwards the packet. If there is not a binding, the Switch discards the packet.

27.1.1 What You Can Do

- Use the **DHCP Snooping** screen ([Section 27.2 on page 246](#)) to look at various statistics about the DHCP snooping database.
- Use this **DHCP Snooping Configure** screen ([Section 27.3 on page 249](#)) to enable DHCP snooping on the Switch (not on specific VLAN), specify the VLAN where the default DHCP server is located, and configure the DHCP snooping database.
- Use the **DHCP Snooping Port Configure** screen ([Section 27.3.1 on page 250](#)) to specify whether ports are trusted or untrusted ports for DHCP snooping.
- Use the **DHCP Snooping VLAN Configure** screen ([Section 27.3.2 on page 251](#)) to enable DHCP snooping on each VLAN and to specify whether or not the Switch adds DHCP relay agent option 82 information to DHCP requests that the Switch relays to a DHCP server for each VLAN.
- Use the **DHCP Snooping VLAN Port Configure** screen ([Section 27.3.3 on page 252](#)) to apply a different DHCP option 82 profile to certain ports in a VLAN.

27.2 DHCP Snooping

Use this screen to look at various statistics about the DHCP snooping database.

To open this screen, click **Advanced Application > IP Source Guard > IPv4 Source Guard Setup > DHCP Snooping**.

Figure 178 Advanced Application > IP Source Guard > IPv4 Source Guard Setup > DHCP Snooping

DHCP Snooping		IPv4 SG	Configure
Database Status			
Description	Status		
Agent URL			
Write delay timer	300	seconds	
Abort timer	300	seconds	
Agent running	None		
Delay timer expiry	Not Running		
Abort timer expiry	Not Running		
Last succeeded time	None		
Last failed time	None		
Last failed reason	No failure recorded		
Times			
Total attempts	0		
Startup failures	0		
Successful transfers	0		
Failed transfers	0		
Successful reads	0		
Failed reads	0		
Successful writes	0		
Failed writes	0		
Database detail			
Description	Status		
First successful access	None		
Last ignored bindings counters			
Binding collisions	0		
Invalid interfaces	0		
Parse failures	0		
Expired leases	0		
Unsupported vlans	0		
Last ignored time	None		
Total ignored bindings counters			
Binding collisions	0		
Invalid interfaces	0		
Parse failures	0		
Expired leases	0		
Unsupported vlans	0		

The following table describes the labels in this screen.

Table 107 Advanced Application > IP Source Guard > IPv4 Source Guard Setup > DHCP Snooping

LABEL	DESCRIPTION
Database Status	
	This section displays the current settings for the DHCP snooping database. You can configure them in the DHCP Snooping Configure screen.
Agent URL	This field displays the location of the DHCP snooping database.
Write delay timer	This field displays how long (in seconds) the Switch tries to complete a specific update in the DHCP snooping database before it gives up.
Abort timer	This field displays how long (in seconds) the Switch waits to update the DHCP snooping database after the current bindings change.
	This section displays information about the current update and the next update of the DHCP snooping database.

Table 107 Advanced Application > IP Source Guard > IPv4 Source Guard Setup > DHCP Snooping

LABEL	DESCRIPTION
Agent running	This field displays the status of the current update or access of the DHCP snooping database. none: The Switch is not accessing the DHCP snooping database. read: The Switch is loading dynamic bindings from the DHCP snooping database. write: The Switch is updating the DHCP snooping database.
Delay timer expiry	This field displays how much longer (in seconds) the Switch tries to complete the current update before it gives up. It displays Not Running if the Switch is not updating the DHCP snooping database right now.
Abort timer expiry	This field displays when (in seconds) the Switch is going to update the DHCP snooping database again. It displays Not Running if the current bindings have not changed since the last update.
	This section displays information about the last time the Switch updated the DHCP snooping database.
Last succeeded time	This field displays the last time the Switch updated the DHCP snooping database successfully.
Last failed time	This field displays the last time the Switch updated the DHCP snooping database unsuccessfully.
Last failed reason	This field displays the reason the Switch updated the DHCP snooping database unsuccessfully.
	This section displays historical information about the number of times the Switch successfully or unsuccessfully read or updated the DHCP snooping database.
Total attempts	This field displays the number of times the Switch has tried to access the DHCP snooping database for any reason.
Startup failures	This field displays the number of times the Switch could not create or read the DHCP snooping database when the Switch started up or a new URL is configured for the DHCP snooping database.
Successful transfers	This field displays the number of times the Switch read bindings from or updated the bindings in the DHCP snooping database successfully.
Failed transfers	This field displays the number of times the Switch was unable to read bindings from or update the bindings in the DHCP snooping database.
Successful reads	This field displays the number of times the Switch read bindings from the DHCP snooping database successfully.
Failed reads	This field displays the number of times the Switch was unable to read bindings from the DHCP snooping database.
Successful writes	This field displays the number of times the Switch updated the bindings in the DHCP snooping database successfully.
Failed writes	This field displays the number of times the Switch was unable to update the bindings in the DHCP snooping database.
Database detail	
First successful access	This field displays the first time the Switch accessed the DHCP snooping database for any reason.
Last ignored bindings counters	This section displays the number of times and the reasons the Switch ignored bindings the last time it read bindings from the DHCP binding database. You can clear these counters by restarting the Switch or using CLI commands. See the Ethernet Switch CLI Reference Guide.
Binding collisions	This field displays the number of bindings the Switch ignored because the Switch already had a binding with the same MAC address and VLAN ID.
Invalid interfaces	This field displays the number of bindings the Switch ignored because the port number was a trusted interface or does not exist anymore.
Parse failures	This field displays the number of bindings the Switch ignored because the Switch was unable to understand the binding in the DHCP binding database.

Table 107 Advanced Application > IP Source Guard > IPv4 Source Guard Setup > DHCP Snooping

LABEL	DESCRIPTION
Expired leases	This field displays the number of bindings the Switch ignored because the lease time had already expired.
Unsupported vlans	This field displays the number of bindings the Switch ignored because the VLAN ID does not exist anymore.
Last ignored time	This field displays the last time the Switch ignored any bindings for any reason from the DHCP binding database.
Total ignored bindings counters	This section displays the reasons the Switch has ignored bindings any time it read bindings from the DHCP binding database. You can clear these counters by restarting the Switch or using CLI commands. See the Ethernet Switch CLI Reference Guide.
Binding collisions	This field displays the number of bindings the Switch has ignored because the Switch already had a binding with the same MAC address and VLAN ID.
Invalid interfaces	This field displays the number of bindings the Switch has ignored because the port number was a trusted interface or does not exist anymore.
Parse failures	This field displays the number of bindings the Switch has ignored because the Switch was unable to understand the binding in the DHCP binding database.
Expired leases	This field displays the number of bindings the Switch has ignored because the lease time had already expired.
Unsupported vlans	This field displays the number of bindings the Switch has ignored because the VLAN ID does not exist anymore.

27.3 DHCP Snooping Configure

Use this screen to enable DHCP snooping on the Switch (not on specific VLAN), specify the VLAN where the default DHCP server is located, and configure the DHCP snooping database. The DHCP snooping database stores the current bindings on a secure, external TFTP server so that they are still available after a restart.

To open this screen, click **Advanced Application > IP Source Guard > IPv4 Source Guard Setup > DHCP Snooping > Configure**.

Figure 179 Advanced Application > IP Source Guard > IPv4 Source Guard Setup > DHCP Snooping > Configure

The screenshot shows the 'DHCP Snooping Configure' interface. At the top, there are tabs for 'DHCP Snooping', 'Port', and 'VLAN'. The 'Active' checkbox is unchecked. Below it, the 'DHCP Vlan' section has a radio button selected for 'Disable' and an empty text box. The 'Database' section includes fields for 'Agent URL', 'Timeout interval' (300 seconds), and 'Write delay interval' (300 seconds). At the bottom, there is a 'Renew DHCP Snooping URL' field with a 'Renew' button, and 'Apply' and 'Cancel' buttons.

The following table describes the labels in this screen.

Table 108 Advanced Application > IP Source Guard > IPv4 Source Guard Setup > DHCP Snooping > Configure

LABEL	DESCRIPTION
Active	<p>Select this to enable DHCP snooping on the Switch. You still have to enable DHCP snooping on specific VLAN and specify trusted ports.</p> <p>Note: The Switch will drop all DHCP requests if you enable DHCP snooping and there are no trusted ports.</p>
DHCP Vlan	<p>Select a VLAN ID if you want the Switch to forward DHCP packets to DHCP servers on a specific VLAN.</p> <p>Note: You have to enable DHCP snooping on the DHCP VLAN too.</p> <p>You can select an option 82 profile in the DHCP Snooping VLAN Configure screen to help the DHCP servers distinguish between DHCP requests from different VLAN.</p> <p>Select Disable if you do not want the Switch to forward DHCP packets to a specific VLAN.</p>
Database	<p>If Timeout interval is greater than Write delay interval, it is possible that the next update is scheduled to occur before the current update has finished successfully or timed out. In this case, the Switch waits to start the next update until it completes the current one.</p>
Agent URL	<p>Enter the location of the DHCP snooping database. The location should be expressed like this: tftp://{domain name or IP address}/directory, if applicable/file name; for example, tftp://192.168.10.1/database.txt.</p>
Timeout interval	<p>Enter how long (10 – 65535 seconds) the Switch tries to complete a specific update in the DHCP snooping database before it gives up.</p>
Write delay interval	<p>Enter how long (10 – 65535 seconds) the Switch waits to update the DHCP snooping database the first time the current bindings change after an update. Once the next update is scheduled, additional changes in current bindings are automatically included in the next update.</p>
Renew DHCP Snooping URL	<p>Enter the location of a DHCP snooping database, and click Renew if you want the Switch to load it. You can use this to load dynamic bindings from a different DHCP snooping database than the one specified in Agent URL.</p> <p>When the Switch loads dynamic bindings from a DHCP snooping database, it does not discard the current dynamic bindings first. If there is a conflict, the Switch keeps the dynamic binding in volatile memory and updates the Binding collisions counter in the DHCP Snooping screen.</p>
Apply	<p>Click Apply to save your changes to the Switch's run-time memory. The Switch loses these changes if it is turned off or loses power, so use the Save link on the top navigation panel to save your changes to the non-volatile memory when you are done configuring.</p>
Cancel	<p>Click this to reset the values in this screen to their last-saved values.</p>

27.3.1 DHCP Snooping Port Configure

Use this screen to specify whether ports are trusted or untrusted ports for DHCP snooping.

Note: If DHCP snooping is enabled but there are no trusted ports, DHCP requests cannot reach the DHCP server.

You can also specify the maximum number for DHCP packets that each port (trusted or untrusted) can receive each second.

To open this screen, click **Advanced Application > IP Source Guard > IPv4 Source Guard Setup > DHCP Snooping > Configure > Port**.

Figure 180 Advanced Application > IP Source Guard > IPv4 Source Guard Setup > DHCP Snooping > Configure > Port

Port	Server Trusted state	Rate (pps)
*	Untrusted ▼	
1	Untrusted ▼	0
2	Untrusted ▼	0
3	Untrusted ▼	0
4	Untrusted ▼	0
5	Untrusted ▼	0
6	Untrusted ▼	0
7	Untrusted ▼	0
8	Untrusted ▼	0
9	Untrusted ▼	0

The following table describes the labels in this screen.

Table 109 Advanced Application > IP Source Guard > IPv4 Source Guard Setup > DHCP Snooping > Configure > Port

LABEL	DESCRIPTION
Port	This field displays the port number.
*	Settings in this row apply to all ports. Use this row only if you want to make some settings the same for all ports. Use this row first to set the common settings and then make adjustments on a port-by-port basis. Note: Changes in this row are copied to all the ports as soon as you make them.
Server Trusted state	Select whether this port is a trusted port (Trusted) or an untrusted port (Untrusted). Trusted ports are connected to DHCP servers or other switches, and the Switch discards DHCP packets from trusted ports only if the rate at which DHCP packets arrive is too high. Untrusted ports are connected to subscribers, and the Switch discards DHCP packets from untrusted ports in the following situations: <ul style="list-style-type: none"> • The packet is a DHCP server packet (for example, OFFER, ACK, or NACK). • The source MAC address and source IP address in the packet do not match any of the current bindings. • The packet is a RELEASE or DECLINE packet, and the source MAC address and source port do not match any of the current bindings. • The rate at which DHCP packets arrive is too high.
Rate (pps)	Specify the maximum number for DHCP packets (1 – 2048) that the Switch receives from each port each second. The Switch discards any additional DHCP packets. Enter 0 to disable this limit, which is recommended for trusted ports.
Apply	Click Apply to save your changes to the Switch's run-time memory. The Switch loses these changes if it is turned off or loses power, so use the Save link on the top navigation panel to save your changes to the non-volatile memory when you are done configuring.
Cancel	Click this to reset the values in this screen to their last-saved values.

27.3.2 DHCP Snooping VLAN Configure

Use this screen to enable DHCP snooping on each VLAN and to specify whether or not the Switch adds DHCP relay agent option 82 information to DHCP requests that the Switch relays to a DHCP server for each VLAN.

To open this screen, click **Advanced Application > IP Source Guard > IPv4 Source Guard Setup > DHCP Snooping > Configure > VLAN**.

Figure 181 Advanced Application > IP Source Guard > IPv4 Source Guard Setup > DHCP Snooping > Configure > VLAN

The following table describes the labels in this screen.

Table 110 Advanced Application > IP Source Guard > IPv4 Source Guard Setup > DHCP Snooping > Configure > VLAN

LABEL	DESCRIPTION
VLAN Search by VID	Enter the VLAN ID you want to manage. Use a comma (,) to separate individual VLANs or a dash (-) to indicates a range of VLANs. For example, "3,4" or "3-9".
Search	Click this to display the specified range of VLANs in the section below.
VID	This field displays the VLAN ID of each VLAN in the range specified above. If you configure the * VLAN, the settings are applied to all VLANs.
Enabled	Select Yes to enable DHCP snooping on the VLAN. You still have to enable DHCP snooping on the Switch and specify trusted ports. Note: The Switch will drop all DHCP requests if you enable DHCP snooping and there are no trusted ports.
Option 82 Profile	Select a pre-defined DHCP option 82 profile that the Switch applies to all ports in the specified VLANs. The Switch adds the information (such as slot number, port number, VLAN ID and/or system name) specified in the profile to DHCP requests that it broadcasts to the DHCP VLAN, if specified, or VLAN. You can specify the DHCP VLAN in the DHCP Snooping Configure screen.
Apply	Click Apply to save your changes to the Switch's run-time memory. The Switch loses these changes if it is turned off or loses power, so use the Save link on the top navigation panel to save your changes to the non-volatile memory when you are done configuring.
Cancel	Click this to reset the values in this screen to their last-saved values.
Change Pages	Click Previous or Next to show the previous/next screen if all status information cannot be seen in one screen.

27.3.3 DHCP Snooping VLAN Port Configure

Use this screen to apply a different DHCP option 82 profile to certain ports in a VLAN.

To open this screen, click **Advanced Application > IP Source Guard > IPv4 Source Guard Setup > DHCP Snooping > Configure > VLAN > Port**.

Figure 182 Advanced Application > IP Source Guard > IPv4 Source Guard Setup > DHCP Snooping > Configure > VLAN > Port

The following table describes the labels in this screen.

Table 111 Advanced Application > IP Source Guard > IPv4 Source Guard Setup > DHCP Snooping > Configure > VLAN > Port

LABEL	DESCRIPTION
VID	Enter the ID number of the VLAN you want to configure here.
Port	Enter the number of ports to which you want to apply the specified DHCP option 82 profile. You can enter multiple ports separated by (no space) comma (,) or hyphen (-) for a range. For example, enter "3-5" for ports 3, 4, and 5. Enter "3,5,7" for ports 3, 5, and 7.
Option 82 Profile	Select a pre-defined DHCP option 82 profile that the Switch applies to the specified ports in this VLAN. The Switch adds the information (such as slot number, port number, VLAN ID and/or system name) specified in the profile to DHCP requests that it broadcasts to the DHCP VLAN, if specified, or VLAN. You can specify the DHCP VLAN in the DHCP Snooping Configure screen. Note: The profile you select here has priority over the one you select in the DHCP Snooping > Configure > VLAN screen.
Add	Click this to create a new entry or to update an existing one. This saves your changes to the Switch's run-time memory. The Switch loses these changes if it is turned off or loses power, so use the Save link on the top navigation panel to save your changes to the non-volatile memory when you are done configuring.
Cancel	Click this to reset the values above based on the last selected entry or, if not applicable, to clear the fields above.
Clear	Click Clear to reset the fields to the factory defaults.
Index	This field displays a sequential number for each entry. Click an index number to change the settings.
VID	This field displays the VLAN to which the ports belongs.
Port	This field displays the ports to which the Switch applies the settings.
Profile Name	This field displays the DHCP option 82 profile that the Switch applies to the ports.
Delete	Select the entries that you want to remove in the Delete column, and then click the Delete button to remove the selected entries from the table.
Cancel	Click this to clear the Delete check boxes above.

27.4 Technical Reference

This section provides technical background information on the topics discussed in this chapter.

27.4.1 DHCP Snooping Overview

Use DHCP snooping to filter unauthorized DHCP packets on the network and to build the binding table dynamically. This can prevent clients from getting IP addresses from unauthorized DHCP servers.

27.4.1.1 Trusted vs. Untrusted Ports

Every port is either a trusted port or an untrusted port for DHCP snooping. This setting is independent of the trusted or untrusted setting for ARP inspection. You can also specify the maximum number for DHCP packets that each port (trusted or untrusted) can receive each second.

Trusted ports are connected to DHCP servers or other switches. The Switch discards DHCP packets from trusted ports only if the rate at which DHCP packets arrive is too high. The Switch learns dynamic bindings from trusted ports.

Note: If DHCP is enabled and there are no trusted ports, DHCP requests will not succeed.

Untrusted ports are connected to subscribers. The Switch discards DHCP packets from untrusted ports in the following situations:

- The packet is a DHCP server packet (for example, OFFER, ACK, or NACK).
- The source MAC address and source IP address in the packet do not match any of the current bindings.
- The packet is a RELEASE or DECLINE packet, and the source MAC address and source port do not match any of the current bindings.
- The rate at which DHCP packets arrive is too high.

27.4.1.2 DHCP Snooping Database

The Switch stores the binding table in volatile memory. If the Switch restarts, it loads static bindings from permanent memory but loses the dynamic bindings, in which case the devices in the network have to send DHCP requests again. As a result, it is recommended you configure the DHCP snooping database.

The DHCP snooping database maintains the dynamic bindings for DHCP snooping and ARP inspection in a file on an external TFTP server. If you set up the DHCP snooping database, the Switch can reload the dynamic bindings from the DHCP snooping database after the Switch restarts.

You can configure the name and location of the file on the external TFTP server. The file has the following format:

Figure 183 DHCP Snooping Database File Format

```
<initial-checksum>
TYPE DHCP-SNOOPING
VERSION 1
BEGIN
<binding-1> <checksum-1>
<binding-2> <checksum-1-2>
...
...
<binding-n> <checksum-1-2-...-n>
END
```

The <initial-checksum> helps distinguish between the bindings in the latest update and the bindings from previous updates. Each binding consists of 72 bytes, a space, and another checksum that is used to validate the binding when it is read. If the calculated checksum is not equal to the checksum in the

file, that binding and all others after it are ignored.

27.4.1.3 DHCP Relay Option 82 Information

The Switch can add information to DHCP requests that it does not discard. This provides the DHCP server more information about the source of the requests. The Switch can add the following information:

- Slot ID (1 byte), port ID (1 byte), and source VLAN ID (2 bytes)
- System name (up to 32 bytes)

This information is stored in an Agent Information field in the option 82 field of the DHCP headers of client DHCP request frames.

When the DHCP server responds, the Switch removes the information in the Agent Information field before forwarding the response to the original source.

You can configure this setting for each source VLAN. This setting is independent of the DHCP relay settings.

27.4.1.4 Configuring DHCP Snooping

Follow these steps to configure DHCP snooping on the Switch.

- 1 Enable DHCP snooping on the Switch.
- 2 Enable DHCP snooping on each VLAN, and configure DHCP relay option 82.
- 3 Configure trusted and untrusted ports, and specify the maximum number of DHCP packets that each port can receive per second.
- 4 Configure static bindings.

CHAPTER 28

ARP Inspection

28.1 ARP Inspection Status

Use this screen to look at the current list of MAC address filters that were created because the Switch identified an unauthorized ARP packet. When the Switch identifies an unauthorized ARP packet, it automatically creates a MAC address filter to block traffic from the source MAC address and source VLAN ID of the unauthorized ARP packet. To open this screen, click **Advanced Application > IP Source Guard > IPv4 Source Guard Setup > ARP Inspection**.

Figure 184 Advanced Application > IP Source Guard > IPv4 Source Guard Setup > ARP Inspection Status

The following table describes the labels in this screen.

Table 112 Advanced Application > IP Source Guard > IPv4 Source Guard Setup > ARP Inspection Status

LABEL	DESCRIPTION
Total number of filters	This field displays the current number of MAC address filters that were created because the Switch identified unauthorized ARP packets.
Index	This field displays a sequential number for each MAC address filter.
MAC Address	This field displays the source MAC address in the MAC address filter.
VID	This field displays the source VLAN ID in the MAC address filter.
Port	This field displays the source port of the discarded ARP packet.
Expiry (sec)	This field displays how long (in seconds) the MAC address filter remains in the Switch. You can also delete the record manually (Delete).
	Select an entry's check box to select a specific entry. Otherwise, select the check box in the table heading row to select all entries.
Delete	Click this to remove the selected entries.
Cancel	Click this to clear the Delete check boxes above.
Change Pages	Click Previous Page or Next Page to show the previous or next screen if all status information cannot be seen in one screen.

28.1.1 ARP Inspection VLAN Status

Use this screen to look at various statistics about ARP packets in each VLAN. To open this screen, click **Advanced Application > IP Source Guard > IPv4 Source Guard Setup > ARP Inspection > VLAN Status**.

Figure 185 Advanced Application > IP Source Guard > IPv4 Source Guard Setup > ARP Inspection > VLAN Status

The following table describes the labels in this screen.

Table 113 Advanced Application > IP Source Guard > IPv4 Source Guard Setup > ARP Inspection > VLAN Status

LABEL	DESCRIPTION
VLAN Search by VID	Specify the VLANs you want to view in the section below. Use a comma (,) to separate individual VLANs or a dash (-) to indicates a range of VLANs. For example, "3,4" or "3-9".
Search	Click this to display the specified range of VLANs in the section below.
The Number of VLAN	This is the number of VLANs that match the searching criteria and display in the list below. This field displays only when you use the Search button to look for certain VLANs.
VID	This field displays the VLAN ID of each VLAN in the range specified above.
Received	This field displays the total number of ARP packets received from the VLAN since the Switch last restarted.
Request	This field displays the total number of ARP Request packets received from the VLAN since the Switch last restarted.
Reply	This field displays the total number of ARP Reply packets received from the VLAN since the Switch last restarted.
Forwarded	This field displays the total number of ARP packets the Switch forwarded for the VLAN since the Switch last restarted.
Dropped	This field displays the total number of ARP packets the Switch discarded for the VLAN since the Switch last restarted.
Change Pages	Click Previous or Next to show the previous/next screen if all status information cannot be seen in one screen.

28.1.2 ARP Inspection Log Status

Use this screen to look at log messages that were generated by ARP packets and that have not been sent to the syslog server yet. To open this screen, click **Advanced Application > IP Source Guard > IPv4 Source Guard Setup > ARP Inspection > Log Status**.

Figure 186 Advanced Application > IP Source Guard > IPv4 Source Guard Setup > ARP Inspection > Log Status

Index	Port	VID	Sender MAC	Sender IP	Num Pkts	Reason	Time
-------	------	-----	------------	-----------	----------	--------	------

The following table describes the labels in this screen.

Table 114 Advanced Application > IP Source Guard > IPv4 Source Guard Setup > ARP Inspection > Log Status

LABEL	DESCRIPTION
Clearing log status table	Click Apply to remove all the log messages that were generated by ARP packets and that have not been sent to the syslog server yet.
Total number of logs	This field displays the number of log messages that were generated by ARP packets and that have not been sent to the syslog server yet. If one or more log messages are dropped due to unavailable buffer, there is an entry called overflow with the current number of dropped log messages.
Index	This field displays a sequential number for each log message.
Port	This field displays the source port of the ARP packet.
VID	This field displays the source VLAN ID of the ARP packet.
Sender MAC	This field displays the source MAC address of the ARP packet.
Sender IP	This field displays the source IP address of the ARP packet.
Num Pkts	This field displays the number of ARP packets that were consolidated into this log message. The Switch consolidates identical log messages generated by ARP packets in the log consolidation interval into one log message. You can configure this interval in the ARP Inspection Configure screen.
Reason	This field displays the reason the log message was generated. dhcp deny: An ARP packet was discarded because it violated a dynamic binding with the same MAC address and VLAN ID. static deny: An ARP packet was discarded because it violated a static binding with the same MAC address and VLAN ID. deny: An ARP packet was discarded because there were no bindings with the same MAC address and VLAN ID. dhcp permit: An ARP packet was forwarded because it matched a dynamic binding. static permit: An ARP packet was forwarded because it matched a static binding. In the ARP Inspection VLAN Configure screen, you can configure the Switch to generate log messages when ARP packets are discarded or forwarded based on the VLAN ID of the ARP packet.
Time	This field displays when the log message was generated.

28.2 ARP Inspection Configure

Use this screen to enable ARP inspection on the Switch. You can also configure the length of time the Switch stores records of discarded ARP packets and global settings for the ARP inspection log. To open this screen, click **Advanced Application > IP Source Guard > IPv4 Source Guard Setup > ARP Inspection >**

Configure.**Figure 187** Advanced Application > IP Source Guard > IPv4 Source Guard Setup > ARP Inspection > Configure

The following table describes the labels in this screen.

Table 115 Advanced Application > IP Source Guard > IPv4 Source Guard Setup > ARP Inspection > Configure

LABEL	DESCRIPTION
Active	Select this to enable ARP inspection on the Switch. You still have to enable ARP inspection on specific VLAN and specify trusted ports.
Filter Aging Time	
Filter aging time	This setting has no effect on existing MAC address filters. Enter how long (1 – 2147483647 seconds) the MAC address filter remains in the Switch after the Switch identifies an unauthorized ARP packet. The Switch automatically deletes the MAC address filter afterwards. Type 0 if you want the MAC address filter to be permanent.
Log Profile	
Log buffer size	Enter the maximum number (1 – 1024) of log messages that were generated by ARP packets and have not been sent to the syslog server yet. Make sure this number is appropriate for the specified Syslog rate and Log interval . If the number of log messages in the Switch exceeds this number, the Switch stops recording log messages and simply starts counting the number of entries that were dropped due to unavailable buffer. Click Clearing log status table in the ARP Inspection Log Status screen to clear the log and reset this counter.
Syslog rate	Type the maximum number of syslog messages the Switch can send to the syslog server in one batch. This number is expressed as a rate because the batch frequency is determined by the Log Interval . You must configure the syslog server to use this. Enter 0 if you do not want the Switch to send log messages generated by ARP packets to the syslog server. The relationship between Syslog rate and Log interval is illustrated in the following examples: <ul style="list-style-type: none"> Four invalid ARP packets per second, Syslog rate is 5, Log interval is 1: the Switch sends 4 syslog messages every second. Six invalid ARP packets per second, Syslog rate is 5, Log interval is 2: the Switch sends 5 syslog messages every 2 seconds.
Log interval	Type how often (1 – 86400 seconds) the Switch sends a batch of syslog messages to the syslog server. Enter 0 if you want the Switch to send syslog messages immediately. See Syslog rate for an example of the relationship between Syslog rate and Log interval .

Table 115 Advanced Application > IP Source Guard > IPv4 Source Guard Setup > ARP Inspection > Configure (continued)

LABEL	DESCRIPTION
Apply	Click Apply to save your changes to the Switch's run-time memory. The Switch loses these changes if it is turned off or loses power, so use the Save link on the top navigation panel to save your changes to the non-volatile memory when you are done configuring.
Cancel	Click this to reset the values in this screen to their last-saved values.

28.2.1 ARP Inspection Port Configure

Use this screen to specify whether ports are trusted or untrusted ports for ARP inspection. You can also specify the maximum rate at which the Switch receives ARP packets on each untrusted port. To open this screen, click **Advanced Application > IP Source Guard > IPv4 Source Guard Setup > ARP Inspection > Configure > Port**.

Figure 188 Advanced Application > IP Source Guard > IPv4 Source Guard Setup > ARP Inspection > Configure > Port

Port	Trusted State	Rate (pps)	Limit Burst interval (seconds)
*	Untrusted ▼		
1	Untrusted ▼	15	1
2	Untrusted ▼	15	1
3	Untrusted ▼	15	1
4	Untrusted ▼	15	1
5	Untrusted ▼	15	1
6	Untrusted ▼	15	1
7	Untrusted ▼	15	1
8	Untrusted ▼	15	1
9	Untrusted ▼	15	1

The following table describes the labels in this screen.

Table 116 Advanced Application > IP Source Guard > IPv4 Source Guard Setup > ARP Inspection > Configure > Port

LABEL	DESCRIPTION
Port	This field displays the port number.
*	Settings in this row apply to all ports. Use this row only if you want to make some settings the same for all ports. Use this row first to set the common settings and then make adjustments on a port-by-port basis. Note: Changes in this row are copied to all the ports as soon as you make them.
Trusted State	Select whether this port is a trusted port (Trusted) or an untrusted port (Untrusted). The Switch does not discard ARP packets on trusted ports for any reason. The Switch discards ARP packets on untrusted ports in the following situations: <ul style="list-style-type: none"> The sender's information in the ARP packet does not match any of the current bindings. The rate at which ARP packets arrive is too high. You can specify the maximum rate at which ARP packets can arrive on untrusted ports.
Limit	Rate and Burst Interval settings have no effect on trusted ports.

Table 116 Advanced Application > IP Source Guard > IPv4 Source Guard Setup > ARP Inspection > Configure > Port (continued)

LABEL	DESCRIPTION
Rate (pps)	Specify the maximum rate (1 – 2048 packets per second) at which the Switch receives ARP packets from each port. The Switch discards any additional ARP packets. Enter 0 to disable this limit.
Burst interval (seconds)	The burst interval is the length of time over which the rate of ARP packets is monitored for each port. For example, if the Rate is 15 pps and the burst interval is 1 second, then the Switch accepts a maximum of 15 ARP packets in every one-second interval. If the burst interval is 5 seconds, then the Switch accepts a maximum of 75 ARP packets in every five-second interval. Enter the length (1 – 15 seconds) of the burst interval.
Apply	Click Apply to save your changes to the Switch's run-time memory. The Switch loses these changes if it is turned off or loses power, so use the Save link on the top navigation panel to save your changes to the non-volatile memory when you are done configuring.
Cancel	Click this to reset the values in this screen to their last-saved values.

28.2.2 ARP Inspection VLAN Configure

Use this screen to enable ARP inspection on each VLAN and to specify when the Switch generates log messages for receiving ARP packets from each VLAN. To open this screen, click **Advanced Application > IP Source Guard > IPv4 Source Guard Setup > ARP Inspection > Configure > VLAN**.

Figure 189 Advanced Application > IP Source Guard > IPv4 Source Guard Setup > ARP Inspection > Configure > VLAN

The following table describes the labels in this screen.

Table 117 Advanced Application > IP Source Guard > IPv4 Source Guard Setup > ARP Inspection > Configure > VLAN

LABEL	DESCRIPTION
VLAN Search by VID	Specify the VLANs you want to manage in the section below. Use a comma (,) to separate individual VLANs or a dash (-) to indicate a range of VLANs. For example, "3,4" or "3-9".
Search	Click this to display the specified range of VLANs in the section below.
VID	This field displays the VLAN ID of each VLAN in the range specified above. If you configure the * VLAN, the settings are applied to all VLANs.
Enabled	Select Yes to enable ARP inspection on the VLAN. Select No to disable ARP inspection on the VLAN.

Table 117 Advanced Application > IP Source Guard > IPv4 Source Guard Setup > ARP Inspection > Configure > VLAN (continued)

LABEL	DESCRIPTION
Log	Specify when the Switch generates log messages for receiving ARP packets from the VLAN. None: The Switch does not generate any log messages when it receives an ARP packet from the VLAN. Deny: The Switch generates log messages when it discards an ARP packet from the VLAN. Permit: The Switch generates log messages when it forwards an ARP packet from the VLAN. All: The Switch generates log messages every time it receives an ARP packet from the VLAN.
Apply	Click Apply to save your changes to the Switch's run-time memory. The Switch loses these changes if it is turned off or loses power, so use the Save link on the top navigation panel to save your changes to the non-volatile memory when you are done configuring.
Cancel	Click this to reset the values in this screen to their last-saved values.
Change Pages	Click Previous or Next to show the previous or next screen if all status information cannot be seen in one screen.

28.3 Technical Reference

This section provides technical background information on the topics discussed in this chapter.

28.3.1 ARP Inspection Overview

Use ARP inspection to filter unauthorized ARP packets on the network. This can prevent many kinds of man-in-the-middle attacks, such as the one in the following example.

Figure 190 Example: Man-in-the-middle Attack

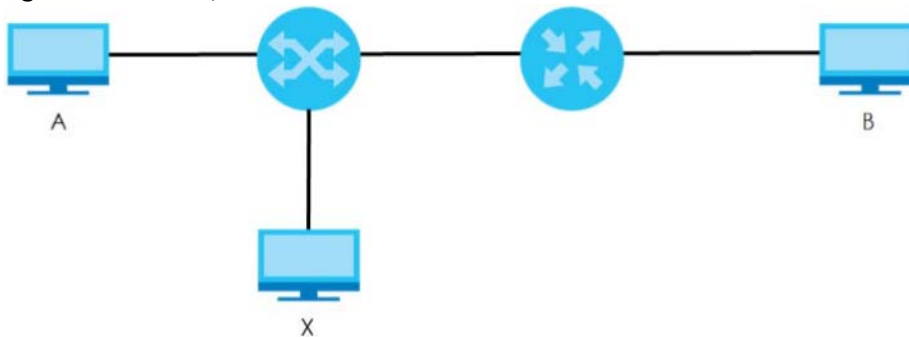

In this example, computer **B** tries to establish a connection with computer **A**. Computer **X** is in the same broadcast domain as computer **A** and intercepts the ARP request for computer **A**. Then, computer **X** does the following things:

- It pretends to be computer **A** and responds to computer **B**.
- It pretends to be computer **B** and sends a message to computer **A**.

As a result, all the communication between computer **A** and computer **B** passes through computer **X**. Computer **X** can read and alter the information passed between them.

28.3.1.1 ARP Inspection and MAC Address Filters

When the Switch identifies an unauthorized ARP packet, it automatically creates a MAC address filter to

block traffic from the source MAC address and source VLAN ID of the unauthorized ARP packet. You can configure how long the MAC address filter remains in the Switch.

These MAC address filters are different than regular MAC address filters.

- They are stored only in volatile memory.
- They do not use the same space in memory that regular MAC address filters use.
- They appear only in the **ARP Inspection** screens and commands, not in the **MAC Address Filter** screens and commands.

28.3.1.2 Trusted vs. Untrusted Ports

Every port is either a trusted port or an untrusted port for ARP inspection. This setting is independent of the trusted or untrusted setting for DHCP snooping. You can also specify the maximum rate at which the Switch receives ARP packets on untrusted ports.

The Switch does not discard ARP packets on trusted ports for any reason.

The Switch discards ARP packets on untrusted ports in the following situations:

- The sender's information in the ARP packet does not match any of the current bindings.
- The rate at which ARP packets arrive is too high.

28.3.1.3 Syslog

The Switch can send syslog messages to the specified syslog server when it forwards or discards ARP packets. The Switch can consolidate log messages and send log messages in batches to make this mechanism more efficient.

28.3.1.4 Configuring ARP Inspection

Follow these steps to configure ARP inspection on the Switch.

- 1 Configure DHCP snooping.

Note: It is recommended you enable DHCP snooping at least one day before you enable ARP inspection so that the Switch has enough time to build the binding table.

- 2 Enable ARP inspection on each VLAN.
- 3 Configure trusted and untrusted ports, and specify the maximum number of ARP packets that each port can receive per second.

CHAPTER 29

Loop Guard

29.1 Loop Guard Overview

This chapter shows you how to configure the Switch to guard against loops on the edge of your network.

Loop guard allows you to configure the Switch to shut down a port if it detects that packets sent out on that port loop back to the Switch. While you can use Spanning Tree Protocol (STP) to prevent loops in the core of your network, STP cannot prevent loops that occur on the edge of your network.

Figure 191 Loop Guard vs. STP

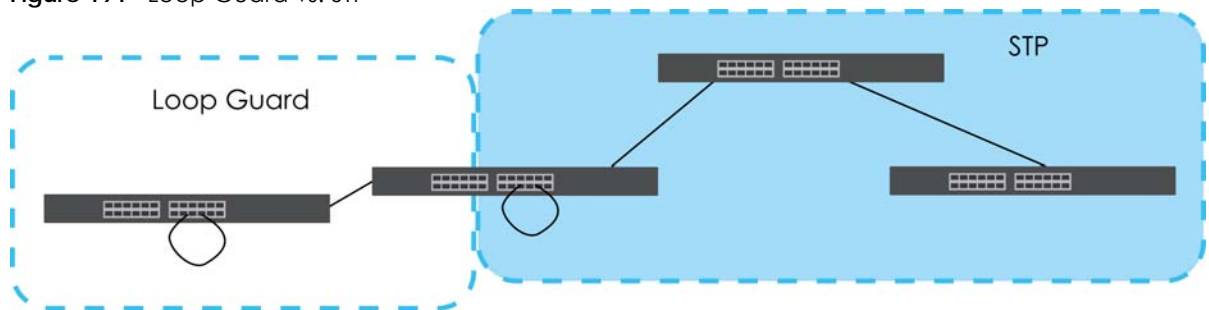

Refer to [Section 29.1.2 on page 264](#) for more information.

29.1.1 What You Can Do

Use the **Loop Guard** screen ([Section 29.2 on page 266](#)) to enable loop guard on the Switch and in specific ports.

29.1.2 What You Need to Know

Loop guard is designed to handle loop problems on the edge of your network. This can occur when a port is connected to a Switch that is in a loop state. Loop state occurs as a result of human error. It happens when two ports on a switch are connected with the same cable. When a switch in loop state sends out broadcast messages the messages loop back to the switch and are re-broadcast again and again causing a broadcast storm.

If a switch (not in loop state) connects to a switch in loop state, then it will be affected by the switch in loop state in the following way:

- The switch (not in loop state) will receive broadcast messages sent out from the switch in loop state.
- The switch (not in loop state) will receive its own broadcast messages that it sends out as they loop back. It will then re-broadcast those messages again.

The following figure shows port **N** on switch **A** connected to switch **B**. Switch **B** has two ports, **x** and **y**, mistakenly connected to each other. It forms a loop. When broadcast or multicast packets leave port **N**

and reach switch B, they are sent back to port N on A as they are rebroadcast from B.

Figure 192 Switch in Loop State

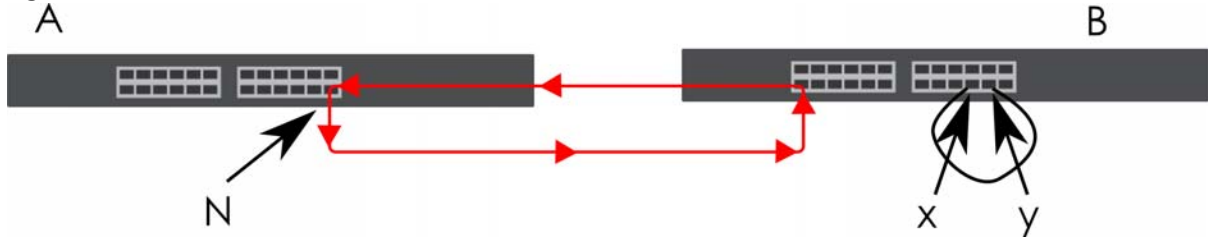

The loop guard feature checks to see if a loop guard enabled port is connected to a Switch in loop state. This is accomplished by periodically sending a probe packet and seeing if the packet returns on the same port. If this is the case, the Switch will shut down the port connected to the switch in loop state.

Loop guard can be enabled on both Ethernet ports. The following figure shows a loop guard enabled port N on switch A sending a probe packet P to switch B. Since switch B is in loop state, the probe packet P returns to port N on A. The Switch then shuts down port N to ensure that the rest of the network is not affected by the switch in loop state.

Figure 193 Loop Guard – Probe Packet

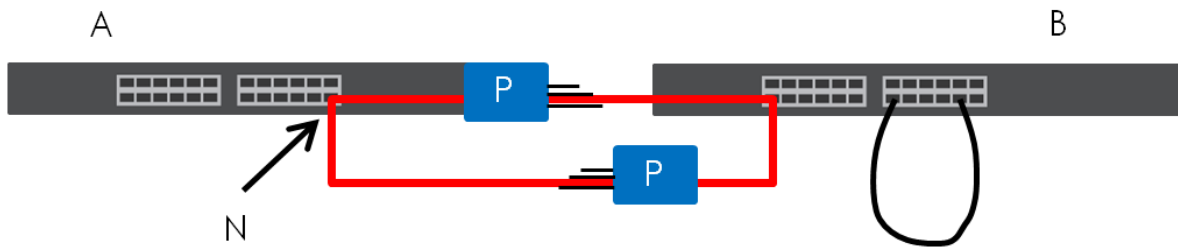

The Switch also shuts down port N if the probe packet returns to switch A on any other port. In other words loop guard also protects against standard network loops.

The following figure illustrates three switches forming a loop. A sample path of the loop guard probe packet is also shown. In this example, the probe packet is sent from port N and returns on another port. As long as loop guard is enabled on port N. The Switch will shut down port N if it detects that the probe packet has returned to the Switch.

Figure 194 Loop Guard – Network Loop

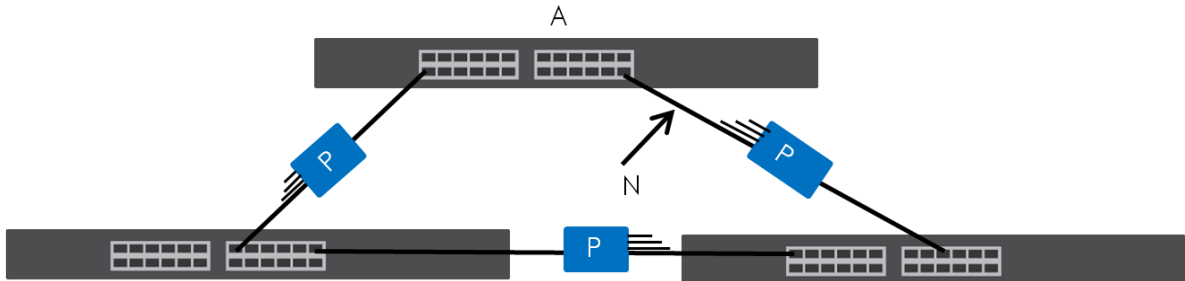

Note: After resolving the loop problem on your network you can re-activate the disabled port via the Web Configurator (see [Section 8.7 on page 92](#)) or via commands (See the CLI Reference Guide).

29.2 Loop Guard Setup

Click **Advanced Application > Loop Guard** in the navigation panel to display the screen as shown.

Note: The loop guard feature cannot be enabled on the ports that have Spanning Tree Protocol (RSTP, MRSTP or MSTP) enabled.

Figure 195 Advanced Application > Loop Guard

Loop Guard	
Active	<input type="checkbox"/>
Port	Active
*	<input type="checkbox"/>
1	<input type="checkbox"/>
2	<input type="checkbox"/>
3	<input type="checkbox"/>
4	<input type="checkbox"/>
5	<input type="checkbox"/>
6	<input type="checkbox"/>
7	<input type="checkbox"/>
8	<input type="checkbox"/>
9	<input type="checkbox"/>
<input type="button" value="Apply"/> <input type="button" value="Cancel"/>	

The following table describes the labels in this screen.

Table 118 Advanced Application > Loop Guard

LABEL	DESCRIPTION
Active	Select this option to enable loop guard on the Switch. The Switch generates syslog, internal log messages as well as SNMP traps when it shuts down a port via the loop guard feature.
Port	This field displays the port number.
*	Settings in this row apply to all ports. Use this row only if you want to make some settings the same for all ports. Use this row first to set the common settings and then make adjustments on a port-by-port basis. Note: Changes in this row are copied to all the ports as soon as you make them.
Active	Select this check box to enable the loop guard feature on this port. The Switch sends broadcast and multicast probe packets from this port to check if the switch it is connected to is in loop state. If the switch that this port is connected is in loop state the Switch will shut down this port. Clear this check box to disable the loop guard feature.
Apply	Click Apply to save your changes to the Switch's run-time memory. The Switch loses these changes if it is turned off or loses power, so use the Save link on the top navigation panel to save your changes to the non-volatile memory when you are done configuring.
Cancel	Click Cancel to begin configuring this screen afresh.

CHAPTER 30

Layer 2 Protocol Tunneling

30.1 Layer 2 Protocol Tunneling Overview

This chapter shows you how to configure layer 2 protocol tunneling on the Switch.

30.1.1 What You Can Do

Use the **Layer 2 Protocol Tunnel** screen ([Section 30.2 on page 268](#)) to enable layer 2 protocol tunneling on the Switch and specify a MAC address with which the Switch uses to encapsulate the layer 2 protocol packets by replacing the destination MAC address in the packets.

30.1.2 What You Need to Know

Layer 2 protocol tunneling (L2PT) is used on the service provider's edge devices.

L2PT allows edge switches (**1** and **2** in the following figure) to tunnel layer 2 STP (Spanning Tree Protocol), CDP (Cisco Discovery Protocol) and VTP (VLAN Trunking Protocol) packets between customer switches (**A**, **B** and **C** in the following figure) connected through the service provider's network. The edge switch encapsulates layer 2 protocol packets with a specific MAC address before sending them across the service provider's network to other edge switches.

Figure 196 Layer 2 Protocol Tunneling Network Scenario

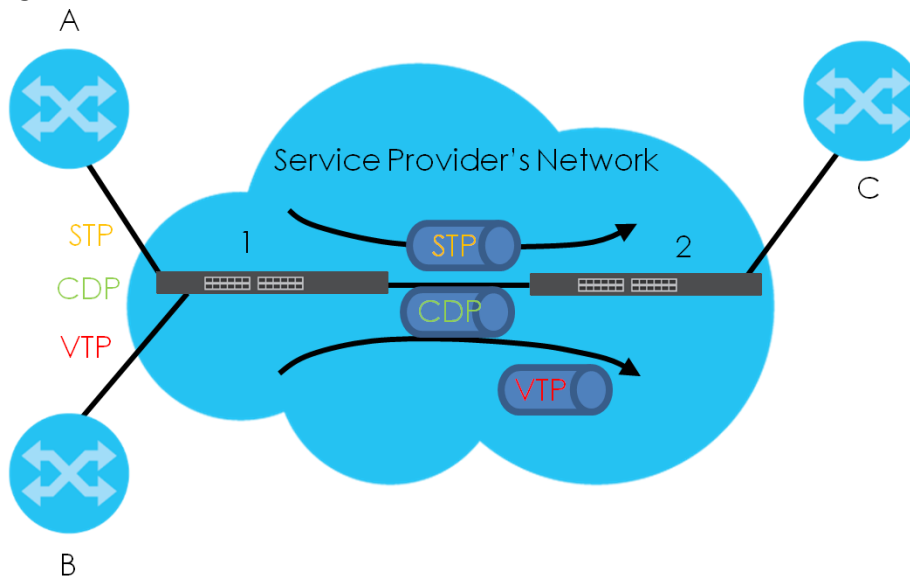

In the following example, if you enable L2PT for STP, you can have switches **A**, **B**, **C** and **D** in the same

spanning tree, even though switch **A** is not directly connected to switches **B**, **C** and **D**. Topology change information can be propagated throughout the service provider's network.

To emulate a point-to-point topology between two customer switches at different sites, such as **A** and **B**, you can enable protocol tunneling on edge switches **1** and **2** for PAgP (Port Aggregation Protocol), LACP or UDLD (Uni-Directional Link Detection).

Figure 197 L2PT Network Example

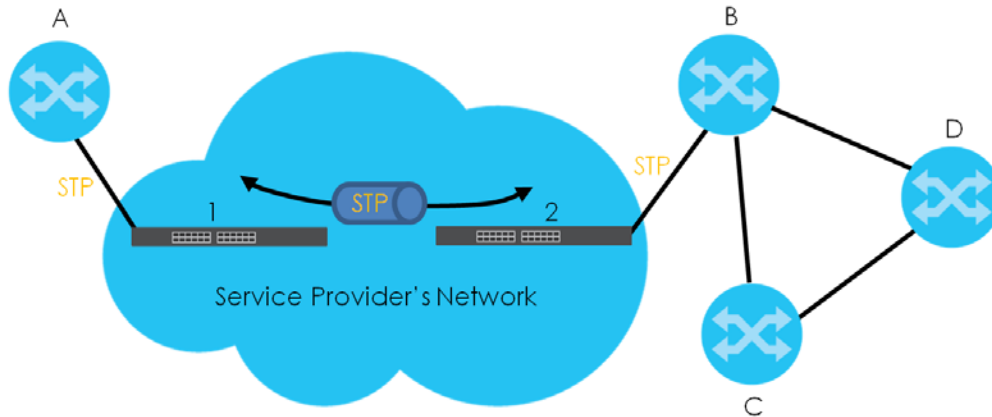

30.1.2.1 Layer 2 Protocol Tunneling Mode

Each port can have two layer 2 protocol tunneling modes, **Access** and **Tunnel**.

- The **Access** port is an ingress port on the service provider's edge device (1 or 2 in [Figure 197 on page 268](#)) and connected to a customer switch (**A** or **B**). Incoming layer 2 protocol packets received on an access port are encapsulated and forwarded to the tunnel ports.
- The **Tunnel** port is an egress port at the edge of the service provider's network and connected to another service provider's switch. Incoming encapsulated layer 2 protocol packets received on a tunnel port are decapsulated and sent to an access port.

30.2 Configuring Layer 2 Protocol Tunneling

Click **Advanced Application > Layer 2 Protocol Tunneling** in the navigation panel to display the screen as shown.

Figure 198 Advanced Application > Layer 2 Protocol Tunneling

Port	CDP	STP	VTP	PAGP	LACP	UDLD	Mode
*	<input type="checkbox"/>	<input type="checkbox"/>	<input type="checkbox"/>	<input type="checkbox"/>	<input type="checkbox"/>	<input type="checkbox"/>	Access ▾
1	<input type="checkbox"/>	<input type="checkbox"/>	<input type="checkbox"/>	<input type="checkbox"/>	<input type="checkbox"/>	<input type="checkbox"/>	Access ▾
2	<input type="checkbox"/>	<input type="checkbox"/>	<input type="checkbox"/>	<input type="checkbox"/>	<input type="checkbox"/>	<input type="checkbox"/>	Access ▾
3	<input type="checkbox"/>	<input type="checkbox"/>	<input type="checkbox"/>	<input type="checkbox"/>	<input type="checkbox"/>	<input type="checkbox"/>	Access ▾
4	<input type="checkbox"/>	<input type="checkbox"/>	<input type="checkbox"/>	<input type="checkbox"/>	<input type="checkbox"/>	<input type="checkbox"/>	Access ▾
5	<input type="checkbox"/>	<input type="checkbox"/>	<input type="checkbox"/>	<input type="checkbox"/>	<input type="checkbox"/>	<input type="checkbox"/>	Access ▾
6	<input type="checkbox"/>	<input type="checkbox"/>	<input type="checkbox"/>	<input type="checkbox"/>	<input type="checkbox"/>	<input type="checkbox"/>	Access ▾
7	<input type="checkbox"/>	<input type="checkbox"/>	<input type="checkbox"/>	<input type="checkbox"/>	<input type="checkbox"/>	<input type="checkbox"/>	Access ▾
8	<input type="checkbox"/>	<input type="checkbox"/>	<input type="checkbox"/>	<input type="checkbox"/>	<input type="checkbox"/>	<input type="checkbox"/>	Access ▾
9	<input type="checkbox"/>	<input type="checkbox"/>	<input type="checkbox"/>	<input type="checkbox"/>	<input type="checkbox"/>	<input type="checkbox"/>	Access ▾

The following table describes the labels in this screen.

Table 119 Advanced Application > Layer 2 Protocol Tunneling

LABEL	DESCRIPTION
Active	Select this to enable layer 2 protocol tunneling on the Switch.
Destination MAC Address	Specify a MAC address with which the Switch uses to encapsulate the layer 2 protocol packets by replacing the destination MAC address in the packets. Note: The MAC address can be either a unicast MAC address or multicast MAC address. If you use a unicast MAC address, make sure the MAC address does not exist in the address table of a switch on the service provider's network. Note: All the edge switches in the service provider's network should be set to use the same MAC address for encapsulation.
Port	This field displays the port number. * means all ports.
*	Use this row to make the setting the same for all ports. Use this row first and then make adjustments on a port-by-port basis. Note: Changes in this row are copied to all the ports as soon as you make them.
CDP	Select this option to have the Switch tunnel CDP (Cisco Discovery Protocol) packets so that other Cisco devices can be discovered through the service provider's network.
STP	Select this option to have the Switch tunnel STP (Spanning Tree Protocol) packets so that STP can run properly across the service provider's network and spanning trees can be set up based on bridge information from all (local and remote) networks.
VTP	Select this option to have the Switch tunnel VTP (VLAN Trunking Protocol) packets so that all customer switches can use consistent VLAN configuration through the service provider's network.

Table 119 Advanced Application > Layer 2 Protocol Tunneling (continued)

LABEL	DESCRIPTION
Point to Point	<p>The Switch supports PAGP (Port Aggregation Protocol), LACP (Link Aggregation Control Protocol) and UDLD (UniDirectional Link Detection) tunneling for a point-to-point topology.</p> <p>Both PAGP and UDLD are Cisco's proprietary data link layer protocols. PAGP is similar to LACP and used to set up a logical aggregation of Ethernet ports automatically. UDLD is to determine the link's physical status and detect a unidirectional link.</p>
PAGP	Select this option to have the Switch send PAGP packets to a peer to automatically negotiate and build a logical port aggregation.
LACP	Select this option to have the Switch send LACP packets to a peer to dynamically creates and manages trunk groups.
UDLD	Select this option to have the Switch send UDLD packets to a peer's port it connected to monitor the physical status of a link.
Mode	<p>Select Access to have the Switch encapsulate the incoming layer 2 protocol packets and forward them to the tunnel ports. Select Access for ingress ports at the edge of the service provider's network.</p> <p>Note: You can enable L2PT services for STP, LACP, VTP, CDP, UDLD, and PAGP on the access ports only.</p> <p>Select Tunnel for egress ports at the edge of the service provider's network. The Switch decapsulates the encapsulated layer 2 protocol packets received on a tunnel port by changing the destination MAC address to the original one, and then forward them to an access port. If the services is not enabled on an access port, the protocol packets are dropped.</p>
Apply	Click Apply to save your changes to the Switch's run-time memory. The Switch loses these changes if it is turned off or loses power, so use the Save link on the top navigation panel to save your changes to the non-volatile memory when you are done configuring.
Cancel	Click Cancel to begin configuring this screen afresh.

CHAPTER 31

PPPoE

31.1 PPPoE Intermediate Agent Overview

This chapter describes how the Switch gives a PPPoE termination server additional information that the server can use to identify and authenticate a PPPoE client.

A PPPoE Intermediate Agent (PPPoE IA) is deployed between a PPPoE server and PPPoE clients. It helps the PPPoE server identify and authenticate clients by adding subscriber line specific information to PPPoE discovery packets from clients on a per-port or per-port-per-VLAN basis before forwarding them to the PPPoE server.

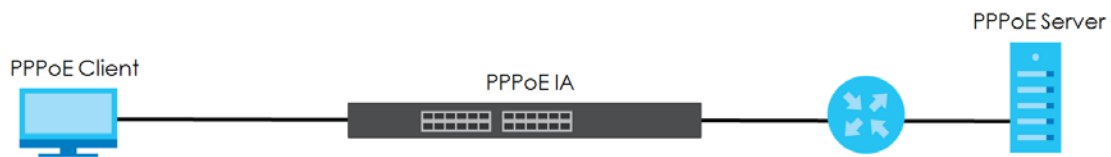

31.1.1 What You Can Do

- Use the **PPPoE** screen ([Section 31.2 on page 273](#)) to display the main PPPoE screen.
- Use the **Intermediate Agent** screen ([Section 31.3 on page 274](#)) to enable the PPPoE Intermediate Agent on the Switch.
- Use the **PPPoE IA Per-Port** screen ([Section 31.3.1 on page 275](#)) to set the port state and configure PPPoE intermediate agent sub-options on a per-port basis.
- Use the **PPPoE IA Per-Port Per-VLAN** screen ([Section 31.3.2 on page 276](#)) to configure PPPoE IA settings that apply to a specific VLAN on a port.
- Use the **PPPoE IA for VLAN** ([Section 31.3.3 on page 277](#)) to enable the PPPoE Intermediate Agent on a VLAN.

31.1.2 What You Need to Know

Read on for concepts on ARP that can help you configure the screen in this chapter.

31.1.2.1 PPPoE Intermediate Agent Tag Format

If the PPPoE Intermediate Agent is enabled, the Switch adds a vendor-specific tag to PADI (PPPoE Active Discovery Initialization) and PADR (PPPoE Active Discovery Request) packets from PPPoE clients.

This tag is defined in RFC 2516 and has the following format for this feature.

Table 120 PPPoE Intermediate Agent Vendor-specific Tag Format

Tag_Type (0x0105)	Tag_Len	Value	i1	i2
----------------------	---------	-------	----	----

The Tag_Type is 0x0105 for vendor-specific tags, as defined in RFC 2516. The Tag_Len indicates the length of Value, i1 and i2. The Value is the 32-bit number 0x00000DE9, which stands for the "ADSL Forum" IANA entry. i1 and i2 are PPPoE intermediate agent sub-options, which contain additional information about the PPPoE client.

31.1.2.2 Sub-Option Format

There are two types of sub-option: "Agent Circuit ID Sub-option" and "Agent Remote ID Sub-option". They have the following formats.

Table 121 PPPoE IA Circuit ID Sub-option Format: User-defined String

SubOpt	Length	Value
0x01 (1 byte)	N (1 byte)	String (63 bytes)

Table 122 PPPoE IA Remote ID Sub-option Format

SubOpt	Length	Value
0x02 (1 byte)	N (1 byte)	MAC Address or String (63 bytes)

The 1 in the first field identifies this as an Agent Circuit ID sub-option and 2 identifies this as an Agent Remote ID sub-option. The next field specifies the length of the field. The Switch takes the Circuit ID string you manually configure for a VLAN on a port as the highest priority and the Circuit ID string for a port as the second priority. In addition, the Switch puts the PPPoE client's MAC address into the Agent Remote ID Sub-option if you do not specify any user-defined string.

Flexible Circuit ID Syntax with Identifier String and Variables

If you do not configure a Circuit ID string for a VLAN on a specific port or for a specific port, the Switch adds the user-defined identifier string and variables into the Agent Circuit ID Sub-option. The variables can be the slot ID of the PPPoE client, the port number of the PPPoE client and/or the VLAN ID on the PPPoE packet.

The identifier-string, slot ID, port number and VLAN ID are separated from each other by a pound key (#), semi-colon (;), period (.), comma (,), forward slash (/) or space. An Agent Circuit ID Sub-option example is "Switch/07/0123" and indicates the PPPoE packets come from a PPPoE client which is connected to the Switch's port 7 and belong to VLAN 123.

Table 123 PPPoE IA Circuit ID Sub-option Format: Using Identifier String and Variables

SubOpt	Length	Value						
0x01 (1 byte)	N (1 byte)	Identifier String (53 bytes)	delimiter (1 byte)	Slot ID (1 byte)	delimiter (1 byte)	Port No (2 bytes)	delimiter (1 byte)	VLAN ID (4 bytes)

WT-101 Default Circuit ID Syntax

If you do not configure a Circuit ID string for a specific VLAN on a port or for a specific port, and disable the flexible Circuit ID syntax in the **PPPoE > Intermediate Agent** screen, the Switch automatically generates a Circuit ID string according to the default Circuit ID syntax which is defined in the DSL Forum Working Text (WT)-101. The default access node identifier is the host name of the PPPoE intermediate agent and the eth indicates "Ethernet".

Table 124 PPPoE IA Circuit ID Sub-option Format: Defined in WT-101

SubOpt	Length	Value									
0x01 (1 byte)	N (1 byte)	Access Node Identifier (20 byte)	Space (1 byte)	eth (3 byte)	Space (1 byte)	Slot ID (1 byte)	/ (1 byte)	Port No (2 byte)	:	(1 byte)	VLAN ID (4 bytes)

31.1.2.3 Port State

Every port is either a trusted port or an untrusted port for the PPPoE intermediate agent. This setting is independent of the trusted or untrusted setting for DHCP snooping or ARP inspection. You can also specify the agent sub-options (circuit ID and remote ID) that the Switch adds to PADI and PADR packets from PPPoE clients.

Trusted ports are connected to PPPoE servers.

- If a PADO (PPPoE Active Discovery Offer), PADS (PPPoE Active Discovery Session-confirmation), or PADT (PPPoE Active Discovery Terminate) packet is sent from a PPPoE server and received on a trusted port, the Switch forwards it to all other ports.
- If a PADI or PADR packet is sent from a PPPoE client but received on a trusted port, the Switch forwards it to other trusted ports.

Note: The Switch will drop all PPPoE discovery packets if you enable the PPPoE intermediate agent and there are no trusted ports.

Untrusted ports are connected to subscribers.

- If a PADI, PADR, or PADT packet is sent from a PPPoE client and received on an untrusted port, the Switch adds a vendor-specific tag to the packet and then forwards it to the trusted ports.
- The Switch discards PADO and PADS packets which are sent from a PPPoE server but received on an untrusted port.

31.2 PPPoE

Use this screen to configure the PPPoE Intermediate Agent on the Switch.

Click **Advanced Application > PPPoE** in the navigation panel to display the screen as shown. Click **Click Here** to go to the **Intermediate Agent** screen.

Figure 199 Advanced Application > PPPoE > Intermediate Agent



31.3 PPPoE Intermediate Agent

Use this screen to configure the Switch to give a PPPoE termination server additional subscriber information that the server can use to identify and authenticate a PPPoE client.

Click **Advanced Application > PPPoE > Intermediate Agent** in the navigation panel to display the screen as shown.

Figure 200 Advanced Application > PPPoE > Intermediate Agent

The following table describes the labels in this screen.

Table 125 Advanced Application > PPPoE > Intermediate Agent

LABEL	DESCRIPTION
Active	Select this option to enable the PPPoE intermediate agent globally on the Switch.
access-node-identifier	Enter up to 20 ASCII characters to identify the PPPoE intermediate agent. Hyphens (-) and spaces are also allowed. The default is the Switch's host name.
circuit-id	Use this section to configure the Circuit ID field in the PADI and PADR packets. The Circuit ID you configure for a specific port or for a specific VLAN on a port has priority over this. The Circuit ID you configure for a specific port (in the Advanced Application > PPPoE > Intermediate Agent > Port screen) or for a specific VLAN on a port (in the Advanced Application > PPPoE > Intermediate Agent > Port > VLAN screen) has priority over this. That means, if you also want to configure PPPoE IA Per-Port or Per-Port Per-VLAN setting, leave the fields here empty and configure circuit-id and remote-id in the Per-Port or Per-Port Per-VLAN screen.
Active	Select this option to have the Switch add the user-defined identifier string and variables (specified in the option field) to PADI or PADR packets from PPPoE clients. If you leave this option unselected and do not configure any Circuit ID string (using CLI commands) on the Switch, the Switch will use the string specified in the access-node-identifier field.
identifier-string	Specify a string that the Switch adds in the Agent Circuit ID sub-option. You can enter up to 53 ASCII characters. Spaces are allowed.
option	Select the variables that you want the Switch to generate and add in the Agent Circuit ID sub-option. The variable options include sp , sv , pv and spv which indicate combinations of slot-port, slot-VLAN, port-VLAN and slot-port-VLAN respectively. The Switch enters a zero into the PADI and PADR packets for the slot value.
delimiter	Select a delimiter to separate the identifier-string, slot ID, port number and/or VLAN ID from each other. You can use a pound key (#), semi-colon (;), period (.), comma (,), forward slash (/) or space.

Table 125 Advanced Application > PPPoE > Intermediate Agent (continued)

LABEL	DESCRIPTION
Apply	Click Apply to save your changes to the Switch's run-time memory. The Switch loses these changes if it is turned off or loses power, so use the Save link on the top navigation panel to save your changes to the non-volatile memory when you are done configuring.
Cancel	Click Cancel to begin configuring this screen afresh.

31.3.1 PPPoE IA Per-Port

Use this screen to specify whether individual ports are trusted or untrusted ports and have the Switch add extra information to PPPoE discovery packets from PPPoE clients on a per-port basis.

Note: The Switch will drop all PPPoE packets if you enable the PPPoE Intermediate Agent on the Switch and there are no trusted ports.

Click the **Port** link in the **Intermediate Agent** screen to display the screen as shown.

Figure 201 Advanced Application > PPPoE > Intermediate Agent > Port

Port	Server Trusted State	Circuit-id	Remote-id
*	Untrusted ▾		
1	Untrusted ▾		
2	Untrusted ▾		
3	Untrusted ▾		
4	Untrusted ▾		
5	Untrusted ▾		
6	Untrusted ▾		
7	Untrusted ▾		
8	Untrusted ▾		
9	Untrusted ▾		

Apply Cancel

The following table describes the labels in this screen.

Table 126 Advanced Application > PPPoE > Intermediate Agent > Port

LABEL	DESCRIPTION
Port	This field displays the port number. * means all ports.
*	Use this row to make the setting the same for all ports. Use this row first and then make adjustments on a port-by-port basis. Changes in this row are copied to all the ports as soon as you make them.

Table 126 Advanced Application > PPPoE > Intermediate Agent > Port (continued)

LABEL	DESCRIPTION
Server Trusted State	<p>Select whether this port is a trusted port (Trusted) or an untrusted port (Untrusted).</p> <p>Trusted ports are uplink ports connected to PPPoE servers.</p> <p>If a PADO (PPPoE Active Discovery Offer), PADS (PPPoE Active Discovery Session-confirmation), or PADT (PPPoE Active Discovery Terminate) packet is sent from a PPPoE server and received on a trusted port, the Switch forwards it to all other ports.</p> <p>If a PADI or PADR packet is sent from a PPPoE client but received on a trusted port, the Switch forwards it to other trusted ports.</p> <p>Untrusted ports are downlink ports connected to subscribers.</p> <p>If a PADI, PADR, or PADT packet is sent from a PPPoE client and received on an untrusted port, the Switch adds a vendor-specific tag to the packet and then forwards it to the trusted ports.</p> <p>The Switch discards PADO and PADS packets which are sent from a PPPoE server but received on an untrusted port.</p>
Circuit-id	<p>Enter a string of up to 63 ASCII characters that the Switch adds into the Agent Circuit ID sub-option for PPPoE discovery packets received on this port. Spaces are allowed.</p> <p>The Circuit ID you configure for a specific VLAN on a port (in the Advanced Application > PPPoE > Intermediate Agent > Port > VLAN screen) has the highest priority.</p>
Remote-id	<p>Enter a string of up to 63 ASCII characters that the Switch adds into the Agent Remote ID sub-option for PPPoE discovery packets received on this port. Spaces are allowed.</p> <p>If you do not specify a string here or in the Remote-id field for a VLAN on a port, the Switch automatically uses the PPPoE client's MAC address.</p> <p>The Remote ID you configure for a specific VLAN on a port (in the Advanced Application > PPPoE > Intermediate Agent > Port > VLAN screen) has the highest priority.</p>
Apply	Click Apply to save your changes to the Switch's run-time memory. The Switch loses these changes if it is turned off or loses power, so use the Save link on the top navigation panel to save your changes to the non-volatile memory when you are done configuring.
Cancel	Click Cancel to begin configuring this screen afresh.

31.3.2 PPPoE IA Per-Port Per-VLAN

Use this screen to configure PPPoE IA settings that apply to a specific VLAN on a port.

Click the **VLAN** link in the **Intermediate Agent > Port** screen to display the screen as shown.

Figure 202 Advanced Application > PPPoE > Intermediate Agent > Port > VLAN

The following table describes the labels in this screen.

Table 127 Advanced Application > PPPoE > Intermediate Agent > Port > VLAN

LABEL	DESCRIPTION
Show Port	Enter a port number to show the PPPoE Intermediate Agent settings for the specified VLAN(s) on the port.
Show VLAN	Use this section to specify the VLANs you want to configure in the section below.
Start VID	Enter the lowest VLAN ID you want to configure in the section below.
End VID	Enter the highest VLAN ID you want to configure in the section below.
Apply	Click Apply to display the specified range of VLANs in the section below.
Port	This field displays the port number specified above.
VID	This field displays the VLAN ID of each VLAN in the range specified above. If you configure the * VLAN, the settings are applied to all VLANs.
*	Use this row to make the setting the same for all VLANs. Use this row first and then make adjustments on a VLAN-by-VLAN basis. Changes in this row are copied to all the VLANs as soon as you make them.
Circuit-id	Enter a string of up to 63 ASCII characters that the Switch adds into the Agent Circuit ID sub-option for this VLAN on the specified port. Spaces are allowed. The Circuit ID you configure here has the highest priority.
Remote-id	Enter a string of up to 63 ASCII characters that the Switch adds into the Agent Remote ID sub-option for this VLAN on the specified port. Spaces are allowed. If you do not specify a string here or in the Remote-id field for a specific port, the Switch automatically uses the PPPoE client's MAC address. The Remote ID you configure here has the highest priority.
Apply	Click Apply to save your changes to the Switch's run-time memory. The Switch loses these changes if it is turned off or loses power, so use the Save link on the top navigation panel to save your changes to the non-volatile memory when you are done configuring.
Cancel	Click Cancel to begin configuring this screen afresh.

31.3.3 PPPoE IA for VLAN

Use this screen to set whether the PPPoE Intermediate Agent is enabled on a VLAN and whether the Switch appends the Circuit ID and/or Remote ID to PPPoE discovery packets from a specific VLAN.

Click the **VLAN** link in the **Intermediate Agent** screen to display the screen as shown.

Figure 203 Advanced Application > PPPoE > Intermediate Agent > VLAN

The screenshot shows the 'VLAN' configuration page. At the top, there is a 'Show VLAN' section with 'Start VID' and 'End VID' input fields, and an 'Apply' button. Below this is a table with the following columns: 'VID', 'Enabled', 'Circuit-id', and 'Remote-id'. The 'VID' column contains a '*' entry. The 'Enabled' column has a dropdown menu set to 'No'. The 'Circuit-id' and 'Remote-id' columns have empty input fields. At the bottom of the screen, there are 'Apply' and 'Cancel' buttons.

The following table describes the labels in this screen.

Table 128 Advanced Application > PPPoE > Intermediate Agent > VLAN

LABEL	DESCRIPTION
Show VLAN	Use this section to specify the VLANs you want to configure in the section below.
Start VID	Enter the lowest VLAN ID you want to configure in the section below.
End VID	Enter the highest VLAN ID you want to configure in the section below.
Apply	Click Apply to display the specified range of VLANs in the section below.
VID	This field displays the VLAN ID of each VLAN in the range specified above. If you configure the * VLAN, the settings are applied to all VLANs.
*	Use this row to make the setting the same for all VLANs. Use this row first and then make adjustments on a VLAN-by-VLAN basis. Changes in this row are copied to all the VLANs as soon as you make them.
Enabled	Select this option to turn on the PPPoE Intermediate Agent on a VLAN.
Circuit-id	Select this option to make the Circuit ID settings for a specific VLAN take effect.
Remote-id	Select this option to make the Remote ID settings for a specific VLAN take effect.
Apply	Click Apply to save your changes to the Switch's run-time memory. The Switch loses these changes if it is turned off or loses power, so use the Save link on the top navigation panel to save your changes to the non-volatile memory when you are done configuring.
Cancel	Click Cancel to begin configuring this screen afresh.

CHAPTER 32

Error Disable

32.1 Error Disable Overview

This chapter shows you how to configure the rate limit for control packets on a port, and set the Switch to take an action (such as to shut down a port or stop sending packets) on a port when the Switch detects a pre-configured error. It also shows you how to configure the Switch to automatically undo the action after the error is gone.

32.1.1 CPU Protection Overview

Switches exchange protocol control packets in a network to get the latest networking information. If a switch receives large numbers of control packets, such as ARP, BPDU or IGMP packets, which are to be processed by the CPU, the CPU may become overloaded and be unable to handle regular tasks properly.

The CPU protection feature allows you to limit the rate of ARP, BPDU and IGMP packets to be delivered to the CPU on a port. This enhances the CPU efficiency and protects against potential DoS attacks or errors from other networks. You then can choose to drop control packets that exceed the specified rate limit or disable a port on which the packets are received.

32.1.2 Error-Disable Recovery Overview

Some features, such as loop guard or CPU protection, allow the Switch to shut down a port or discard specific packets on a port when an error is detected on the port. For example, if the Switch detects that packets sent out the ports loop back to the Switch, the Switch can shut down the ports automatically. After that, you need to enable the ports or allow the packets on a port manually via the Web Configurator or the commands. With error-disable recovery, you can set the disabled ports to become active or start receiving the packets again after the time interval you specify.

32.1.3 What You Can Do

- Use the **Errdisable Status** screen ([Section 32.3 on page 280](#)) to view whether the Switch detected that control packets exceeded the rate limit configured for a port or a port is disabled according to the feature requirements and what action you configure, and related information.
- Use the **CPU Protection** screen ([Section 32.4 on page 282](#)) to limit the maximum number of control packets (ARP, BPDU and/or IGMP) that the Switch can receive or transmit on a port.
- Use the **Errdisable Detect** screen ([Section 32.5 on page 283](#)) to have the Switch detect whether the control packets exceed the rate limit configured for a port and configure the action to take once the limit is exceeded.
- Use the **Errdisable Recovery** screen ([Section 32.6 on page 284](#)) to set the Switch to automatically undo an action after the error is gone.

32.2 Error Disable Settings

Use this screen to go to the screens where you can configure error disable related settings. Click **Advanced Application > Errdisable** in the navigation panel to open the following screen.

Figure 204 Advanced Application > Errdisable



Errdisable	
Errdisable Status	Click here
CPU protection	Click here
Errdisable Detect	Click here
Errdisable Recovery	Click here

The following table describes the labels in this screen.

Table 129 Advanced Application > Errdisable

LABEL	DESCRIPTION
Errdisable Status	Click this link to view whether the Switch detected that control packets exceeded the rate limit configured for a port or a port is disabled according to the feature requirements and what action you configure, and related information.
CPU protection	Click this link to limit the maximum number of control packets (ARP, BPDU and/or IGMP) that the Switch can receive or transmit on a port.
Errdisable Detect	Click this link to have the Switch detect whether the control packets exceed the rate limit configured for a port and configure the action to take once the limit is exceeded.
Errdisable Recovery	Click this link to set the Switch to automatically undo an action after the error is gone.

32.3 Error-Disable Status

Use this screen to view whether the Switch detected that control packets exceeded the rate limit configured for a port or a port is disabled according to the feature requirements and what action you configure, and related information. Click the **Click here** link next to **Errdisable Status** in the **Advanced Application > Errdisable** screen to display the screen as shown.

Figure 205 Advanced Application > Errdisable > Errdisable Status

Errdisable Status							
Inactive-reason mode reset							
Port List				Cause		ARP	Reset
Errdisable Status							
Port	Cause	Active	Mode	Rate	Status	Recovery Time Left (secs)	Total Dropped
1	Loop Guard	NO	inactive-port	-	Forwarding	-	-
	ARP	NO	inactive-port	0	Forwarding	-	-
	BPDU	NO	inactive-port	0	Forwarding	-	-
	IGMP	NO	inactive-port	0	Forwarding	-	-
2	Loop Guard	NO	inactive-port	-	Forwarding	-	-
	ARP	NO	inactive-port	0	Forwarding	-	-
	BPDU	NO	inactive-port	0	Forwarding	-	-
	IGMP	NO	inactive-port	0	Forwarding	-	-
3	Loop Guard	NO	inactive-port	-	Forwarding	-	-
	ARP	NO	inactive-port	0	Forwarding	-	-
	BPDU	NO	inactive-port	0	Forwarding	-	-
	IGMP	NO	inactive-port	0	Forwarding	-	-
4	Loop Guard	NO	inactive-port	-	Forwarding	-	-
	ARP	NO	inactive-port	0	Forwarding	-	-
	BPDU	NO	inactive-port	0	Forwarding	-	-
	IGMP	NO	inactive-port	0	Forwarding	-	-
5	Loop Guard	NO	inactive-port	-	Forwarding	-	-
	ARP	NO	inactive-port	0	Forwarding	-	-
	BPDU	NO	inactive-port	0	Forwarding	-	-
	IGMP	NO	inactive-port	0	Forwarding	-	-
	Loop Guard	NO	inactive-port	-	Forwarding	-	-
	ARP	NO	inactive-port	0	Forwarding	-	-
	BPDU	NO	inactive-port	0	Forwarding	-	-
	IGMP	NO	inactive-port	0	Forwarding	-	-

The following table describes the labels in this screen.

Table 130 Advanced Application > Errdisable > Errdisable Status

LABEL	DESCRIPTION
Inactive-reason mode reset	
Port List	Enter the number of the ports (separated by a comma) on which you want to reset inactive-reason status.
Cause	Select the cause of inactive-reason mode you want to reset here.
Reset	Press to reset the specified ports to handle ARP, BPDU or IGMP packets instead of ignoring them, if the ports is in inactive-reason mode.
Errdisable Status	
Port	This is the number of the port on which you want to configure Errdisable Status.
Cause	This displays the type of the control packet received on the port or the feature enabled on the port and causing the Switch to take the specified action.
Active	This field displays whether the control packets (ARP, BPDU, and/or IGMP) on the port is being detected or not. It also shows whether loop guard is enabled on the port.

Table 130 Advanced Application > Errdisable > Errdisable Status (continued)

LABEL	DESCRIPTION
Mode	This field shows the action that the Switch takes for the cause. <ul style="list-style-type: none"> inactive-port – The Switch disables the port. inactive-reason – The Switch drops all the specified control packets (such as BPDU) on the port. rate-limitation – The Switch drops the additional control packets the ports has to handle in every one second.
Rate	This field displays how many control packets this port can receive or transmit per second. It can be adjusted in CPU Protection . 0 means no rate limit.
Status	This field displays the errdisable status <ul style="list-style-type: none"> Forwarding: The Switch is forwarding packets. Rate-limitation mode is always in Forwarding status. Err-disable: The Switch disables the port on which the control packets are received (inactive-port) or drops specified control packets on the port (inactive-reason).
Recovery Time Left (secs)	This field displays the time (seconds) left before the ports becomes active of Errdisable Recovery.
Total Dropped	This field displays the total packet number dropped by this port where the packet rate exceeds the rate of mode rate-limitation.

32.4 CPU Protection Configuration

Use this screen to limit the maximum number of control packets (ARP, BPDU and/or IGMP) that the Switch can receive or transmit on a port. Click the **Click Here** link next to **CPU protection** in the **Advanced Application > Errdisable** screen to display the screen as shown.

Note: After you configure this screen, make sure you also enable error detection for the specific control packets in the **Advanced Application > Errdisable > Errdisable Detect** screen.

Figure 206 Advanced Application > Errdisable > CPU protection

Port	Rate Limit (pkt/s)
*	0
1	0
2	0
3	0
4	0
5	0
6	0
7	0
8	0
9	0

The following table describes the labels in this screen.

Table 131 Advanced Application > Errdisable > CPU protection

LABEL	DESCRIPTION
Reason	Select the type of control packet you want to configure here.
Port	This field displays the port number.
*	Use this row to make the setting the same for all ports. Use this row first and then make adjustments to each port if necessary. Changes in this row are copied to all the ports as soon as you make them.
Rate Limit (pkt/s)	Enter a number from 0 to 256 to specify how many control packets this port can receive or transmit per second. 0 means no rate limit. You can configure the action that the Switch takes when the limit is exceeded.
Apply	Click Apply to save your changes to the Switch's run-time memory. The Switch loses these changes if it is turned off or loses power, so use the Save link on the top navigation panel to save your changes to the non-volatile memory when you are done configuring.
Cancel	Click Cancel to begin configuring this screen afresh.

32.5 Error-Disable Detect Configuration

Use this screen to have the Switch detect whether the control packets exceed the rate limit configured for a port and configure the action to take once the limit is exceeded. Click the **Click Here** link next to **Errdisable Detect** link in the **Advanced Application > Errdisable** screen to display the screen as shown.

Figure 207 Advanced Application > Errdisable > Errdisable Detect

Cause	Active	Mode
*	<input type="checkbox"/>	inactive-port ▼
ARP	<input type="checkbox"/>	inactive-port ▼
BPDU	<input type="checkbox"/>	inactive-port ▼
IGMP	<input type="checkbox"/>	inactive-port ▼

The following table describes the labels in this screen.

Table 132 Advanced Application > Errdisable > Errdisable Detect

LABEL	DESCRIPTION
Cause	This field displays the types of control packet that may cause CPU overload.
*	Use this row to make the setting the same for all entries. Use this row first and then make adjustments to each entry if necessary. Changes in this row are copied to all the entries as soon as you make them.
Active	Select this option to have the Switch detect if the configured rate limit for a specific control packet is exceeded and take the action selected below.

Table 132 Advanced Application > Errdisable > Errdisable Detect (continued)

LABEL	DESCRIPTION
Mode	Select the action that the Switch takes when the number of control packets exceed the rate limit on a port, set in the Advanced Application > Errdisable > CPU protection screen. <ul style="list-style-type: none"> inactive-port – The Switch disables the port on which the control packets are received. inactive-reason – The Switch drops all the specified control packets (such as BPDU) on the port. rate-limitation – The Switch drops the additional control packets the ports has to handle in every one second.
Apply	Click Apply to save your changes to the Switch's run-time memory. The Switch loses these changes if it is turned off or loses power, so use the Save link on the top navigation panel to save your changes to the non-volatile memory when you are done configuring.
Cancel	Click Cancel to begin configuring this screen afresh.

32.6 Error-Disable Recovery Configuration

Use this screen to configure the Switch to automatically undo an action after the error is gone. Click the **Click Here** link next to **Errdisable Recovery** in the **Advanced Application > Errdisable** screen to display the screen as shown.

Figure 208 Advanced Application > Errdisable > Errdisable Recovery

Reason	Timer Status	Interval
*	<input type="checkbox"/>	
loopguard	<input type="checkbox"/>	300
ARP	<input type="checkbox"/>	300
BPDU	<input type="checkbox"/>	300
IGMP	<input type="checkbox"/>	300

The following table describes the labels in this screen.

Table 133 Advanced Application > Errdisable > Errdisable Recovery

LABEL	DESCRIPTION
Active	Select this option to turn on the error-disable recovery function on the Switch.
Reason	This field displays the supported features that allow the Switch to shut down a port or discard packets on a port according to the feature requirements and what action you configure.
*	Use this row to make the setting the same for all entries. Use this row first and then make adjustments to each entry if necessary. Changes in this row are copied to all the entries as soon as you make them.
Timer Status	Select this check box to allow the Switch to wait for the specified time interval to activate a port or allow specific packets on a port, after the error was gone. Clear the check box to turn off this rule.

Table 133 Advanced Application > Errdisable > Errdisable Recovery (continued)

LABEL	DESCRIPTION
Interval	Enter the number of seconds (from 30 to 2592000) for the time interval.
Apply	Click Apply to save your changes to the Switch's run-time memory. The Switch loses these changes if it is turned off or loses power, so use the Save link on the top navigation panel to save your changes to the non-volatile memory when you are done configuring.
Cancel	Click Cancel to begin configuring this screen afresh.

CHAPTER 33

VLAN Isolation

This chapter shows you how to configure the Switch to prevent communications between ports in a VLAN.

33.1 VLAN Isolation Overview

Vlan Isolation allows you to do port isolation within a VLAN in a simple way. You specify which ports in a VLAN is not isolated by adding it to the promiscuous port list. The Switch automatically adds other ports in this VLAN to the isolated port list and blocks traffic between the isolated ports. A promiscuous port can communicate with any port in the same VLAN. An isolated port can communicate with the promiscuous ports only.

Note: You can have up to one VLAN Isolation rule for each VLAN.

Figure 209 VLAN Isolation Example

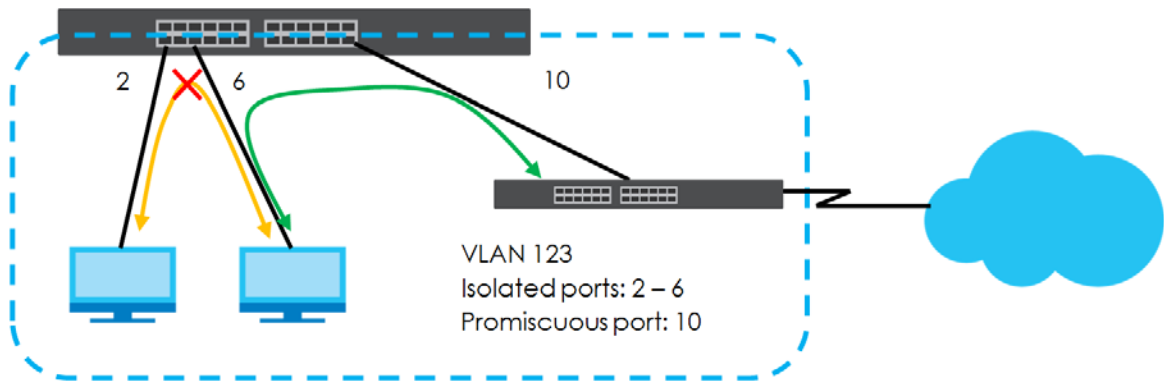

Note: Make sure you keep at least one port in the promiscuous port list for a VLAN with VLAN Isolation enabled. Otherwise, this VLAN is blocked from the whole network.

33.2 Configuring VLAN Isolation

Click **Advanced Application > Vlan Isolation** in the navigation panel to display the screen as shown.

Figure 210 Advanced Application > VLAN Isolation

The following table describes the labels in this screen.

Table 134 Advanced Application > VLAN Isolation

LABEL	DESCRIPTION
Active	Check this box to enable VLAN Isolation in a VLAN.
Name	Enter a descriptive name (up to 32 printable ASCII characters) for identification purposes.
VLAN ID	Enter a VLAN ID from 1 to 4094. This is the VLAN to which this rule applies.
Promiscuous Ports	Enter the number of the ports that can communicate with any ports in the same VLAN. Other ports belonging to this VLAN will be added to the isolation list and can only send and receive traffic from the ports you specify here.
Add	Click Add to insert the entry in the summary table below and save your changes to the Switch's run-time memory. The Switch loses these changes if it is turned off or loses power, so use the Save link on the top navigation panel to save your changes to the non-volatile memory when you are done configuring.
Cancel	Click Cancel to reset the fields to your previous configuration.
Clear	Click Clear to clear the fields to the factory defaults.
Index	This is the index number of the rule.
Active	This shows whether this rule is activated or not.
Name	This is the descriptive name for this rule.
VLAN	This is the VLAN to which this rule is applied.
Promiscuous Ports	This shows the ports that can communicate with any ports in the same VLAN.
	Select an entry's check box to select a specific entry. Otherwise, select the check box in the table heading row to select all entries.
Delete	Check the rules that you want to remove and then click the Delete button.
Cancel	Click Cancel to clear the check boxes.

CHAPTER 34

Green Ethernet

This chapter shows you how to configure the Switch to reduce the power consumed by switch ports.

34.1 Green Ethernet Overview

Green Ethernet reduces switch port power consumption in the following ways.

IEEE 802.3az Energy Efficient Ethernet (EEE)

If EEE is enabled, both sides of a link support EEE and there is no traffic, the port enters Low Power Idle (LPI) mode. LPI mode turns off some functions of the physical layer (becomes quiet) to save power. Periodically the port transmits a REFRESH signal to allow the link partner to keep the link alive. When there is traffic to be sent, a WAKE signal is sent to the link partner to return the link to active mode.

Auto Power Down

Auto Power Down turns off almost all functions of the port's physical layer functions when the link is down, so the port only uses power to check for a link up pulse from the link partner. After the link up pulse is detected, the port wakes up from **Auto Power Down** and operates normally.

Short Reach

Traditional Ethernet transmits all data with enough power to reach the maximum cable length. Shorter cables lose less power, so **Short Reach** saves power by adjusting the transmit power of each port according to the length of cable attached to that port.

34.2 Configuring Green Ethernet

Click **Advanced Application > Green Ethernet** in the navigation panel to display the screen as shown.

Note: EEE, Auto Power Down and Short Reach are NOT supported on an uplink port.

Figure 211 Advanced Application > Green Ethernet

Green Ethernet			
EEE	<input type="checkbox"/>		
Auto Power Down	<input type="checkbox"/>		
Short Reach	<input type="checkbox"/>		
Port	EEE	Auto Power Down	Short Reach
*	<input type="checkbox"/>	<input type="checkbox"/>	<input type="checkbox"/>
1	<input type="checkbox"/>	<input type="checkbox"/>	<input type="checkbox"/>
2	<input type="checkbox"/>	<input type="checkbox"/>	<input type="checkbox"/>
3	<input type="checkbox"/>	<input type="checkbox"/>	<input type="checkbox"/>
4	<input type="checkbox"/>	<input type="checkbox"/>	<input type="checkbox"/>
5	<input type="checkbox"/>	<input type="checkbox"/>	<input type="checkbox"/>
6	<input type="checkbox"/>	<input type="checkbox"/>	<input type="checkbox"/>
7	<input type="checkbox"/>	<input type="checkbox"/>	<input type="checkbox"/>
8	<input type="checkbox"/>	<input type="checkbox"/>	<input type="checkbox"/>
9	<input type="checkbox"/>	<input type="checkbox"/>	<input type="checkbox"/>

The following table describes the labels in this screen.

Table 135 Advanced Application > Green Ethernet

LABEL	DESCRIPTION
EEE	Select this to activate Energy Efficient Ethernet globally.
Auto Power Down	Select this to activate Auto Power Down globally.
Short Reach	Select this to activate Short Reach globally.
Port	This field displays the port number.
*	Use this row to make the setting the same for all ports. Use this row first and then make adjustments to each port if necessary. Changes in this row are copied to all the ports as soon as you make them.
EEE	Select this to activate Energy Efficient Ethernet on this port.
Auto Power Down	Select this to activate Auto Power Down on this port.
Short Reach	Select this to activate Short Reach on this port.
Apply	Click Apply to save your changes to the Switch's run-time memory. The Switch loses these changes if it is turned off or loses power, so use the Save link on the top navigation panel to save your changes to the non-volatile memory when you are done configuring.
Cancel	Click Cancel to begin configuring this screen afresh.

CHAPTER 35

Link Layer Discovery Protocol (LLDP)

35.1 LLDP Overview

The LLDP (Link Layer Discovery Protocol) is a layer 2 protocol. It allows a network device to advertise its identity and capabilities on the local network. It also allows the device to maintain and store information from adjacent devices which are directly connected to the network device. This helps an administrator discover network changes and perform necessary network reconfiguration and management. The device information is encapsulated in the LLDPDUs (LLDP data units) in the form of TLV (Type, Length, Value). Device information carried in the received LLDPDUs is stored in the standard MIB.

The Switch supports these basic management TLVs.

- End of LLDPDU (mandatory)
- Chassis ID (mandatory)
- Port ID (mandatory)
- Time to Live (mandatory)
- Port Description (optional)
- System Name (optional)
- System Description (optional)
- System Capabilities (optional)
- Management Address (optional)

The Switch also supports the IEEE 802.1 and IEEE 802.3 organizationally-specific TLVs.

IEEE 802.1 specific TLVs:

- Port VLAN ID TLV (optional)
- Port and Protocol VLAN ID TLV (optional)

IEEE 802.3 specific TLVs:

- MAC/PHY Configuration/Status TLV (optional)
- Link Aggregation TLV (optional)
- Maximum Frame Size TLV (optional)

The optional TLVs are inserted between the Time To Live TLV and the End of LLDPDU TLV.

The next figure demonstrates that the network devices Switches and Routers (S and R) transmit and receive device information via LLDPDU and the network manager can query the information using Simple Network Management Protocol (SNMP).

Figure 212 LLDP Overview

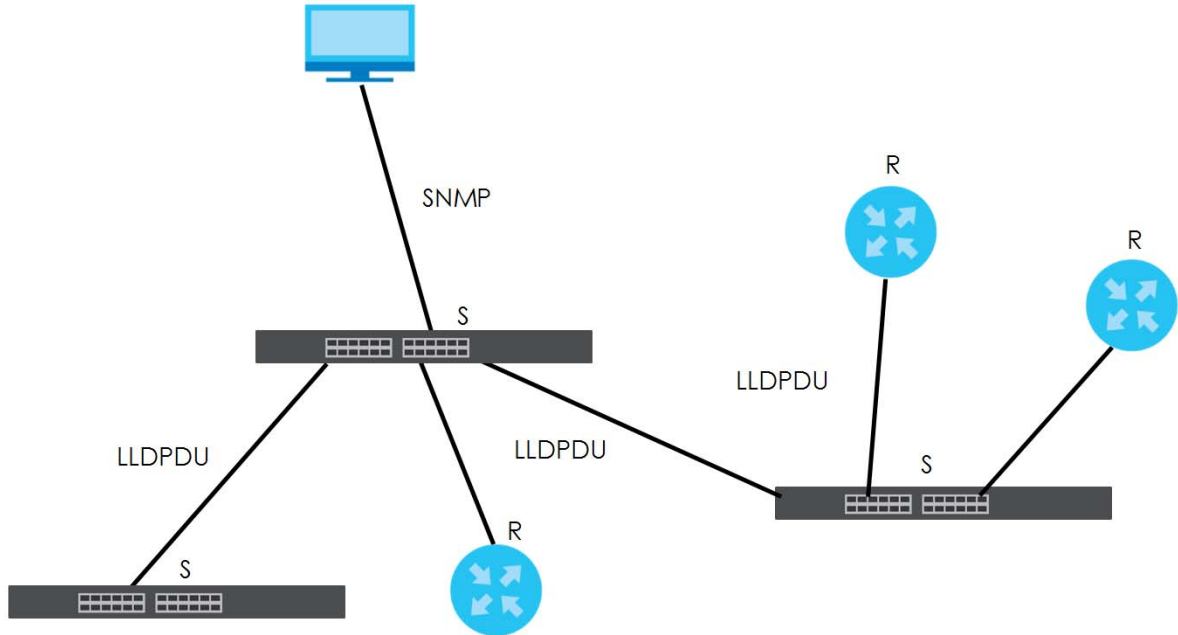

35.2 LLDP-MED Overview

LLDP-MED (Link Layer Discovery Protocol for Media Endpoint Devices) is an extension to the standard LLDP developed by the Telecommunications Industry Association (TIA) TR-41.4 subcommittee which defines the enhanced discovery capabilities, such as VoIP applications, to enable network administrators manage their network topology application more efficiently. Unlike the traditional LLDP, which has some limitations when handling multiple application devices, the LLDP-MED offers display of accurate physical topology, interoperability of devices, and easy trouble shooting for mis-configured IP addresses. There are three classes of endpoint devices that the LLDP-MED supports:

Class I: IP Communications Controllers or other communication related servers

Class II: Voice Gateways, Conference Bridges or Media Servers

Class III: IP-Phones, PC-based Softphones, End user Communication Appliances supporting IP Media

The following figure shows that with the LLDP-MED, network connectivity devices (NCD) like Switches and Routers will transmit LLDP TLV to endpoint device (ED) like IP Phone first (1), to get its device type and capabilities information, then it will receive that information in LLDP-MED TLV back from endpoint devices (2), after that the network connectivity devices will transmit LLDP-MED TLV (3) to provision the endpoint device to such that the endpoint device's network policy and location identification information is updated. Since LLDPDU updates status and configuration information periodically, network managers may check the result of provision via remote status. The remote status is updated by receiving LLDP-MED TLVs from endpoint devices.

Figure 213 LLDP-MED Overview

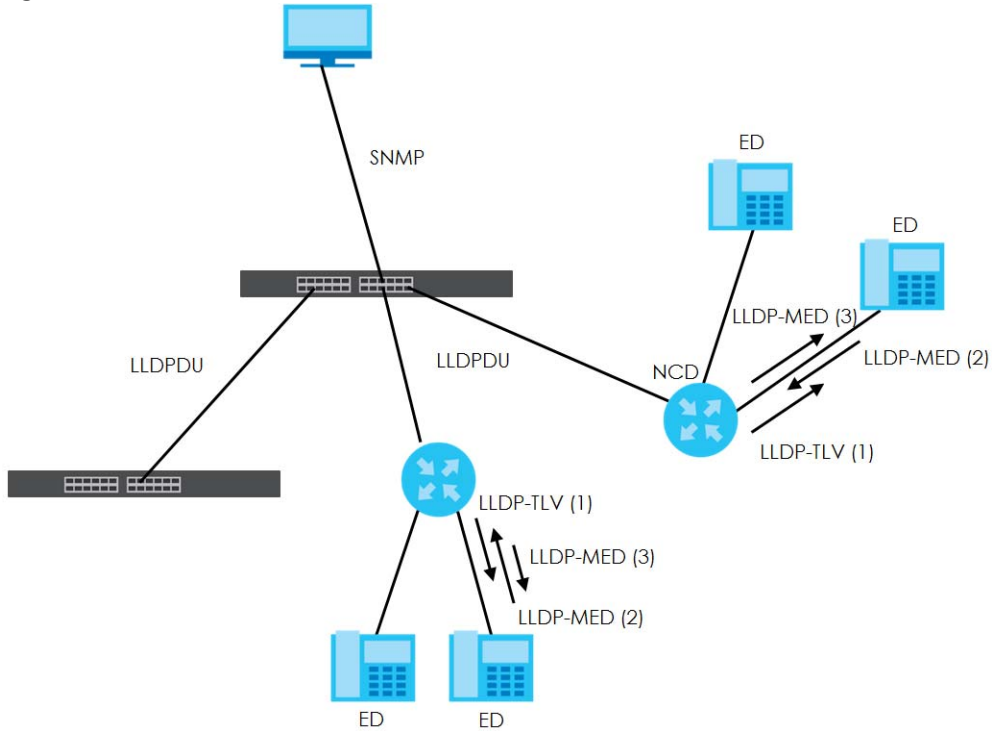

35.3 LLDP Settings

Click **Advanced Application** > **LLDP** in the navigation panel to display the screen as shown next.

Figure 214 Advanced Application > LLDP

LLDP		
LLDP	LLDP Local Status	Click here
	LLDP Remote Status	Click here
	LLDP Configuration	Click here
LLDP-MED	LLDP-MED Configuration	Click here
	LLDP-MED Network Policy	Click here
	LLDP-MED Location	Click here

The following table describes the labels in this screen.

Table 136 Advanced Application > LLDP

LABEL	DESCRIPTION
LLDP	
LLDP Local Status	Click here to show a screen with the Switch's LLDP information.
LLDP Remote Status	Click here to show a screen with LLDP information from the neighboring devices.

Table 136 Advanced Application > LLDP (continued)

LABEL	DESCRIPTION
LLDP Configuration	Click here to show a screen to configure LLDP parameters.
LLDP-MED	
LLDP-MED Configuration	Click here to show a screen to configure LLDP-MED (Link Layer Discovery Protocol for Media Endpoint Devices) parameters.
LLDP-MED Network Policy	Click here to show a screen to configure LLDP-MED (Link Layer Discovery Protocol for Media Endpoint Devices) network policy parameters.
LLDP-MED Location	Click here to show a screen to configure LLDP-MED (Link Layer Discovery Protocol for Media Endpoint Devices) location parameters.

35.4 LLDP Local Status

This screen displays a summary of LLDP status on this Switch. Click **Advanced Application > LLDP > LLDP Local Status** to display the screen as shown next.

Figure 215 Advanced Application > LLDP > LLDP Local Status

LLDP Local Status [LLDP](#)

LLDP System Information

Basic TLV		
Chassis ID TLV	Chassis ID Subtype	mac-address
	Chassis ID	bc:cf:4f:b7:4a:91
System Name TLV	System Name	XXXXXXXX
System Description TLV	System Description	V47012001-0100 001042020
System Capabilities TLV	System Capabilities Supported	Bridge
	System Capabilities Enabled	Bridge
Management Address TLV	Management Address Subtype	ipv4 / all-802
	Interface Number Subtype	unknown
	Interface Number	0
	Object Identifier	0

LLDP Port Information

Local Port	Port ID Subtype	Port ID	Port Description
1	local-assigned	1	
2	local-assigned	2	
3	local-assigned	3	
4	local-assigned	4	
5	local-assigned	5	
6	local-assigned	6	
7	local-assigned	7	
8	local-assigned	8	
9	local-assigned	9	

The following table describes the labels in this screen.

Table 137 Advanced Application > LLDP > LLDP Local Status

LABEL	DESCRIPTION
Basic TLV	
Chassis ID TLV	This displays the chassis ID of the local Switch, that is the Switch you are configuring. The chassis ID is identified by the chassis ID subtype. Chassis ID Subtype – this displays how the chassis of the Switch is identified. Chassis ID – This displays the chassis ID of the local Switch.
System Name TLV	This shows the host name of the Switch.
System Description TLV	This shows the firmware version of the Switch.
System Capabilities TLV	This shows the System Capabilities enabled and supported on the local Switch. <ul style="list-style-type: none"> • System Capabilities Supported – Bridge • System Capabilities Enabled – Bridge
Management Address TLV	The Management Address TLV identifies an address associated with the local LLDP agent that may be used to reach higher layer entities to assist discovery by network management. The TLV may also include the system interface number and an object identifier (OID) that are associated with this management address. This field displays the Management Address settings on the specified ports. <ul style="list-style-type: none"> • Management Address Subtype – ipv4 or all-802 • Interface Number Subtype – unknown • Interface Number – 0 (not supported) • Object Identifier – 0 (not supported)
LLDP Port Information	This displays the local port information.
Local Port	This displays the number of the Switch port which receives the LLDPDU from the remote device. Click a port number to view the detailed LLDP status on this port in the LLDP Local Port Status Detail screen.
Port ID Subtype	This indicates how the port ID field is identified.
Port ID	This is an alpha-numeric string that contains the specific identifier for the port from which this LLDPDU was transmitted.
Port Description	This shows the port description that the Switch will advertise from this port.

35.4.1 LLDP Local Port Status Detail

This screen displays detailed LLDP status for each port on this Switch. Click **Advanced Application > LLDP > LLDP Local Status** and then, click a port number, for example 1 in the local port column to display the screen as shown next.

Figure 216 Advanced Application > LLDP > LLDP Local Status > LLDP Local Port Status Detail (Basic TLV)

LLDP Local Port Status Detail		LLDP Local Status
Local Port: 1		
Basic TLV		
Port ID TLV	Port ID Subtype	local-assigned
	Port ID	1
Port Description TLV	Port Description	
Dot1 TLV		
Port VLAN ID TLV	Port VLAN ID	1
Port-Protocol VLAN ID TLV	Port-Protocol VLAN ID	
Dot3 TLV		
MAC PHY Configuration & Status TLV	AN Supported	Yes
	AN Enabled	Yes
	AN Advertised Capability	100baseTX 100baseTXFD 1000baseTFD
	Oper MAU Type	30
Link Aggregation TLV	Aggregation Capability	Yes
	Aggregation Status	No
	Aggregated Port ID	0
Max Frame Size TLV	Max Frame Size	1518

Figure 217 Advanced Application > LLDP > LLDP Local Status > LLDP Local Port Status Detail (MED TLV)

MED TLV		
Capabilities TLV	Network Policy	Yes
	Location	Yes
	Extend Power via MDI PSE	No
	Extend Power via MDI PD	No
	Inventory Management	No
Device Type TLV	Device Type	Network Connectivity
Network Policy TLV	Voice	
	Voice-Signaling	
	Guest-Voice	
	Guest-Voice-Signaling	
	Softphone-Voice	
	Video-Conferencing	
	Streaming-Video	
Location Identification TLV	Coordinate-base LCI	
	Civic LCI	
	ELIN	

The following table describes the labels in this screen.

Table 138 Advanced Application > LLDP > LLDP Local Status > LLDP Local Port Status Detail

LABEL	DESCRIPTION
Local Port	This displays the number of the Switch's port.
Basic TLV	These are the Basic TLV flags

Table 138 Advanced Application > LLDP > LLDP Local Status > LLDP Local Port Status Detail (continued)

LABEL	DESCRIPTION
Port ID TLV	The port ID TLV identifies the specific port that transmitted the LLDP frame. <ul style="list-style-type: none"> • Port ID Subtype: This shows how the port is identified. • Port ID: This is the ID of the port.
Port Description TLV	This displays the local port description.
Dot1 TLV	
Port VLAN ID TLV	This displays the VLAN ID sent by the IEEE 802.1 Port VLAN ID TLV.
Port Protocol VLAN ID TLV	This displays the IEEE 802.1 Port Protocol VLAN ID TLVs, which indicates whether the VLAN is enabled and supported.
Dot3 TLV	
MAC PHY Configuration & Status TLV	The MAC/PHY Configuration/Status TLV advertises the bit-rate and duplex capability of the sending 802.3 node. It also advertises the current duplex and bit-rating of the sending node. Lastly, it advertises whether these setting were the result of auto-negotiation during link initiation or manual override. <ul style="list-style-type: none"> • AN Supported – Displays if the port supports or does not support auto-negotiation. • AN Enabled – The current auto-negotiation status of the port. • AN Advertised Capability – The auto-negotiation capabilities of the port. • Oper MAU Type – The current Medium Attachment Unit (MAU) type of the port.
Link Aggregation TLV	The Link Aggregation TLV indicates whether the link is capable of being aggregated, whether the link is currently in an aggregation, and if in an aggregation, the port identification of the aggregation. <ul style="list-style-type: none"> • Aggregation Capability – The current aggregation capability of the port. • Aggregation Status – The current aggregation status of the port. • Aggregation Port ID – The aggregation ID of the current port.
Max Frame Size TLV	This displays the maximum supported frame size in octets.
MED TLV	LLDP Media Endpoint Discovery (MED) is an extension of LLDP that provides additional capabilities to support media endpoint devices. MED enables advertisement and discovery of network policies, device location discovery to allow creation of location databases, and information for troubleshooting.
Capabilities TLV	This field displays which LLDP-MED TLV are capable to transmit on the Switch. <ul style="list-style-type: none"> • Network Policy • Location • Extend Power via MDI PSE • Extend Power via MDI PD • Inventory Management
Device Type TLV	This is the LLDP-MED device class. The Zyxel Switch device type is: <ul style="list-style-type: none"> • Network Connectivity

Table 138 Advanced Application > LLDP > LLDP Local Status > LLDP Local Port Status Detail (continued)

LABEL	DESCRIPTION
Network Policy TLV	This displays a network policy for the specified application. <ul style="list-style-type: none"> • Voice • Voice-Signaling • Guest-Voice • Guest-Voice-Signaling • Softphone-Voice • Video-Conferencing • Streaming-Video • Video-Signaling
Location Identification TLV	This shows the location information of a caller by its ELIN (Emergency Location Identifier Number) or the IETF Geopriv Civic Address based Location Configuration Information (Civic Address LCI). <ul style="list-style-type: none"> • Coordinate-based LCI – latitude, longitude and altitude coordinates of the location Configuration Information (LCI) • Civic LCI – IETF Geopriv Civic Address based Location Configuration Information • ELIN – (Emergency Location Identifier Number)

35.5 LLDP Remote Status

This screen displays a summary of LLDP status for each LLDP connection to a neighboring Switch. Click **Advanced Application > LLDP > LLDP Remote Status (Click Here)** to display the screen as shown next.

Figure 218 Advanced Application > LLDP > LLDP Remote Status

LLDP Remote Status							LLDP
Index	Local Port	Chassis ID	Port ID	Port Description	System Name	Management Address	
1	1	08:26:97:c4:cc:a2	08:26:97:c4:c c:a2				
2	1	0a:26:97:c4:cc:a4	08:26:97:c4:c c:a2				
3	3	dc:4a:3e:40:ec:5f	dc:4a:3e:40:e c:5f				
4	5	e4:18:6b:f7:ba:0d	39		12A3_84	e4:18:6b:f7:ba:0d	

The following table describes the labels in this screen.

Table 139 Advanced Application > LLDP > LLDP Remote Status

LABEL	DESCRIPTION
Index	The index number shows the number of remote devices that are connected to the Switch. Click on an index number to view the detailed LLDP status for this remote device in the LLDP Remote Port Status Detail screen.
Local Port	This is the number of the Switch's port that received LLDPDU from the remote device.
Chassis ID	This displays the chassis ID of the remote device associated with the transmitting LLDP agent. The chassis ID is identified by the chassis ID subtype. For example, the MAC address of the remote device.
Port ID	This is an alpha-numeric string that contains the specific identifier for the port from which this LLDPDU was transmitted. The port ID is identified by the port ID subtype.
Port Description	This displays a description for the port from which this LLDPDU was transmitted.

Table 139 Advanced Application > LLDP > LLDP Remote Status (continued)

LABEL	DESCRIPTION
System Name	This displays the system name of the remote device.
Management Address	This displays the management address of the remote device. It could be the MAC address or IP address.

35.5.1 LLDP Remote Port Status Detail

This screen displays detailed LLDP status of the remote device connected to the Switch. Click **Advanced Application > LLDP > LLDP Remote Status (Click Here)** and then click an index number, for example 1, in the **Index** column in the **LLDP Remote Status** screen to display the screen as shown next.

Figure 219 Advanced Application > LLDP > LLDP Remote Status > LLDP Remote Port Status Detail (Basic TLV)

The screenshot shows the 'LLDP Remote Port Status Detail' screen. At the top, it says 'Local Port: 6' and 'LLDP Remote Status'. Below this is a table of TLV fields:

Basic TLV		
Chassis ID TLV	Chassis ID Subtype	mac-address
	Chassis ID	e4:18:6b:f7:ba:0d
Port ID TLV	Port ID Subtype	local-assigned
	Port ID	39
Time To Live TLV	Time To Live	120
Port Description TLV	Port Description	
System Name TLV	System Name	12A3_84
System Description TLV	System Description	V4.30(AAGE.2) 12/12/2018
System Capabilities TLV	System Capabilities Supported	bridge
	System Capabilities Enabled	bridge
Management Address TLV	Management Address Subtype	ALL_802
	Management Address	e4:18:6b:f7:ba:0d
	Interface Number Subtype	unknown
	Interface Number	0
	Object Identifier	

The following table describes the labels in Basic TLV part of the screen.

Table 140 Advanced Application > LLDP > LLDP Remote Status > LLDP Remote Port Status Detail (Basic TLV)

LABEL	DESCRIPTION
Local Port	This displays the number of the Switch's port to which the remote device is connected.
Basic TLV	
Chassis ID TLV	<ul style="list-style-type: none"> Chassis ID Subtype – this displays how the chassis of the remote device is identified. Chassis ID – this displays the chassis ID of the remote device. The chassis ID is identified by the chassis ID subtype.

Table 140 Advanced Application > LLDP > LLDP Remote Status > LLDP Remote Port Status Detail (Basic TLV) (continued)

LABEL	DESCRIPTION
Port ID TLV	<ul style="list-style-type: none"> • Port ID Subtype – this displays how the port of the remote device is identified. • Port ID – this displays the port ID of the remote device. The port ID is identified by the port ID subtype.
Time To Live TLV	This displays the time-to-live (TTL) multiplier of LLDP frames. The device information on the neighboring devices ages out and is discarded when its corresponding TTL expires. The TTL value is to multiply the TTL multiplier by the LLDP frames transmitting interval.
Port Description TLV	This displays the remote port description.
System Name TLV	This displays the system name of the remote device.
System Description TLV	This displays the system description of the remote device.
System Capabilities TLV	<p>This displays whether the system capabilities are enabled and supported on the remote device.</p> <ul style="list-style-type: none"> • System Capabilities Supported • System Capabilities Enabled
Management Address TLV	<p>This displays the management address of the remote device.</p> <ul style="list-style-type: none"> • Management Address Subtype • Management Address • Interface Number Subtype • Interface Number • Object Identifier

Figure 220 Advanced Application > LLDP > LLDP Remote Status > LLDP Remote Port Status Detail (Dot 1 and Dot3 TLV)

Dot1 TLV		
Port VLAN ID TLV	Port VLAN ID	
Port-Protocol VLAN ID TLV	Port-Protocol VLAN ID	
	Port-Protocol VLAN ID Supported	
	Port-Protocol VLAN ID Enabled	
Vlan Name TLV	VLAN ID	
	VLAN Name	
Protocol Identity TLV	Protocol ID	
Dot3 TLV		
MAC PHY Configuration & Status TLV	AN Supported	No
	AN Enabled	No
	AN Advertised Capability	
	Oper MAU type	0
Link Aggregation TLV	Aggregation Capability	Yes
	Aggregation Status	No
	Aggregated Port ID	0
Power Via MDI TLV	Port Class	
	MDI Supported	
	MDI Enabled	
	Pair Controlable	
	PSE Power Pairs	
	Power Class	
Max Frame Size TLV	Max Frame Size	

The following table describes the labels in the Dot1 and Dot3 parts of the screen.

Table 141 Advanced Application > LLDP > LLDP Remote Status > LLDP Remote Port Status Detail (Dot1 and Dot3 TLV)

LABEL	DESCRIPTION
Dot1 TLV	
Port VLAN ID TLV	This displays the VLAN ID of this port on the remote device.
Port-Protocol VLAN ID TLV	This displays the IEEE 802.1 Port Protocol VLAN ID TLV, which indicates whether the VLAN ID and whether it is enabled and supported on the port of remote Switch which sent the LLDPDU. <ul style="list-style-type: none"> • Port-Protocol VLAN ID • Port-Protocol VLAN ID Supported • Port-Protocol VLAN ID Enabled

Table 141 Advanced Application > LLDP > LLDP Remote Status > LLDP Remote Port Status Detail (Dot1 and Dot3 TLV) (continued)

LABEL	DESCRIPTION
Vlan Name TLV	<p>This shows the VLAN ID and name for remote device port.</p> <ul style="list-style-type: none"> • VLAN ID • VLAN Name
Protocol Identity TLV	<p>The Protocol Identity TLV allows the Switch to advertise the particular protocols that are accessible through its port.</p>
Dot3 TLV	
MAC PHY Configuration & Status TLV	<p>The MAC/PHY Configuration/Status TLV advertises the bit-rate and duplex capability of the sending 802.3 node. It also advertises the current duplex and bit-rating of the sending node. Lastly, it advertises whether these setting were the result of auto-negotiation during link initiation or manual override.</p> <ul style="list-style-type: none"> • AN Supported – Displays if the port supports or does not support auto-negotiation. • AN Enabled – The current auto-negotiation status of the port. • AN Advertised Capability – The auto-negotiation capabilities of the port. • Oper MAU Type – The current Medium Attachment Unit (MAU) type of the port.
Link Aggregation TLV	<p>The Link Aggregation TLV indicates whether the link is capable of being aggregated, whether the link is currently in an aggregation, and if in an aggregation, the port identification of the aggregation.</p> <ul style="list-style-type: none"> • Aggregation Capability – The current aggregation capability of the port. • Aggregation Status – The current aggregation status of the port. • Aggregation Port ID – The aggregation ID of the current port.
Power Via MDI TLV	<p>The Power Via MDI TLV allows network management to advertise and discover the MDI power support capabilities of the sending port on the remote device.</p> <ul style="list-style-type: none"> • Port Class • MDI Supported • MDI Enabled • Pair Controllable • PSE Power Pairs • Power Class
Max Frame Size TLV	<p>This displays the maximum supported frame size in octets.</p>

Figure 221 Advanced Application > LLDP > LLDP Remote Status > LLDP Remote Port Status Detail (MED TLV)

MED TLV	
Capabilities TLV	Network Policy
	Location
	Extend Power via MDI PSE
	Extend Power via MDI PD
	Inventory Management
Device Type TLV	Device Type
Network Policy TLV	Voice
	Voice-Signaling
	Guest-Voice
	Guest-Voice-Signaling
	Softphone-Voice
	Video-Conferencing
	Streaming-Video
	Video-Signaling
Location Identification TLV	Coordinate-base LCI
	Civic LCI
	ELIN
Inventory TLV	Hardware Revision
	Software Revision
	Firmware Revision
	Model Name
	Manufacturer
	Serial Number
	Asset ID
Extended Power via MDI TLV	Power Type
	Power Source
	Power Priority
	Power Value

The following table describes the labels in the MED TLV part of the screen.

Table 142 Advanced Application > LLDP > LLDP Remote Status > LLDP Remote Port Status Detail (MED TLV)

LABEL	DESCRIPTION
MED TLV	LLDP Media Endpoint Discovery (MED) is an extension of LLDP that provides additional capabilities to support media endpoint devices. MED enables advertisement and discovery of network policies, device location discovery to allow creation of location databases, and information for troubleshooting.
Capabilities TLV	This displays the MED capabilities the remote port supports. <ul style="list-style-type: none"> • Network Policy • Location • Extend Power via MDI PSE • Extend Power via MDI PD • Inventory Management
Device Type TLV	LLDP-MED endpoint device classes: <ul style="list-style-type: none"> • Endpoint Class I • Endpoint Class II • Endpoint Class III • Network Connectivity
Network Policy TLV	This displays a network policy for the specified application. <ul style="list-style-type: none"> • Voice • Voice-Signaling • Guest-Voice • Guest-Voice-Signaling • Softphone-Voice • Video-Conferencing • Streaming-Video • Video-Signaling
Location Identification TLV	This shows the location information of a caller by its: <ul style="list-style-type: none"> • Coordinate-base LCI – latitude and longitude coordinates of the Location Configuration Information (LCI) • Civic LCI – IETF Geopriv Civic Address based Location Configuration Information • ELIN – (Emergency Location Identifier Number)
Inventory TLV	The majority of IP Phones lack support of management protocols such as SNMP, so LLDP-MED inventory TLVs are used to provide their inventory information to the Network Connectivity Devices such as the Switch. The Inventory TLV may contain the following information. <ul style="list-style-type: none"> • Hardware Revision • Software Revision • Firmware Revision • Model Name • Manufacturer • Serial Number • Asset ID
Extended Power via MDI TLV	Extended Power Via MDI Discovery enables detailed power information to be advertised by Media Endpoints, such as IP phones and Network Connectivity Devices such as the Switch. <ul style="list-style-type: none"> • Power Type – whether it is currently operating from primary power or is on backup power (backup power may indicate to the Endpoint Device that it should move to a power conservation mode). • Power Source – whether or not the Endpoint is currently operating from an external power source. • Power Priority – the Endpoint Device's power priority (which the Network Connectivity Device may use to prioritize which devices will remain in service during power shortages). • Power Value – power requirement, in fractions of Watts, in current configuration.

35.6 LLDP Configuration

Use this screen to configure global LLDP settings on the Switch. Click **Advanced Application > LLDP > LLDP Configuration (Click Here)** to display the screen as shown next.

Figure 222 Advanced Application > LLDP > LLDP Configuration

The following table describes the labels in this screen.

Table 143 Advanced Application > LLDP > LLDP Configuration

LABEL	DESCRIPTION
Active	Select to enable LLDP on the Switch. It is enabled by default.
Transmit Interval	Enter how many seconds the Switch waits before sending LLDP packets.
Transmit Hold	Enter the time-to-live (TTL) multiplier of LLDP frames. The device information on the neighboring devices ages out and is discarded when its corresponding TTL expires. The TTL value is to multiply the TTL multiplier by the LLDP packets transmitting interval.
Transmit Delay	Enter the delay (in seconds) between successive LLDPDU transmissions initiated by value or status changes in the Switch MIB.
Reinitialize Delay	Enter the number of seconds for LLDP to wait before initializing on a port.
Apply	Click Apply to save your changes to the Switch's run-time memory. The Switch loses these changes if it is turned off or loses power, so use the Save link on the top navigation panel to save your changes to the non-volatile memory when you are done configuring.
Cancel	Click Cancel to begin configuring this screen afresh.
Port	This displays the Switch's port number. * means all ports.
*	Use this row to make the setting the same for all ports. Use this row first and then make adjustments to each port if necessary. Changes in this row are copied to all the ports as soon as you make them.

Table 143 Advanced Application > LLDP > LLDP Configuration (continued)

LABEL	DESCRIPTION
Admin Status	Select whether LLDP transmission and/or reception is allowed on this port. <ul style="list-style-type: none"> • Disable – not allowed • Tx-Only – transmit only • Rx-Only – receive only • Tx-Rx – transmit and receive
Notification	Select whether LLDP notification is enabled on this port.
Apply	Click Apply to save your changes to the Switch's run-time memory. The Switch loses these changes if it is turned off or loses power, so use the Save link on the top navigation panel to save your changes to the non-volatile memory when you are done configuring.
Cancel	Click Cancel to begin configuring this screen afresh.

35.6.1 LLDP Configuration Basic TLV Setting

Use this screen to configure Basic TLV settings. Click **Advanced Application > LLDP > LLDP Configuration (Click Here) > Basic TLV Setting** to display the screen as shown next.

Figure 223 Advanced Application > LLDP > LLDP Configuration > Basic TLV Setting

Basic TLV Setting						LLDP Configuration
Port	Management Address	Port Description	System Capabilities	System Description	System Name	
*	<input type="checkbox"/>	<input type="checkbox"/>	<input type="checkbox"/>	<input type="checkbox"/>	<input type="checkbox"/>	<input type="checkbox"/>
1	<input checked="" type="checkbox"/>	<input checked="" type="checkbox"/>	<input checked="" type="checkbox"/>	<input checked="" type="checkbox"/>	<input checked="" type="checkbox"/>	<input checked="" type="checkbox"/>
2	<input checked="" type="checkbox"/>	<input checked="" type="checkbox"/>	<input checked="" type="checkbox"/>	<input checked="" type="checkbox"/>	<input checked="" type="checkbox"/>	<input checked="" type="checkbox"/>
3	<input checked="" type="checkbox"/>	<input checked="" type="checkbox"/>	<input checked="" type="checkbox"/>	<input checked="" type="checkbox"/>	<input checked="" type="checkbox"/>	<input checked="" type="checkbox"/>
4	<input checked="" type="checkbox"/>	<input checked="" type="checkbox"/>	<input checked="" type="checkbox"/>	<input checked="" type="checkbox"/>	<input checked="" type="checkbox"/>	<input checked="" type="checkbox"/>
5	<input checked="" type="checkbox"/>	<input checked="" type="checkbox"/>	<input checked="" type="checkbox"/>	<input checked="" type="checkbox"/>	<input checked="" type="checkbox"/>	<input checked="" type="checkbox"/>
6	<input checked="" type="checkbox"/>	<input checked="" type="checkbox"/>	<input checked="" type="checkbox"/>	<input checked="" type="checkbox"/>	<input checked="" type="checkbox"/>	<input checked="" type="checkbox"/>
7	<input checked="" type="checkbox"/>	<input checked="" type="checkbox"/>	<input checked="" type="checkbox"/>	<input checked="" type="checkbox"/>	<input checked="" type="checkbox"/>	<input checked="" type="checkbox"/>
8	<input checked="" type="checkbox"/>	<input checked="" type="checkbox"/>	<input checked="" type="checkbox"/>	<input checked="" type="checkbox"/>	<input checked="" type="checkbox"/>	<input checked="" type="checkbox"/>
9	<input checked="" type="checkbox"/>	<input checked="" type="checkbox"/>	<input checked="" type="checkbox"/>	<input checked="" type="checkbox"/>	<input checked="" type="checkbox"/>	<input checked="" type="checkbox"/>

The following table describes the labels in this screen.

Table 144 Advanced Application > LLDP > LLDP Configuration > Basic TLV Setting

LABEL	DESCRIPTION
Port	This displays the Switch's port number.
*	Use this row to make the setting the same for all ports. Use this row first and then make adjustments to each port if necessary. Changes in this row are copied to all the ports as soon as you make them.
Management Address	Select the check boxes to enable or disable the sending of Management Address TLVs on the ports.
Port Description	Select the check boxes to enable or disable the sending of Port Description TLVs on the ports.
System Capabilities	Select the check boxes to enable or to disable the sending of System Capabilities TLVs on the ports.
System Description	Select the check boxes to enable or to disable the sending of System Description TLVs on the ports.

Table 144 Advanced Application > LLDP > LLDP Configuration > Basic TLV Setting (continued)

LABEL	DESCRIPTION
System Name	Select the check boxes to enable or to disable the sending of System Name TLVs on the ports.
Apply	Click Apply to save your changes to the Switch's run-time memory. The Switch loses these changes if it is turned off or loses power, so use the Save link on the top navigation panel to save your changes to the non-volatile memory when you are done configuring.
Cancel	Click Cancel to begin configuring this screen afresh.

35.6.2 LLDP Configuration Org-specific TLV Setting

Use this screen to configure organization-specific TLV settings. Click **Advanced Application > LLDP > LLDP Configuration (Click Here) > Org-specific TLV Setting** to display the screen as shown next.

Figure 224 Advanced Application > LLDP > LLDP Configuration > Org-specific TLV Setting

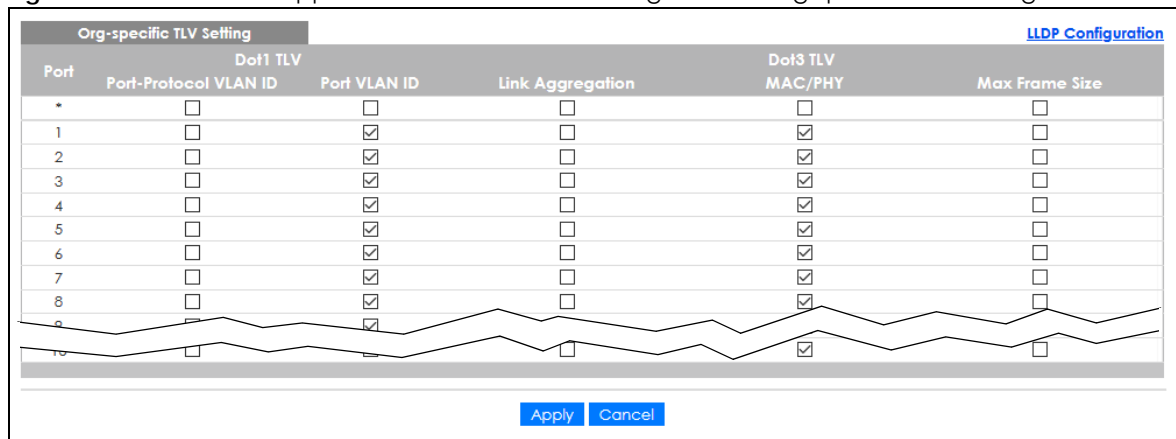

The following table describes the labels in this screen.

Table 145 Advanced Application > LLDP > LLDP Configuration > Org-specific TLV Setting

LABEL	DESCRIPTION
Port	This displays the Switch's port number.
*	Use this row to make the setting the same for all ports. Use this row first and then make adjustments to each port if necessary. Changes in this row are copied to all the ports as soon as you make them.
Dot1 TLV	
Port-Protocol VLAN ID	Select the check boxes to enable or disable the sending of IEEE 802.1 Port and Protocol VLAN ID TLVs on the ports.
Port VLAN ID	Select the check boxes to enable or disable the sending of IEEE 802.1 Port VLAN ID TLVs on the ports. All check boxes in this column are enabled by default.
Dot3 TLV	
Link Aggregation	Select the check boxes to enable or disable the sending of IEEE 802.3 Link Aggregation TLVs on the ports.
MAC/PHY	Select the check boxes to enable or disable the sending of IEEE 802.3 MAC/PHY Configuration/Status TLVs on the ports. All check boxes in this column are enabled by default.
Max Frame Size	Select the check boxes to enable or disable the sending of IEEE 802.3 Max Frame Size TLVs on the ports.

Table 145 Advanced Application > LLDP > LLDP Configuration > Org-specific TLV Setting (continued)

LABEL	DESCRIPTION
Power Via MDI	<p>Note: For PoE models only.</p> <p>The Power Via MDI TLV allows network management to advertise and discover the MDI power support capabilities of the sending port on the remote device.</p> <ul style="list-style-type: none"> • Port Class • MDI Supported • MDI Enabled • Pair Controllable • PSE Power Pairs • Power Class
Apply	Click Apply to save your changes to the Switch's run-time memory. The Switch loses these changes if it is turned off or loses power, so use the Save link on the top navigation panel to save your changes to the non-volatile memory when you are done configuring.
Cancel	Click Cancel to begin configuring this screen afresh.

35.7 LLDP-MED Configuration

Click **Advanced Application > LLDP > LLDP-MED Configuration** to display the screen as shown next.

Figure 225 Advanced Application > LLDP > LLDP-MED Configuration

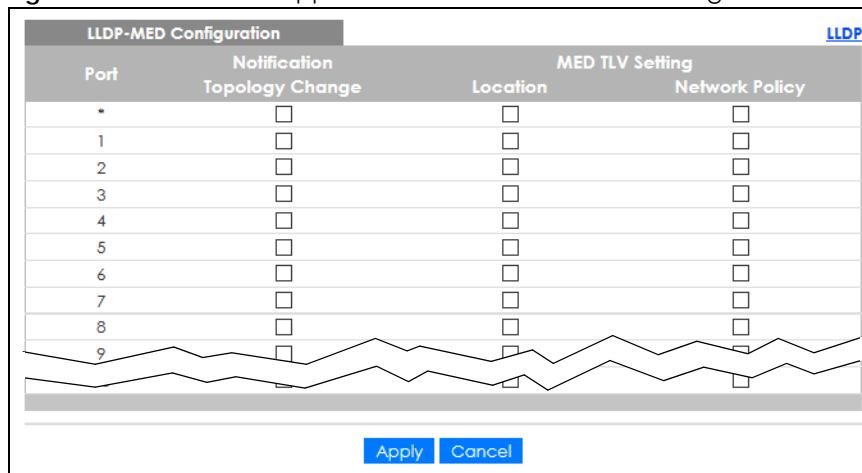

The following table describes the labels in this screen.

Table 146 Advanced Application > LLDP > LLDP-MED Configuration

LABEL	DESCRIPTION
Port	This displays the Switch's port number. Select * to configure all ports simultaneously.
*	<p>Use this row to make the setting the same for all ports. Use this row first and then make adjustments to each port if necessary.</p> <p>Changes in this row are copied to all the ports as soon as you make them.</p>
Notification	
Topology Change	Select to enable LLDP-MED topology change traps on this port.
MED TLV Setting	
Location	Select to enable transmitting LLDP-MED location TLV.

Table 146 Advanced Application > LLDP > LLDP-MED Configuration

LABEL	DESCRIPTION
Network Policy	Select to enable transmitting LLDP-MED Network Policy TLV.
Apply	Click Apply to save the changes to the Switch's run-time memory. The Switch loses these changes if it is turned off or loses power, so use the Save link on the top navigation panel to save your changes to the non-volatile memory when you are done configuring.
Cancel	Click Cancel to begin configuring this screen afresh.

35.8 LLDP-MED Network Policy

Click **Advanced Application > LLDP > LLDP-MED Network Policy (Click Here)** to display the screen as shown next.

Figure 226 Advanced Application > LLDP > LLDP-MED Network Policy

The following table describes the labels in this screen.

Table 147 Advanced Application > LLDP > LLDP-MED Network Policy

LABEL	DESCRIPTION
Port	Enter the port number to set up the LLDP-MED network policy.
Application Type	Select the type of application used in the network policy. <ul style="list-style-type: none"> • voice • voice-signaling • guest-voice • guest-voice-signaling • softphone-voice • video-conferencing • streaming-video • video-signaling
Tag	Select to tag or untag in the network policy. <ul style="list-style-type: none"> • tagged • untagged
VLAN	Enter the VLAN ID number. It should be from 1 to 4094. For priority tagged frames, enter "0".
DSCP	Enter the DSCP value of the network policy. The value is defined from 0 through 63 with the 0 representing use of the default DSCP value.

Table 147 Advanced Application > LLDP > LLDP-MED Network Policy (continued)

LABEL	DESCRIPTION
Priority	Enter the priority value for the network policy.
Add	Click Add after finish entering the network policy information. A summary table will list all the Switch you have added.
Cancel	Click Cancel to begin entering the information afresh.
Index	This field displays the of index number of the network policy. Click an index number to edit the rule.
Port	This field displays the port number of the network policy.
Application Type	This field displays the application type of the network policy.
Tag	This field displays the Tag Status of the network policy.
VLAN	This field displays the VLAN ID of the network policy.
Priority	This field displays the priority value of the network policy.
DSCP	This field displays the DSCP value of the network policy.
	Select an entry's check box to select a specific entry. Otherwise, select the check box in the table heading row to select all entries.
Delete	Check the rules that you want to remove, then click the Delete button.
Cancel	Click Cancel to clear the selected check boxes.

35.9 LLDP-MED Location

Click **Advanced Application > LLDP > LLDP-MED Location (Click Here)** to display the screen as shown next.

Figure 227 Advanced Application > LLDP > LLDP-MED Location

LLDP-MED Location		LLDP		
Port	<input type="text"/>			
Location Coordinates	Latitude	<input type="text"/>	north ▾	
	Longitude	<input type="text"/>	west ▾	
	Altitude	<input type="text"/>	meters ▾	
	Datum	WGS84 ▾		
Civic Address	Country	<input type="text"/>	State <input type="text"/>	
	County	<input type="text"/>	City <input type="text"/>	
	Division	<input type="text"/>	Neighbor <input type="text"/>	
	Street	<input type="text"/>	Leading-Street-Direction <input type="text"/>	
	Street-Suffix	<input type="text"/>	Trailing-Street-Suffix <input type="text"/>	
	House-Number	<input type="text"/>	House-Number-Suffix <input type="text"/>	
	Landmark	<input type="text"/>	Additional-Location <input type="text"/>	
	Name	<input type="text"/>	Zip-Code <input type="text"/>	
	Building	<input type="text"/>	Unit <input type="text"/>	
	Floor	<input type="text"/>	Room-Number <input type="text"/>	
	Place-Type	<input type="text"/>	Postal-Community-Name <input type="text"/>	
	Post-Office-Box	<input type="text"/>	Additional-Code <input type="text"/>	
	ELIN Number	<input type="text"/>		
<input type="button" value="Add"/> <input type="button" value="Cancel"/>				
Index	Port	Location Coordinates	Civic Address	ELIN Number
				<input type="button" value="Delete"/> <input type="button" value="Cancel"/>

The following table describes the labels in this screen.

Table 148 Advanced Application > LLDP > LLDP-MED Location

LABEL	DESCRIPTION
Port	Enter the port number you want to set up the location within the LLDP-MED network.
Location Coordinates	The LLDP-MED uses geographical coordinates and Civic Address to set the location information of the remote device. Geographical based coordinates includes latitude, longitude, altitude and datum. Civic Address includes Country, State, County, City, Street and other related information.
Latitude	Enter the latitude information. The value should be from 0° to 90°. The negative value represents the South. <ul style="list-style-type: none"> • north • south
Longitude	Enter the longitude information. The value should be from 0° to 180°. The negative value represents the West. <ul style="list-style-type: none"> • west • east

Table 148 Advanced Application > LLDP > LLDP-MED Location (continued)

LABEL	DESCRIPTION
Altitude	Enter the altitude information. The value should be from –2097151 to 2097151 in meters or in floors. <ul style="list-style-type: none"> • meters • floor
Datum	Select the appropriate geodetic datum used by GPS. <ul style="list-style-type: none"> • WGS84 • NAD83-NAVD88 • NAD83-MLLW
Civic Address	Enter the Civic Address by providing information such as Country, State, County, City, Street, Number, ZIP code and other additional information. Enter at least 2 fields in this configuration including the Country. The valid length of the Country field is 2 characters and all other fields are up to 32 characters. <ul style="list-style-type: none"> • Country • State • County • City • Division • Neighbor • Street • Leading-Street-Direction • Street-Suffix • Trailing-Street-Suffix • House-Number • House-Number-Suffix • Landmark • Additional-Location • Name • Zip-Code • Building • Unit • Floor • Room-Number • Place-Type • Postal-Community-Name • Post-Office-Box • Additional-Code
ELIN Number	Enter a numerical digit string, corresponding to the ELIN identifier which is used during emergency call setup to a traditional CAMA or ISDN trunk-based PSAP. The valid length is from 10 to 25 characters.
Add	Click Add after finish entering the location information.
Cancel	Click Cancel to begin entering the location information afresh.
Index	This lists the index number of the location configuration. Click an index number to view or edit the location.
Port	This lists the port number of the location configuration.
Location Coordinates	This field displays the location configuration information based on geographical coordinates that includes longitude, latitude, altitude and datum.
Civic Address	This field displays the Civic Address for the remote device using information such as Country, State, County, City, Street, Number, ZIP code and additional information.
ELIN Number	This field shows the Emergency Location Identification Number (ELIN), which is used to identify endpoint devices when they issue emergency call services. The valid length is form 10 to 25 characters.
	Select an entry's check box to select a specific entry. Otherwise, select the check box in the table heading row to select all entries.

Table 148 Advanced Application > LLDP > LLDP-MED Location (continued)

LABEL	DESCRIPTION
Delete	Check the locations that you want to remove, then click the Delete button.
Cancel	Click Cancel to clear the selected check boxes.

CHAPTER 36

OAM

36.1 OAM Overview

Link layer Ethernet OAM (Operations, Administration and Maintenance) as described in IEEE 802.3ah is a link monitoring protocol. It utilizes OAM Protocol Data Units or OAM PDUs to transmit link status information between directly connected Ethernet devices. Both devices must support IEEE 802.3ah. Because link layer Ethernet OAM operates at layer two of the OSI (Open Systems Interconnection Basic Reference) model, neither IP or SNMP are necessary to monitor or troubleshoot network connection problems.

The Switch supports the following IEEE 802.3ah features:

- Discovery – this identifies the devices on each end of the Ethernet link and their OAM configuration.
- Remote Loopback – this can initiate a loopback test between Ethernet devices.

36.1.1 What You Can Do

- Use the **OAM Status** screen ([Section 36.2 on page 313](#)) to view the configuration of ports on which Ethernet OAM is enabled.
- Use the **OAM Configuration** screen ([Section 36.3 on page 317](#)) to enable Ethernet OAM on the Switch.
- Use the **OAM Remote Loopback** screen ([Section 36.4 on page 319](#)) to perform remote-loopback tests.

36.2 OAM Status

Use this screen to view the configuration of ports on which Ethernet OAM is enabled. Click **Advanced Application > OAM** in the navigation panel.

Figure 228 Advanced Application > OAM Status

Local		Remote			
Port	Mode	Mac Address	OUI	Mode	Config
1					
2					
3					
4					
5					
6					
7					
8					
9					
10					
11					
12					
13					
14					
15					
16					
17					
18					
19					
20					
21					
22					
23					
24					

The following table describes the fields in the above screen.

Table 149 Advanced Application > OAM Status

LABEL	DESCRIPTION
Local	
	This section displays information about the ports on the Switch.
Port	This field displays the port number.
Mode	This field displays the operational state of the port when OAM is enabled on the port. Active – Allows the port to issue and respond to Ethernet OAM commands. Passive – Allows the port to respond to Ethernet OAM commands.
Remote	
	This section displays information about the remote device.
Mac Address	This field displays the MAC address of the remote device.
OUI	This field displays the OUI (first 3 bytes of the MAC address) of the remote device.
Mode	This field displays the operational state of the port when OAM is enabled on the port. Active – Allows the port to issue and respond to Ethernet OAM commands. Passive – Allows the port to respond to Ethernet OAM commands.
Config	This field displays the capabilities of the Switch and remote device.

36.2.1 OAM Details

Use this screen to view OAM configuration details and operational status of a specific port. Click a number in the **Port** column in the **OAM Status** screen to display the screen as shown next.

Figure 229 Advanced Application > OAM Status > OAM Details

OAM Details		OAM Status
Port No: 1		
Discovery	Local Client	OAM configurations
	Mode	
	Unidirectional	
	Remote loopback	
	Link events	
	Variable retrieval	
	Max. OAMPDU size	
	Local Client	Operational status
	Link status	
	Info. revision	
	Parser state	
	Discovery state	
	Remote Client	
	MAC address	
	Vendor(oui)	
	Remote Client	OAM configurations
	Mode	
	Unidirectional	
	Remote loopback	
	Link events	
	Variable retrieval	
	Max OAMPDU size	
	Remote Client	Operational status
	Info revision	
Statistics		
	Information OAMPDU Tx	
	Information OAMPDU Rx	
	Event Notification OAMPDU Tx	
	Event Notification OAMPDU Rx	
	Loopback Control OAMPDU Tx	
	Loopback Control OAMPDU Rx	
	Variable Request OAMPDU Tx	
	Variable Request OAMPDU Rx	
	Variable Response OAMPDU Tx	
	Variable Response OAMPDU Rx	
	Unsupported OAMPDU Tx	
	Unsupported OAMPDU Rx	

The following table describes the fields in the above screen.

Table 150 Advanced Application > OAM Status > OAM Details

LABEL	DESCRIPTION
Discovery	This section displays OAM configuration details and operational status of the port on the Switch and/or the remote device.
Local Client/Remote Client	
OAM configurations	
Mode	<p>This field displays the OAM mode. The device in active mode (typically the service provider's device) controls the device in passive mode (typically the subscriber's device).</p> <p>Active: The port initiates OAM discovery; sends information PDUs; and may send event notification PDUs, variable request/response PDUs, or loopback control PDUs.</p> <p>Passive: The port waits for the remote device to initiate OAM discovery; sends information PDUs; may send event notification PDUs; and may respond to variable request PDUs or loopback control PDUs.</p> <p>The Switch might not support some types of PDUs, as indicated in the fields below.</p>

Table 150 Advanced Application > OAM Status > OAM Details (continued)

LABEL	DESCRIPTION
Unidirectional	This field indicates whether or not the port can send information PDUs to transmit fault information when the receive path is non-operational.
Remote loopback	This field indicates whether or not the port can use loopback control PDUs to put the remote device into loopback mode.
Link events	This field indicates whether or not the port can interpret link events, such as link fault and dying gasp. Link events are sent in event notification PDUs and indicate when the number of errors in a given interval (time, number of frames, number of symbols, or number of error frame seconds) exceeds a specified threshold. Organizations may create organization-specific link event TLVs as well.
Variable retrieval	This field indicates whether or not the port can respond to requests for more information, such as requests for Ethernet counters and statistics, about link events.
Max. OAMPDU size	This field displays the maximum size of PDU for receipt and delivery.
Local Client/Remote Client	
Operational status	
Link status	This field indicates that the link between the Switch port and a connected IEEE 802.3ah-enabled remote Ethernet device is up or down.
Info. revision	This field displays the current version of local state and configuration. This two-octet value starts at zero and increments every time the local state or configuration changes.
Parser state	<p>This field indicates the current state of the parser.</p> <p>Forward: The port is forwarding packets normally.</p> <p>Loopback: The port is in loopback mode.</p> <p>Discard: The port is discarding non-OAM PDUs because it is trying to or has put the remote device into loopback mode.</p>
Discovery state	<p>This field indicates the state in the OAM discovery process. OAM-enabled devices use this process to detect each other and to exchange information about their OAM configuration and capabilities. OAM discovery is a handshake protocol.</p> <p>Fault: One of the devices is transmitting OAM PDUs with link fault information, or the interface is not operational.</p> <p>Active Send Local: The port is in active mode and is trying to see if the remote device supports OAM.</p> <p>Passive Wait: The port is in passive mode and is waiting for the remote device to begin OAM discovery.</p> <p>Send Local Remote: This state occurs in the following circumstances.</p> <ul style="list-style-type: none"> • The port has discovered the remote device but has not accepted or rejected the connection yet. • The port has discovered the remote device and rejected the connection. <p>Send Local Remote OK: The port has discovered the remote device and has accepted the connection. In addition, the remote device has not accepted or rejected the connection yet, or the remote device has rejected the connected.</p> <p>Send Any: The port and the remote device have accepted the connection. This is the operating state for OAM links that are fully operational.</p>
Remote Client	
MAC Address	This field displays the MAC address of the IEEE 802.3ah-enabled remote Ethernet device that is connected to the Switch.
Vendor(oui)	This field displays the Organizationally Unique Identifiers (OUI) representing the vendor of the IEEE 802.3ah-enabled remote Ethernet device that is connected to the Switch.

Table 150 Advanced Application > OAM Status > OAM Details (continued)

LABEL	DESCRIPTION
Statistics	
This section displays the number of OAM packets transferred on the port of the Switch.	
Information OAMPDU Tx	This field displays the number of OAM PDUs sent on the port.
Information OAMPDU Rx	This field displays the number of OAM PDUs received on the port.
Event Notification OAMPDU Tx	This field displays the number of unique or duplicate OAM event notification PDUs sent on the port.
Event Notification OAMPDU Rx	This field displays the number of unique or duplicate OAM event notification PDUs received on the port.
Loopback Control OAMPDU Tx	This field displays the number of loopback control OAM PDUs sent on the port.
Loopback Control OAMPDU Rx	This field displays the number of loopback control OAM PDUs received on the port.
Variable Request OAMPDU Tx	This field displays the number of OAM PDUs sent to request MIB objects on the remote device.
Variable Request OAMPDU Rx	This field displays the number of OAM PDUs received requesting MIB objects on the Switch.
Variable Response OAMPDU Tx	This field displays the number of OAM PDUs sent by the Switch in response to requests.
Variable Response OAMPDU Rx	This field displays the number of OAM PDUs sent by the remote device in response to requests.
Unsupported OAMPDU Tx	This field displays the number of unsupported OAM PDUs sent on the port.
Unsupported OAMPDU Rx	This field displays the number of unsupported OAM PDUs received on the port.

36.3 OAM Configuration

Use this screen to turn on Ethernet OAM on the Switch and ports and configure the related settings.

In the **OAM Status** screen click **Configuration** to display the configuration screen as shown.

Figure 230 Advanced Application > OAM > OAM Configuration

Port	Active	Mode	Remote Loopback Supported	Remote Loopback Ignore-Rx
*	<input type="checkbox"/>	Active ▾	<input type="checkbox"/>	<input type="checkbox"/>
1	<input type="checkbox"/>	Active ▾	<input type="checkbox"/>	<input type="checkbox"/>
2	<input type="checkbox"/>	Active ▾	<input type="checkbox"/>	<input type="checkbox"/>
3	<input type="checkbox"/>	Active ▾	<input type="checkbox"/>	<input type="checkbox"/>
4	<input type="checkbox"/>	Active ▾	<input type="checkbox"/>	<input type="checkbox"/>
5	<input type="checkbox"/>	Active ▾	<input type="checkbox"/>	<input type="checkbox"/>
6	<input type="checkbox"/>	Active ▾	<input type="checkbox"/>	<input type="checkbox"/>
7	<input type="checkbox"/>	Active ▾	<input type="checkbox"/>	<input type="checkbox"/>
8	<input type="checkbox"/>	Active ▾	<input type="checkbox"/>	<input type="checkbox"/>
9	<input type="checkbox"/>	Active ▾	<input type="checkbox"/>	<input type="checkbox"/>

The following table describes the fields in the above screen.

Table 151 Advanced Application > OAM > OAM Configuration

LABEL	DESCRIPTION
Active	Select this option to enable Ethernet OAM on the Switch.
Port	This field displays the port number.
*	Settings in this row apply to all ports. Use this row only if you want to make some settings the same for all ports. Use this row first to set the common settings and then make adjustments on a port-by-port basis. Note: Changes in this row are copied to all the ports as soon as you make them.
Active	Select this check box to enable Ethernet OAM on this port. Clear this check box to disable Ethernet OAM on the port.
Mode	Specify the OAM mode on the port. Select Active to allow the port to issue and respond to Ethernet OAM commands. Select Passive to allow the port to respond to Ethernet OAM commands.
Remote Loopback Supported	Select this check box to enable the remote loopback feature on the port. Otherwise, clear the check box to disable it.
Remote Loopback Ignore-Rx	Select this check box to set the Switch to process loopback commands received on the port. Otherwise, clear the check box to have the Switch ignore loopback commands received on the port.
Apply	Click Apply to save your changes to the Switch's run-time memory. The Switch loses these changes if it is turned off or loses power, so use the Save link on the top navigation panel to save your changes to the non-volatile memory when you are done configuring.
Cancel	Click Cancel to begin configuring this screen afresh.

36.4 OAM Remote Loopback

Use this screen to perform a remote loopback test. In the **OAM Status** screen click **Remote Loopback** to display the screen as shown.

Figure 231 Advanced Application > OAM > OAM Remote Loopback

The following table describes the fields in the above screen.

Table 152 Advanced Application > OAM > OAM Remote Loopback

LABEL	DESCRIPTION
Remote Loopback Test	
Port	Enter the number of the port from which the Switch performs a remote-loopback test.
Number of Packet	Define the allowable packet number of the loopback test frames.
Packet Size	Define the allowable packet size of the loopback test frames.
Test	Click Test to begin the test.
Remote Loopback Mode	
Port	Enter the number of the port from which the Switch sends loopback control PDUs to initiate or terminate a remote-loopback test.
Start	Click Start to initiate a remote-loopback test from the specified port by sending Enable Loopback Control PDUs to the remote device.
Stop	Click Stop to terminate a remote-loopback test from the specified port by sending Disable Loopback Control PDUs to the remote device.

CHAPTER 37

Static Route

37.1 Static Routing Overview

This chapter shows you how to configure static routes.

The Switch uses IP for communication with management computers, for example using HTTP, Telnet, SSH, or SNMP. Use IP static routes to have the Switch respond to remote management stations that are not reachable through the default gateway. The Switch can also use static routes to send data to a server or device that is not reachable through the default gateway, for example when sending SNMP traps or using ping to test IP connectivity.

This figure shows a **Telnet** session coming in from network **N1**. The Switch sends reply traffic to default gateway **R1** which routes it back to the manager's computer. The Switch needs a static route to tell it to use router **R2** to send traffic to an SNMP trap server on network **N2**.

Figure 232 Static Routing Overview

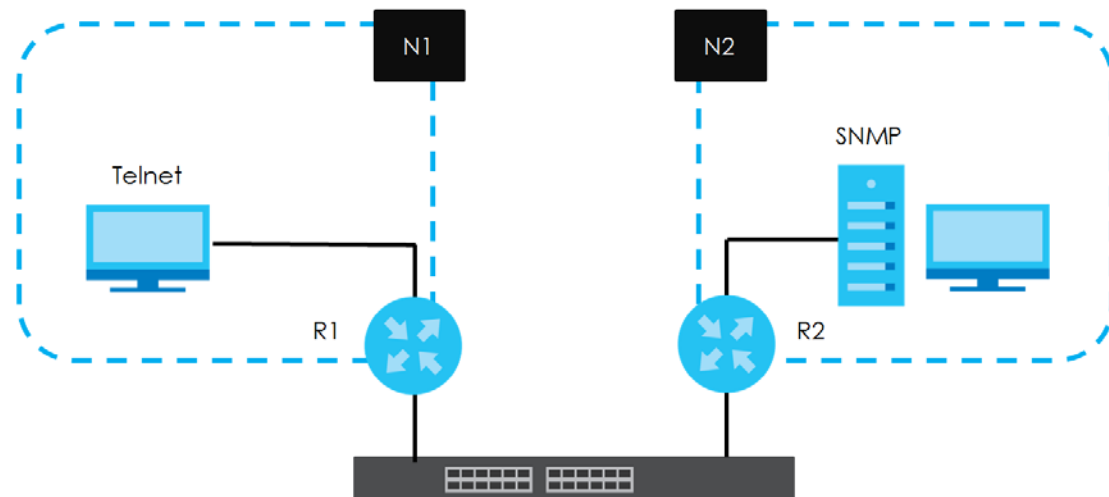

37.1.1 What You Can Do

- Use the **Static Routing** screen ([Section 37.2 on page 320](#)) to display the link to the **IPv4 Static Route** screen.
- Use the **IPv4 Static Route** screen ([Section 37.3 on page 321](#)) to configure and enable an IPv4 static route.

37.2 Static Routing

Click **IP Application > Static Routing** in the navigation panel to display the screen as shown.

Click the link next to **IPv4 Static Route** to open a screen where you can create IPv4 static routing rules.

Figure 233 IP Application > Static Routing



37.3 IPv4 Static Route

Click the link next to **IPv4 Static Route** in the **IP Application > Static Routing** screen to display the screen as shown.

Figure 234 IP Application > Static Routing > IPv4 Static Route

The following table describes the related labels you use to create a static route.

Table 153 IP Application > Static Routing > IPv4 Static Route

LABEL	DESCRIPTION
Active	This field allows you to activate or deactivate this static route.
Name	Enter a descriptive name (up to 10 printable ASCII characters) for identification purposes.
Destination IP Address	This parameter specifies the IP network address of the final destination.
IP Subnet Mask	Enter the subnet mask for this destination. Routing is always based on network number. If you need to specify a route to a single host, use a subnet mask of 255.255.255.255 in the subnet mask field to force the network number to be identical to the host ID.
Gateway IP Address	Enter the IP address of the gateway. The gateway is an immediate neighbor of your Switch that will forward the packet to the destination. The gateway must be a router on the same segment as your Switch.
Metric	The metric represents the "cost" of transmission for routing purposes. IP routing uses hop count as the measurement of cost, with a minimum of 1 for directly connected networks. Enter a number that approximates the cost for this link. The number need not be precise, but it must be between 1 and 15. In practice, 2 or 3 is usually a good number.
Add	Click Add to insert a new static route to the Switch's run-time memory. The Switch loses these changes if it is turned off or loses power, so use the Save link on the top navigation panel to save your changes to the non-volatile memory when you are done configuring.
Cancel	Click Cancel to reset the above fields to your previous configuration.
Clear	Click Clear to set the above fields back to the factory defaults.

Table 153 IP Application > Static Routing > IPv4 Static Route (continued)

LABEL	DESCRIPTION
Index	This field displays the index number of the route. Click a number to edit the static route entry.
Active	This field displays Yes when the static route is activated and NO when it is deactivated.
Name	This field displays the descriptive name for this route. This is for identification purposes only.
Destination Address	This field displays the IP network address of the final destination.
Subnet Mask	This field displays the subnet mask for this destination.
Gateway Address	This field displays the IP address of the gateway. The gateway is an immediate neighbor of your Switch that will forward the packet to the destination.
Metric	This field displays the cost of transmission for routing purposes.
	Select an entry's check box to select a specific entry. Otherwise, select the check box in the table heading row to select all entries.
Delete	Click Delete to remove the selected entry from the summary table.
Cancel	Click Cancel to clear the check boxes.

The following table describes some common output fields.

Table 154 IP Application > IPv6 OSPF > OSPF Status: Common Output Fields

FIELD	DESCRIPTION
Interface	
Interface ID	This field displays the ID number of the IPv6 interface.
Internet Address	This field displays the IPv6 link-local/global addresses and prefix length for the IPv6 interface.
Neighbor	
Neighbor ID	This field displays the router ID of the neighbor.
Pri	This field displays the priority of the neighbor. This number is used in the designated router election.
Dead Time	This field displays the dead time in seconds the Switch waits for a hello packet from the interface's neighbor device before declaring that the neighbor device is not available. The default value is 40 seconds.
State/IfState	This field displays the state of the neighbor (Init , ExStart , Exchange or Full) and whether the neighbor interface is acting as a DR (designated router), BDR (backup designated router) or DRother .
Duration	This field displays how long a relationship between the neighbor and the Switch IPv6 interface has been established to exchange routing information.
I/F [State]	This field displays the name of the Switch IPv6 interface and whether it is a (DR (designated router), BDR (backup designated router) or DRother).
Link State Database	
Type	This field displays the type of the LSA. <ul style="list-style-type: none"> • Type 1: Router LSA • Type 2: Network LSA • Type 3: Inter-Area Prefix LSA • Type 4: Inter-Area Router LSA • Type 5: AS-External LSA • Type 6: Group Membership LSA • Type 7: NSSA LSA • Type 8: Link LSA • Type 9: Intra-area Prefix LSA
LSId	This field displays the link state ID to identify what is advertised by the LSA.
Adv Router	This field displays the router ID of the layer-3 device that sends the LSAs.
Age	This field displays the time (in seconds) since the last LSA was sent.
Seq Num	This field displays the link sequence number of the LSA.
Checksum	This field displays the checksum value of the LSA.
Link Count	This field displays the number of links in the LSA.
Payload	This field displays the router ID for LSA type 1 or 2, the next-hop router address for LSA type 8, and the IPv6 prefix of the route entry for other LSA types.

CHAPTER 38

Differentiated Services

38.1 DiffServ Overview

This chapter shows you how to configure Differentiated Services (DiffServ) on the Switch.

Quality of Service (QoS) is used to prioritize source-to-destination traffic flows. All packets in the flow are given the same priority. You can use CoS (class of service) to give different priorities to different packet types.

DiffServ is a class of service (CoS) model that marks packets so that they receive specific per-hop treatment at DiffServ-compliant network devices along the route based on the application types and traffic flow. Packets are marked with DiffServ Code Points (DSCPs) indicating the level of service desired. This allows the intermediary DiffServ-compliant network devices to handle the packets differently depending on the code points without the need to negotiate paths or remember state information for every flow. In addition, applications do not have to request a particular service or give advanced notice of where the traffic is going.

38.1.1 What You Can Do

- Use the **DiffServ** screen ([Section 38.2 on page 325](#)) to activate DiffServ to apply marking rules or IEEE 802.1p priority mapping on the Switch.
- Use the **DSCP Setting** screen ([Section 38.3.1 on page 326](#)) to change the DSCP-IEEE 802.1p mapping.

38.1.2 What You Need to Know

Read on for concepts on Differentiated Services that can help you configure the screens in this chapter.

DSCP and Per-Hop Behavior

DiffServ defines a new DS (Differentiated Services) field to replace the Type of Service (ToS) field in the IP header. The DS field contains a 6-bit DSCP field which can define up to 64 service levels and the remaining 2 bits are defined as currently unused (CU). The following figure illustrates the DS field.

Figure 235 DiffServ: Differentiated Service Field

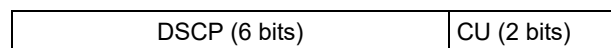

DSCP is backward compatible with the three precedence bits in the ToS octet so that non-DiffServ compliant, ToS-enabled network device will not conflict with the DSCP mapping.

The DSCP value determines the PHB (Per-Hop Behavior), that each packet gets as it is forwarded across the DiffServ network. Based on the marking rule different kinds of traffic can be marked for different priorities of forwarding. Resources can then be allocated according to the DSCP values and the configured policies.

DiffServ Network Example

The following figure depicts a DiffServ network consisting of a group of directly connected DiffServ-compliant network devices. The boundary node (**A** in Figure 236) in a DiffServ network classifies (marks with a DSCP value) the incoming packets into different traffic flows (**Platinum, Gold, Silver, Bronze**) based on the configured marking rules. A network administrator can then apply various traffic policies to the traffic flows. An example traffic policy, is to give higher drop precedence to one traffic flow over others. In our example, packets in the **Bronze** traffic flow are more likely to be dropped when congestion occurs than the packets in the **Platinum** traffic flow as they move across the DiffServ network.

Figure 236 DiffServ Network

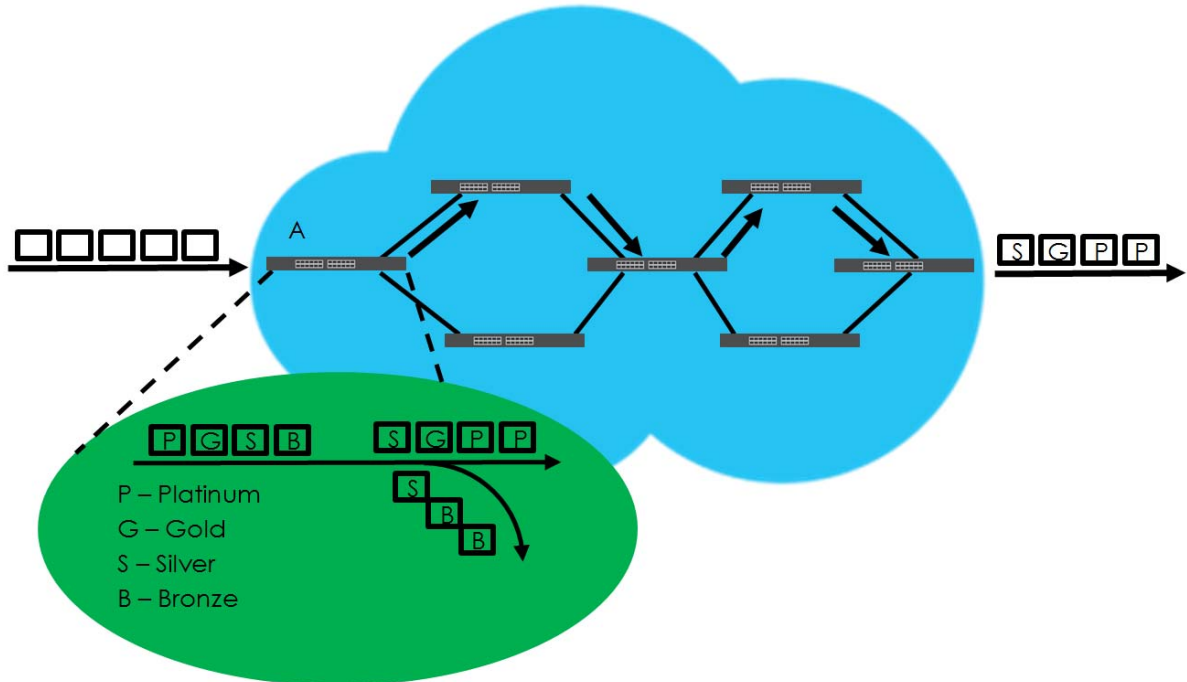

38.2 Activating DiffServ

Activate DiffServ to apply marking rules or IEEE 802.1p priority mapping on the selected ports.

Click **IP Application** > **DiffServ** in the navigation panel to display the screen as shown.

Figure 237 IP Application > DiffServ

Port	Active
*	<input type="checkbox"/>
1	<input type="checkbox"/>
2	<input type="checkbox"/>
3	<input type="checkbox"/>
4	<input type="checkbox"/>
5	<input type="checkbox"/>
6	<input type="checkbox"/>
7	<input type="checkbox"/>
8	<input type="checkbox"/>
9	<input type="checkbox"/>

The following table describes the labels in this screen.

Table 155 IP Application > DiffServ

LABEL	DESCRIPTION
Active	Select this option to enable DiffServ on the Switch.
Port	This field displays the index number of a port on the Switch.
*	Settings in this row apply to all ports. Use this row only if you want to make some settings the same for all ports. Use this row first to set the common settings and then make adjustments on a port-by-port basis. Changes in this row are copied to all the ports as soon as you make them.
Active	Select Active to enable Diffserv on the port.
Apply	Click Apply to save your changes to the Switch's run-time memory. The Switch loses these changes if it is turned off or loses power, so use the Save link on the top navigation panel to save your changes to the non-volatile memory when you are done configuring.
Cancel	Click Cancel to begin configuring this screen afresh.

38.3 DSCP-to-IEEE 802.1p Priority Settings

You can configure the DSCP to IEEE 802.1p mapping to allow the Switch to prioritize all traffic based on the incoming DSCP value according to the DiffServ to IEEE 802.1p mapping table.

The following table shows the default DSCP-to-IEEE802.1p mapping.

Table 156 Default DSCP-IEEE 802.1p Mapping

DSCP VALUE	0 – 7	8 – 15	16 – 23	24 – 31	32 – 39	40 – 47	48 – 55	56 – 63
IEEE 802.1p	0	1	2	3	4	5	6	7

38.3.1 Configuring DSCP Settings

To change the DSCP-IEEE 802.1p mapping click the **DSCP Setting** link in the **DiffServ** screen to display the screen as shown next.

Figure 238 IP Application > DiffServ > DSCP Setting

DSCP Setting													Diffserv		
DSCP to 802.1p Mapping															
0	0 ▾	1	0 ▾	2	0 ▾	3	0 ▾	4	0 ▾	5	0 ▾	6	0 ▾	7	0 ▾
8	1 ▾	9	1 ▾	10	1 ▾	11	1 ▾	12	1 ▾	13	1 ▾	14	1 ▾	15	1 ▾
16	2 ▾	17	2 ▾	18	2 ▾	19	2 ▾	20	2 ▾	21	2 ▾	22	2 ▾	23	2 ▾
24	3 ▾	25	3 ▾	26	3 ▾	27	3 ▾	28	3 ▾	29	3 ▾	30	3 ▾	31	3 ▾
32	4 ▾	33	4 ▾	34	4 ▾	35	4 ▾	36	4 ▾	37	4 ▾	38	4 ▾	39	4 ▾
40	5 ▾	41	5 ▾	42	5 ▾	43	5 ▾	44	5 ▾	45	5 ▾	46	5 ▾	47	5 ▾
48	6 ▾	49	6 ▾	50	6 ▾	51	6 ▾	52	6 ▾	53	6 ▾	54	6 ▾	55	6 ▾
56	7 ▾	57	7 ▾	58	7 ▾	59	7 ▾	60	7 ▾	61	7 ▾	62	7 ▾	63	7 ▾

[Apply](#) [Cancel](#)

The following table describes the labels in this screen.

Table 157 IP Application > DiffServ > DSCP Setting

LABEL	DESCRIPTION
0 ... 63	This is the DSCP classification identification number. To set the IEEE 802.1p priority mapping, select the priority level from the drop-down list box.
Apply	Click Apply to save your changes to the Switch's run-time memory. The Switch loses these changes if it is turned off or loses power, so use the Save link on the top navigation panel to save your changes to the non-volatile memory when you are done configuring.
Cancel	Click Cancel to begin configuring this screen afresh.

CHAPTER 39

DHCP

39.1 DHCP Overview

This chapter shows you how to configure the DHCP feature.

DHCP (Dynamic Host Configuration Protocol RFC 2131 and RFC 2132) allows individual computers to obtain TCP/IP configuration at start-up from a server. If you configure the Switch as a DHCP relay agent, then the Switch forwards DHCP requests to DHCP server on your network. If you do not configure the Switch as a DHCP relay agent then you must have a DHCP server in the broadcast domain of the client computers or else the client computers must be configured manually.

39.1.1 What You Can Do

- Use the **DHCPv4 Status** screen ([Section 39.3 on page 329](#)) to display the relay mode.
- Use the **DHCPv4 Option 82 Profile** screen ([Section 39.4.2 on page 331](#)) to create DHCPv4 option 82 profiles.
- Use the **DHCPv4 Global Relay** screen ([Section 39.4.3 on page 332](#)) to configure global DHCPv4 relay.
- Use the **DHCPv4 Global Relay Port** screen ([Section 39.4.4 on page 333](#)) to apply a different DHCP option 82 profile to certain ports on the Switch.
- Use the **VLAN Setting** screen ([Section 39.4.6 on page 335](#)) to configure your DHCPv4 settings based on the VLAN domain of the DHCPv4 clients.
- Use the **DHCPv4 VLAN Port** screen ([Section 39.4.7 on page 336](#)) to apply a different DHCP option 82 profile to certain ports in a VLAN.
- Use the **DHCPv6 Relay** screen ([Section 39.5 on page 338](#)) to enable and configure DHCPv6 relay.

39.1.2 What You Need to Know

Read on for concepts on DHCP that can help you configure the screens in this chapter.

DHCP Modes

If there is already a DHCP server on your network, then you can configure the Switch as a DHCP relay agent. When the Switch receives a request from a computer on your network, it contacts the DHCP server for the necessary IP information, and then relays the assigned information back to the computer.

DHCPv4 Configuration Options

The DHCPv4 configuration on the Switch is divided into **Global** and **VLAN** screens. The screen you should use for configuration depends on the DHCP services you want to offer the DHCP clients on your network. Choose the configuration screen based on the following criteria:

- **Global** – The Switch forwards all DHCP requests to the same DHCP server.
- **VLAN** – The Switch is configured on a VLAN by VLAN basis. The Switch can be configured to relay DHCP requests to different DHCP servers for clients in different VLAN.

39.2 DHCP Configuration

Click **IP Application > DHCP** in the navigation panel to display the screen as shown. Click the link next to **DHCPv4** to open screens where you can enable and configure DHCPv4 relay settings and create option 82 profiles. Click the link next to **DHCPv6** to open a screen where you can configure DHCPv6 relay settings.

Figure 239 IP Application > DHCP



39.3 DHCPv4 Status

Click **IP Application > DHCP > DHCPv4** in the navigation panel. The **DHCP Status** screen displays.

Figure 240 IP Application > DHCP > DHCPv4

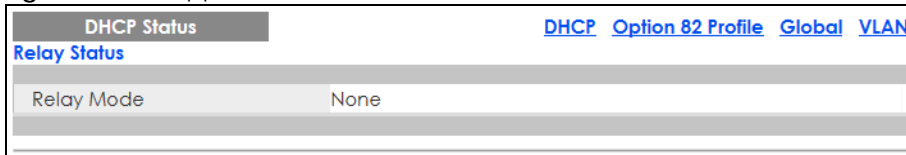

The following table describes the labels in this screen.

Table 158 IP Application > DHCP > DHCPv4

LABEL	DESCRIPTION
Relay Status	This section displays configuration settings related to the Switch's DHCP relay mode.
Relay Mode	This field displays: <ul style="list-style-type: none"> None – if the Switch is not configured as a DHCP relay agent. Global – if the Switch is configured as a DHCP relay agent only. VLAN – followed by a VLAN ID or multiple VLAN IDs if it is configured as a relay agent for specific VLANs.

39.4 DHCPv4 Relay

Configure DHCP relay on the Switch if the DHCP clients and the DHCP server are not in the same broadcast domain. During the initial IP address leasing, the Switch helps to relay network information (such as the IP address and subnet mask) between a DHCP client and a DHCP server. Once the DHCP

client obtains an IP address and can connect to the network, network information renewal is done between the DHCP client and the DHCP server without the help of the Switch.

The Switch can be configured as a global DHCP relay. This means that the Switch forwards all DHCP requests from all domains to the same DHCP server. You can also configure the Switch to relay DHCP information based on the VLAN membership of the DHCP clients.

39.4.1 DHCPv4 Relay Agent Information

The Switch can add information about the source of client DHCP requests that it relays to a DHCP server by adding **Relay Agent Information**. This helps provide authentication about the source of the requests. The DHCP server can then provide an IP address based on this information. Please refer to RFC 3046 for more details.

The DHCP **Relay Agent Information** feature adds an Agent Information field (also known as the **Option 82** field) to DHCP requests. The **Option 82** field is in the DHCP headers of client DHCP request frames that the Switch relays to a DHCP server.

Relay Agent Information can include the **System Name** of the Switch if you select this option. You can change the **System Name** in **Basic Setting > General Setup**.

The following describes the DHCP relay agent information that the Switch sends to the DHCP server:

Table 159 Relay Agent Information

FIELD LABELS	DESCRIPTION
Slot ID	(1 byte) This value is always 0 for stand-alone switches.
Port ID	(1 byte) This is the port that the DHCP client is connected to.
VLAN ID	(2 bytes) This is the VLAN that the port belongs to.
Information	(up to 64 bytes) This optional, read-only field is set according to system name set in Basic Setting > General Setup .

39.4.1.1 DHCPv4 Relay Agent Information Format

A DHCP Relay Agent Information option has the following format.

Table 160 DHCP Relay Agent Information Option Format



i1, i2 and iN are DHCP relay agent sub-options, which contain additional information about the DHCP client. You need to define at least one sub-option.

39.4.1.2 Sub-Option Format

There are two types of sub-option: "Agent Circuit ID Sub-option" and "Agent Remote ID Sub-option". They have the following formats.

Table 161 DHCP Relay Agent Circuit ID Sub-option Format

SubOpt Code	Length	Value
1 (1 byte)	N (1 byte)	Slot ID, Port ID, VLAN ID, System Name or String

Table 162 DHCP Relay Agent Remote ID Sub-option Format

SubOpt Code	Length	Value
2 (1 byte)	N (1 byte)	MAC Address or String

The 1 in the first field identifies this as an Agent Circuit ID sub-option and two identifies this as an Agent Remote ID sub-option. The next field specifies the length of the field.

39.4.2 DHCPv4 Option 82 Profile

Use this screen to create DHCPv4 option 82 profiles. Click **IP Application > DHCP > DHCPv4** in the navigation panel and click the **Option 82 Profile** link to display the screen as shown.

Figure 241 IP Application > DHCP > DHCPv4 > Option 82 Profile

Profile Name	Enable	Circuit-ID Field	Remote-ID Enable	Remote-ID Field	
default1	Yes	slot-port, vlan	No	-	<input type="checkbox"/>
default2	Yes	slot-port, vlan, hostname	No	-	<input type="checkbox"/>

The following table describes the labels in this screen.

Table 163 IP Application > DHCP > DHCPv4 > Option 82 Profile

LABEL	DESCRIPTION
Name	Enter a descriptive name for the profile for identification purposes. You can use up to 32 ASCII characters. Spaces are allowed.
Circuit-ID	Use this section to configure the Circuit ID sub-option to include information that is specific to the relay agent (the Switch).
Enable	Select this option to have the Switch add the Circuit ID sub-option to client DHCP requests that it relays to a DHCP server.
slot-port	Select this option to have the Switch add the number of port that the DHCP client is connected to.
vlan	Select this option to have the Switch add the ID of VLAN which the port belongs to.
hostname	This is the system name you configure in the Basic Setting > General Setup screen. Select this option for the Switch to add the system name to the client DHCP requests that it relays to a DHCP server.

Table 163 IP Application > DHCP > DHCPv4 > Option 82 Profile (continued)

LABEL	DESCRIPTION
string	Enter a string of up to 64 ASCII characters that the Switch adds into the client DHCP requests. Spaces are allowed.
Remote-ID	Use this section to configure the Remote ID sub-option to include information that identifies the relay agent (the Switch).
Enable	Select this option to have the Switch append the Remote ID sub-option to the option 82 field of DHCP requests.
mac	Select this option to have the Switch add its MAC address to the client DHCP requests that it relays to a DHCP server.
string	Enter a string of up to 64 ASCII characters for the remote ID information in this field. Spaces are allowed.
Add	Click this to create a new entry or to update an existing one. This saves your changes to the Switch's run-time memory. The Switch loses these changes if it is turned off or loses power, so use the Save link on the top navigation panel to save your changes to the non-volatile memory when you are done configuring.
Cancel	Click Cancel to reset the fields to their last saved values.
Profile Name	This field displays the descriptive name of the profile. Click the name to change the settings.
Circuit-ID	This section displays the Circuit ID sub-option including information that is specific to the relay agent (the Switch).
Enable	This field displays whether the Circuit ID sub-option is added to client DHCP requests.
Field	This field displays the information that is included in the Circuit ID sub-option.
Remote-ID	This section displays the Remote ID sub-option including information that identifies the relay agent (the Switch).
Enable	This field displays whether the Remote ID sub-option is added to client DHCP requests.
Field	This field displays the information that is included in the Remote ID sub-option.
	Select an entry's check box to select a specific entry. Otherwise, select the check box in the table heading row to select all entries.
Delete	Check the entries that you want to remove and then click the Delete button.
Cancel	Click Cancel to clear the selected check boxes.

39.4.3 Configuring DHCPv4 Global Relay

Use this screen to configure global DHCPv4 relay. Click **IP Application > DHCP > DHCPv4** in the navigation panel and click the **Global** link to display the screen as shown.

Figure 242 IP Application > DHCP > DHCPv4 > Global

DHCP Relay		Status Port
Active	<input type="checkbox"/>	
Remote DHCP Server 1	0.0.0.0	
Remote DHCP Server 2	0.0.0.0	
Remote DHCP Server 3	0.0.0.0	
Option 82 Profile		

The following table describes the labels in this screen.

Table 164 IP Application > DHCP > DHCPv4 > Global

LABEL	DESCRIPTION
Active	Select this check box to enable DHCPv4 relay.
Remote DHCP Server 1 .. 3	Enter the IP address of a DHCPv4 server in dotted decimal notation.
Option 82 Profile	Select a pre-defined DHCPv4 option 82 profile that the Switch applies to all ports. The Switch adds the Circuit ID sub-option and/or Remote ID sub-option specified in the profile to DHCP requests that it relays to a DHCP server.
Apply	Click Apply to save your changes to the Switch's run-time memory. The Switch loses these changes if it is turned off or loses power, so use the Save link on the top navigation panel to save your changes to the non-volatile memory when you are done configuring.
Cancel	Click Cancel to begin configuring this screen afresh.

39.4.4 Configure DHCPv4 Global Relay Port

Use this screen to apply a different DHCP option 82 profile to certain ports on the Switch. To open this screen, click **IP Application > DHCP > DHCPv4 > Global > Port**.

Figure 243 IP Application > DHCP > DHCPv4 > Global > Port

The following table describes the labels in this screen.

Table 165 IP Application > DHCP > DHCPv4 > Global > Port

LABEL	DESCRIPTION
Port	Enter the number of ports to which you want to apply the specified DHCP option 82 profile. You can enter multiple ports separated by (no space) comma (,) or hyphen (-). For example, enter "3-5" for ports 3, 4, and 5. Enter "3,5,7" for ports 3, 5, and 7.
Option 82 Profile	Select a pre-defined DHCP option 82 profile that the Switch applies to the specified ports. The Switch adds the Circuit ID sub-option and/or Remote ID sub-option specified in the profile to DHCP requests that it relays to a DHCP server. The profile you select here has priority over the one you select in the DHCP > DHCPv4 > Global screen.
Add	Click this to create a new entry or to update an existing one. This saves your changes to the Switch's run-time memory. The Switch loses these changes if it is turned off or loses power, so use the Save link on the top navigation panel to save your changes to the non-volatile memory when you are done configuring.

Table 165 IP Application > DHCP > DHCPv4 > Global > Port (continued)

LABEL	DESCRIPTION
Cancel	Click this to reset the values above based on the last selected entry or, if not applicable, to clear the fields above.
Clear	Click Clear to reset the fields to the factory defaults.
Index	This field displays a sequential number for each entry. Click an index number to change the settings.
Port	This field displays the ports to which the Switch applies the settings.
Profile Name	This field displays the DHCP option 82 profile that the Switch applies to the ports.
	Select an entry's check box to select a specific entry. Otherwise, select the check box in the table heading row to select all entries.
Delete	Select the entries that you want to remove, then click the Delete button to remove the selected entries from the table.
Cancel	Click this to clear the check boxes above.

39.4.5 Global DHCP Relay Configuration Example

The follow figure shows a network example where the Switch is used to relay DHCP requests for the **VLAN1** and **VLAN2** domains. There is only one DHCP server that services the DHCP clients in both domains.

Figure 244 Global DHCP Relay Network Example

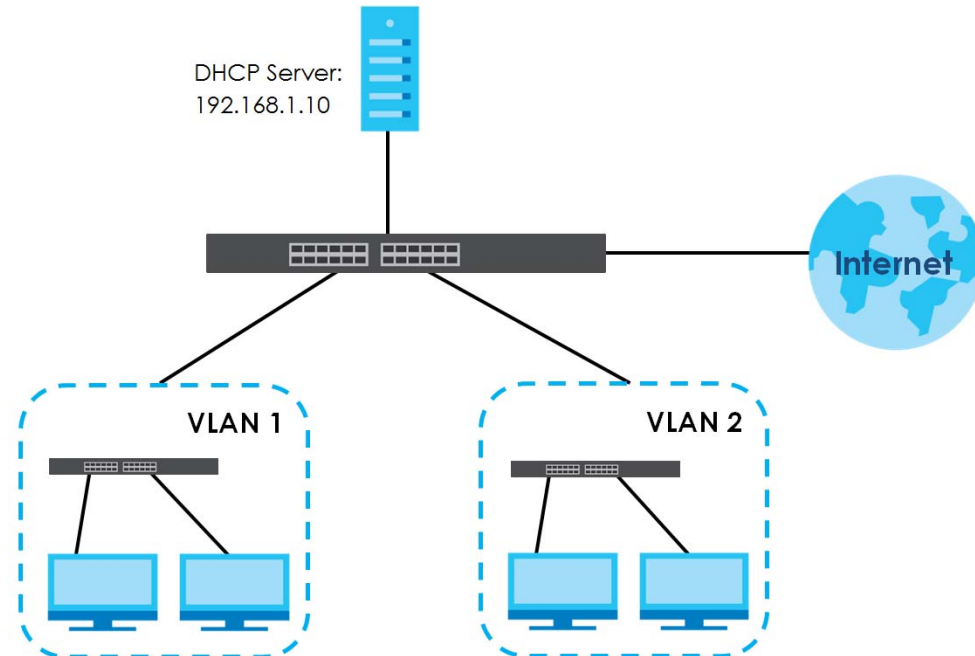

Configure the **DHCP Relay** screen as shown. Make sure you select a DHCP option 82 profile (**default1** in this example) to set the Switch to send additional information (such as the VLAN ID) together with the DHCP requests to the DHCP server. This allows the DHCP server to assign the appropriate IP address according to the VLAN ID.

Figure 245 DHCP Relay Configuration Example

DHCP Relay		Status	Port
Active	<input checked="" type="checkbox"/>		
Remote DHCP Server 1	192.168.1.100		
Remote DHCP Server 2	0.0.0.0		
Remote DHCP Server 3	0.0.0.0		
Option 82 Profile	default1 ▾		

EXAMPLE

[Apply](#) [Cancel](#)

39.4.6 DHCPv4 VLAN Setting

Use this screen to configure your DHCP settings based on the VLAN domain of the DHCP clients. Click **IP Application > DHCP > DHCPv4** in the navigation panel, then click the **VLAN** link in the **DHCP Status** screen that displays.

Note: You must set up a management IP address for each VLAN that you want to configure DHCP settings for on the Switch. See [Section 5.1.3 on page 63](#) for information on how to do this.

Figure 246 IP Application > DHCP > DHCPv4 > VLAN

VLAN Setting		Status	Port
VID	<input type="text"/>		
Relay			
Remote DHCP Server 1	0.0.0.0		
Remote DHCP Server 2	0.0.0.0		
Remote DHCP Server 3	0.0.0.0		
Option 82 Profile	▾		

[Add](#) [Cancel](#) [Clear](#)

VID	Type	DHCP Status	
			<input type="checkbox"/>

[Delete](#) [Cancel](#)

The following table describes the labels in this screen.

Table 166 IP Application > DHCP > DHCPv4 > VLAN

LABEL	DESCRIPTION
VID	Enter the ID number of the VLAN to which these DHCP settings apply.
Remote DHCP Server 1 .. 3	Enter the IP address of a DHCP server in dotted decimal notation.
Option 82 Profile	Select a pre-defined DHCP option 82 profile that the Switch applies to all ports in this VLAN. The Switch adds the Circuit ID sub-option and/or Remote ID sub-option specified in the profile to DHCP requests that it relays to a DHCP server.

Table 166 IP Application > DHCP > DHCPv4 > VLAN (continued)

LABEL	DESCRIPTION
Add	Click this to create a new entry or to update an existing one. This saves your changes to the Switch's run-time memory. The Switch loses these changes if it is turned off or loses power, so use the Save link on the top navigation panel to save your changes to the non-volatile memory when you are done configuring.
Cancel	Click Cancel to begin configuring this screen afresh.
Clear	Click Clear to reset the fields to the factory defaults.
VID	This field displays the ID number of the VLAN group to which this DHCP settings apply.
Type	This field displays Relay for the DHCP mode.
DHCP Status	For DHCP server configuration, this field displays the starting IP address and the size of the IP address pool. For DHCP relay configuration, this field displays the first remote DHCP server IP address.
	Select an entry's check box to select a specific entry. Otherwise, select the check box in the table heading row to select all entries.
Delete	Select the configuration entries you want to remove and click Delete to remove them.
Cancel	Click Cancel to clear the check boxes.

39.4.7 Configure DHCPv4 VLAN Port

Use this screen to apply a different DHCP option 82 profile to certain ports in a VLAN. To open this screen, click **IP Application > DHCP > DHCPv4 > VLAN > Port**.

Figure 247 IP Application > DHCP > DHCPv4 > VLAN > Port

The following table describes the labels in this screen.

Table 167 IP Application > DHCP > DHCPv4 > VLAN > Port

LABEL	DESCRIPTION
VID	Enter the ID number of the VLAN you want to configure here.
Port	Enter the number of ports to which you want to apply the specified DHCP option 82 profile. You can enter multiple ports separated by (no space) comma (,) or hyphen (-). For example, enter "3-5" for ports 3, 4, and 5. Enter "3,5,7" for ports 3, 5, and 7.
Option 82 Profile	Select a pre-defined DHCP option 82 profile that the Switch applies to the specified ports in this VLAN. The Switch adds the Circuit ID sub-option and/or Remote ID sub-option specified in the profile to DHCP requests that it relays to a DHCP server. The profile you select here has priority over the one you select in the DHCP > DHCPv4 > VLAN screen.

Table 167 IP Application > DHCP > DHCPv4 > VLAN > Port (continued)

LABEL	DESCRIPTION
Add	Click this to create a new entry or to update an existing one. This saves your changes to the Switch's run-time memory. The Switch loses these changes if it is turned off or loses power, so use the Save link on the top navigation panel to save your changes to the non-volatile memory when you are done configuring.
Cancel	Click this to reset the values above based on the last selected entry or, if not applicable, to clear the fields above.
Clear	Click Clear to reset the fields to the factory defaults.
Index	This field displays a sequential number for each entry. Click an index number to change the settings.
VID	This field displays the VLAN to which the ports belongs.
Port	This field displays the ports to which the Switch applies the settings.
Profile Name	This field displays the DHCP option 82 profile that the Switch applies to the ports in this VLAN.
	Select an entry's check box to select a specific entry. Otherwise, select the check box in the table heading row to select all entries.
Delete	Select the entries that you want to remove, then click the Delete button to remove the selected entries from the table.
Cancel	Click this to clear the check boxes above.

39.4.8 Example: DHCP Relay for Two VLANs

The following example displays two VLANs (VIDs 1 and 2) for a campus network. Two DHCP servers are installed to serve each VLAN. The system is set up to forward DHCP requests from the dormitory rooms (VLAN 1) to the DHCP server with an IP address of 192.168.1.100. Requests from the academic buildings (VLAN 2) are sent to the other DHCP server with an IP address of 172.16.10.100.

Figure 248 DHCP Relay for Two VLANs

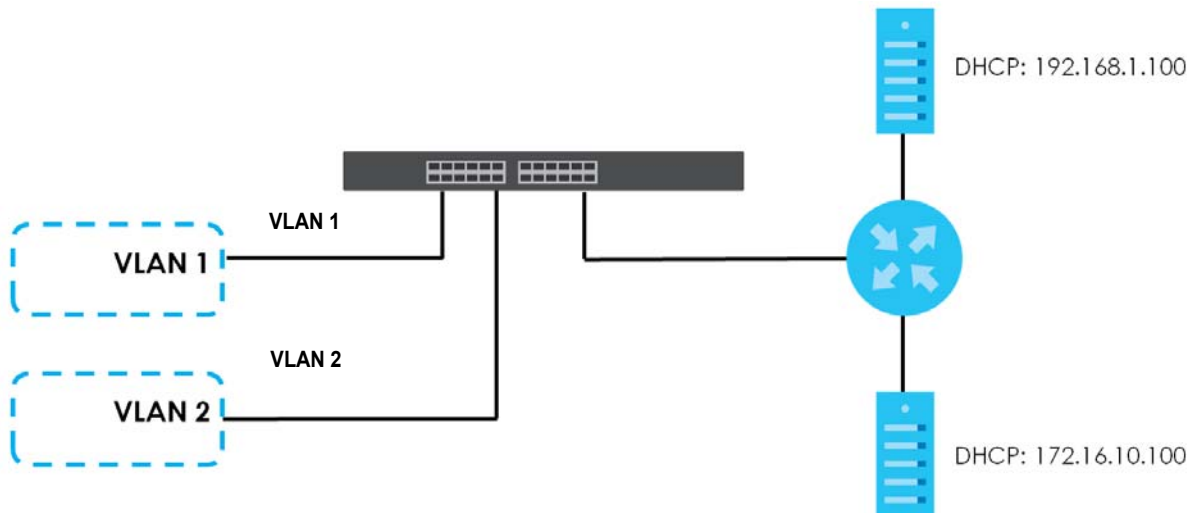

For the example network, configure the **VLAN Setting** screen as shown.

Figure 249 DHCP Relay for Two VLANs Configuration Example

The screenshot shows the DHCP Relay configuration interface. At the top, there is a 'VLAN Setting' section with a 'Status' and 'Port' link. Below this, there are several rows for configuration: 'Relay' (empty), 'Remote DHCP Server 1' (0.0.0.0), 'Remote DHCP Server 2' (0.0.0.0), 'Remote DHCP Server 3' (0.0.0.0), and 'Option 82 Profile' (dropdown menu). Below the configuration fields are 'Add', 'Cancel', and 'Clear' buttons. A red 'EXAMPLE' stamp is overlaid on the right side. Below the buttons is a table with columns 'VID', 'Type', and 'DHCP Status'. The table contains one row with VID '1', Type 'Relay', and DHCP Status '192.168.1.100'. Below the table are 'Delete' and 'Cancel' buttons.

VID	Type	DHCP Status
1	Relay	192.168.1.100

39.5 DHCPv6 Relay

A DHCPv6 relay agent is on the same network as the DHCPv6 clients and helps forward messages between the DHCPv6 server and clients. When a client cannot use its link-local address and a well-known multicast address to locate a DHCPv6 server on its network, it then needs a DHCPv6 relay agent to send a message to a DHCPv6 server that is not attached to the same network.

The DHCPv6 relay agent can add the remote identification (remote-ID) option and the interface-ID option to the Relay-Forward DHCPv6 messages. The remote-ID option carries a user-defined string, such as the system name. The interface-ID option provides slot number, port information and the VLAN ID to the DHCPv6 server. The remote-ID option (if any) is stripped from the Relay-Reply messages before the relay agent sends the packets to the clients. The DHCPv6 server copies the interface-ID option from the Relay-Forward message into the Relay-Reply message and sends it to the relay agent. The interface-ID should not change even after the relay agent restarts.

Use this screen to configure DHCPv6 relay settings for a specific VLAN on the Switch. Click **IP Application > DHCP > DHCPv6 > DHCPv6 Relay** in the navigation panel to display the screen as shown.

Figure 250 IP Application > DHCP > DHCPv6 Relay

The screenshot shows the DHCPv6 Relay configuration interface. It includes a title bar with 'DHCPv6 Relay' and a 'DHCP' link. The main area contains several input fields: 'VID', 'Helper Address', and 'Remote ID'. There is also a checkbox for 'Interface ID'. Below these fields are three buttons: 'Add', 'Cancel', and 'Clear'. At the bottom of the page, there is a table header with columns 'VID', 'Helper Address', 'Interface ID', and 'Remote ID', and a 'Delete' and 'Cancel' button below it.

The following table describes the labels in this screen.

Table 168 IP Application > DHCP > DHCPv6 Relay

LABEL	DESCRIPTION
VID	Enter the ID number of the VLAN you want to configure here.
Helper Address	Enter the remote DHCPv6 server address for the specified VLAN.
Options	
Interface ID	Select this option to have the Switch add the interface-ID option in the DHCPv6 requests from the clients in the specified VLAN before the Switch forwards them to a DHCPv6 server.
Remote ID	Enter a string of up to 64 printable characters to be carried in the remote-ID option. The Switch adds the remote-ID option in the DHCPv6 requests from the clients in the specified VLAN before the Switch forwards them to a DHCPv6 server.
Add	Click this to create a new entry or to update an existing one. This saves your changes to the Switch's run-time memory. The Switch loses these changes if it is turned off or loses power, so use the Save link on the top navigation panel to save your changes to the non-volatile memory when you are done configuring.
Cancel	Click Cancel to reset the fields to their last saved values.
Clear	Click Clear to reset the fields to the factory defaults.
VID	This field displays the VLAN ID number. Click the VLAN ID to change the settings.
Helper Address	This field displays the IPv6 address of the remote DHCPv6 server for this VLAN.
Interface ID	This field displays whether the interface-ID option is added to DHCPv6 requests from clients in this VLAN.
Remote ID	This field displays whether the remote-ID option is added to DHCPv6 requests from clients in this VLAN.
	Select an entry's check box to select a specific entry. Otherwise, select the check box in the table heading row to select all entries.
Delete	Check the entries that you want to remove and then click the Delete button.
Cancel	Click Cancel to clear the selected check boxes.

CHAPTER 40

ARP Setup

40.1 ARP Overview

Address Resolution Protocol (ARP) is a protocol for mapping an Internet Protocol address (IP address) to a physical machine address, also known as a Media Access Control or MAC address, on the local area network.

An IP (version 4) address is 32 bits long. In an Ethernet LAN, MAC addresses are 48 bits long. The ARP table maintains an association between each MAC address and its corresponding IP address.

40.1.1 What You Can Do

Use the **ARP Learning** screen ([Section 40.2.1 on page 342](#)) to configure ARP learning mode on a per-port basis.

40.1.2 What You Need to Know

Read on for concepts on ARP that can help you configure the screen in this chapter.

40.1.2.1 How ARP Works

When an incoming packet destined for a host device on a local area network arrives at the Switch, the Switch looks in the ARP Table and if it finds the address, it sends it to the device.

If no entry is found for the IP address, ARP broadcasts the request to all the devices on the LAN. The Switch fills in its own MAC and IP address in the sender address fields, and puts the known IP address of the target in the target IP address field. In addition, the Switch puts all ones in the target MAC field (FF.FF.FF.FF.FF.FF is the Ethernet broadcast address). The replying device (which is either the IP address of the device being sought or the router that knows the way) replaces the broadcast address with the target's MAC address, swaps the sender and target pairs, and unicasts the answer directly back to the requesting machine. ARP updates the ARP Table for future reference and then sends the packet to the MAC address that replied.

40.1.2.2 ARP Learning Mode

The Switch supports three ARP learning modes: ARP-Reply, Gratuitous-ARP, and ARP-Request.

ARP-Reply

The Switch in ARP-Reply learning mode updates the ARP table only with the ARP replies to the ARP requests sent by the Switch. This can help prevent ARP spoofing.

In the following example, the Switch does not have IP address and MAC address mapping information for hosts **A** and **B** in its ARP table, and host **A** wants to ping host **B**. Host **A** sends an ARP request to the Switch and then sends an ICMP request after getting the ARP reply from the Switch. The Switch finds no matched entry for host **B** in the ARP table and broadcasts the ARP request to all the devices on the LAN. When the Switch receives the ARP reply from host **B**, it updates its ARP table and also forwards host **A**'s ICMP request to host **B**. After the Switch gets the ICMP reply from host **B**, it sends out an ARP request to get host **A**'s MAC address and updates the ARP table with host **A**'s ARP reply. The Switch then can forward host **B**'s ICMP reply to host **A**.

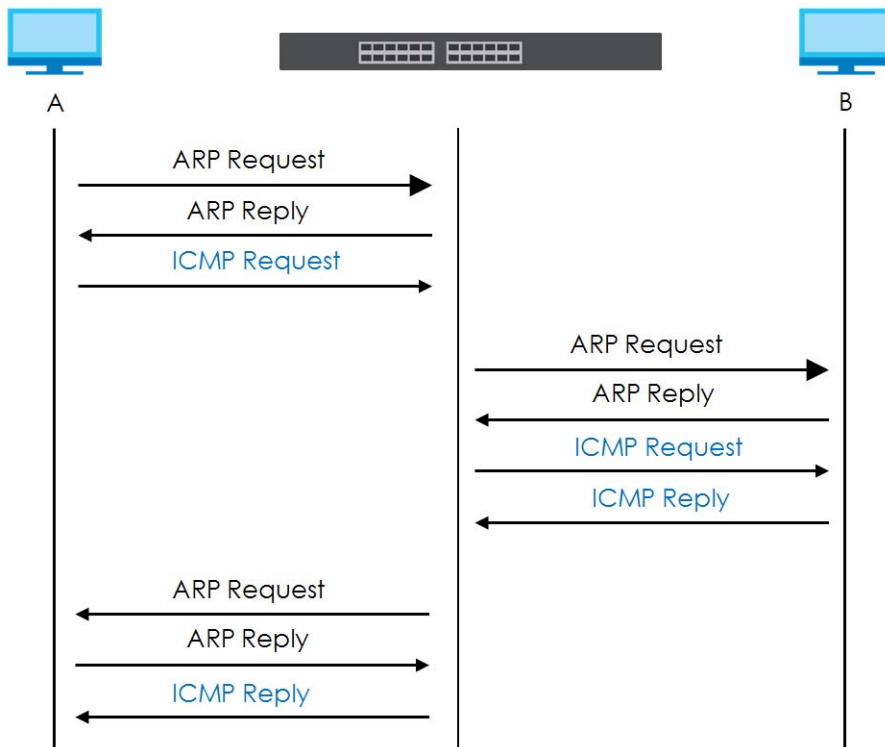

Gratuitous-ARP

A gratuitous ARP is an ARP request in which both the source and destination IP address fields are set to the IP address of the device that sends this request and the destination MAC address field is set to the broadcast address. There will be no reply to a gratuitous ARP request.

A device may send a gratuitous ARP packet to detect IP collisions. If a device restarts or its MAC address is changed, it can also use gratuitous ARP to inform other devices in the same network to update their ARP table with the new mapping information.

In Gratuitous-ARP learning mode, the Switch updates its ARP table with either an ARP reply or a gratuitous ARP request.

ARP-Request

When the Switch is in ARP-Request learning mode, it updates the ARP table with both ARP replies, gratuitous ARP requests and ARP requests.

Therefore in the following example, the Switch can learn host **A**'s MAC address from the ARP request sent by host **A**. The Switch then forwards host **B**'s ICMP reply to host **A** right after getting host **B**'s MAC

address and ICMP reply.

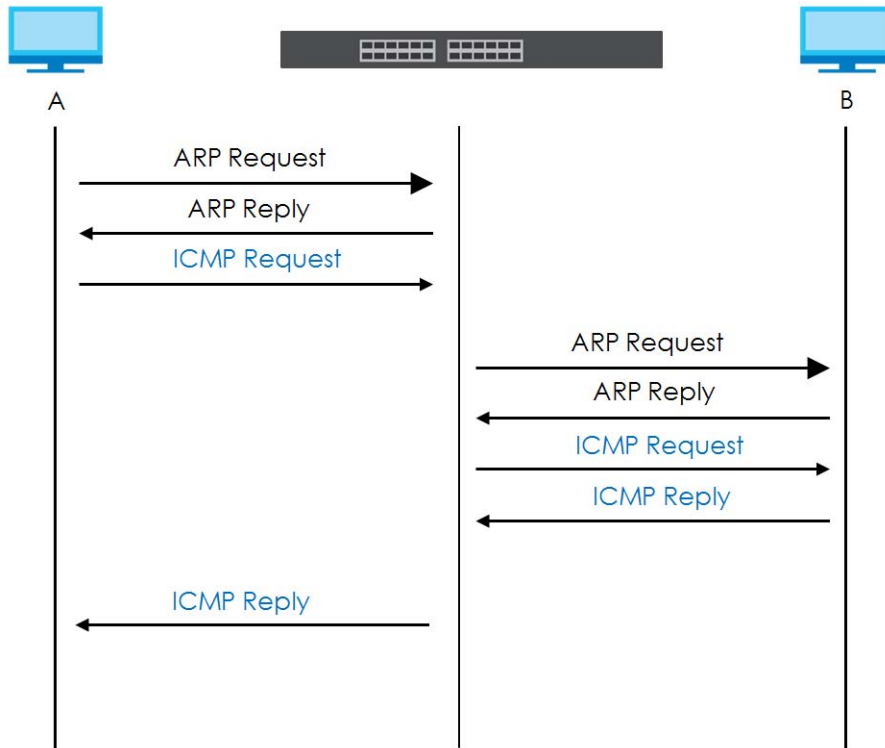

40.2 ARP Setup

Click **IP Application > ARP Setup** in the navigation panel to display the screen as shown. Click the link next to **ARP Learning** to open a screen where you can set the ARP learning mode for each port.

Figure 251 IP Application > ARP Setup

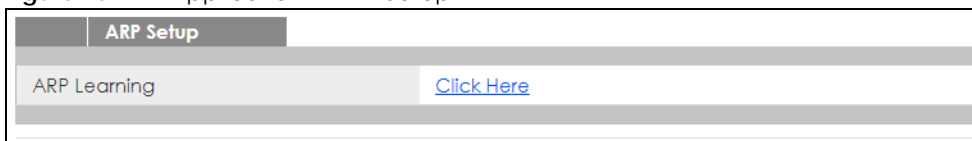

40.2.1 ARP Learning

Use this screen to configure each port's ARP learning mode. Click the link next to **ARP Learning** in the **IP Application > ARP Setup** screen to display the screen as shown next.

Figure 252 IP Application > ARP Setup > ARP Learning

Port	ARP Learning Mode
*	ARP-Reply
1	ARP-Reply
2	ARP-Reply
3	ARP-Reply
4	ARP-Reply
5	ARP-Request
6	ARP-Reply
7	Gratuitous-ARP
8	ARP-Reply
9	ARP-Reply

Apply Cancel

The following table describes the labels in this screen.

Table 169 IP Application > ARP Setup > ARP Learning

LABEL	DESCRIPTION
Port	This field displays the port number.
*	Settings in this row apply to all ports. Use this row only if you want to make some settings the same for all ports. Use this row first to set the common settings and then make adjustments on a port-by-port basis. Changes in this row are copied to all the ports as soon as you make them.
ARP Learning Mode	Select the ARP learning mode the Switch uses on the port. Select ARP-Reply to have the Switch update the ARP table only with the ARP replies to the ARP requests sent by the Switch. Select Gratuitous-ARP to have the Switch update its ARP table with either an ARP reply or a gratuitous ARP request. Select ARP-Request to have the Switch update the ARP table with both ARP replies, gratuitous ARP requests and ARP requests.
Apply	Click Apply to save your changes to the Switch's run-time memory. The Switch loses these changes if it is turned off or loses power, so use the Save link on the top navigation panel to save your changes to the non-volatile memory when you are done configuring.
Cancel	Click Cancel to begin configuring this screen afresh.

CHAPTER 41

Maintenance

41.1 Overview

This chapter explains how to configure the screens that let you maintain the firmware and configuration files.

41.1.1 What You Can Do

- Use the **Maintenance** screen ([Section 41.2 on page 344](#)) to manage firmware and your configuration files.
- Use the **Firmware Upgrade** screen ([Section 41.3 on page 348](#)) to upload the latest firmware.
- Use the **Restore Configuration** screen ([Section 41.4 on page 349](#)) to upload a stored device configuration file.
- Use the **Backup Configuration** screen ([Section 41.5 on page 350](#)) to save your configurations for later use.
- Use the **Erase Running-Configuration** screen ([Section 41.2.1 on page 345](#)) to reset the configuration to the Zyxel default configuration settings.
- Use the **Save Configuration** screen ([Section 41.2.2 on page 346](#)) to save the current configuration settings to a specific configuration file on the Switch.
- Use the **Reboot System** screen ([Section 41.2.3 on page 346](#)) to restart the Switch without physically turning the power off and load a specific configuration file.
- Use the **Tech-Support** screen ([Section 41.6 on page 350](#)) to create reports for customer support if there are problems with the Switch.
- Use the **Certificates** screen ([Section 41.7 on page 352](#)) to see the **Certificate** screen and import the Switch's CA-signed certificates.

41.2 Maintenance Settings

Use this screen to manage firmware and your configuration files. Click **Management > Maintenance** in the navigation panel to open the following screen.

Figure 253 Management > Maintenance

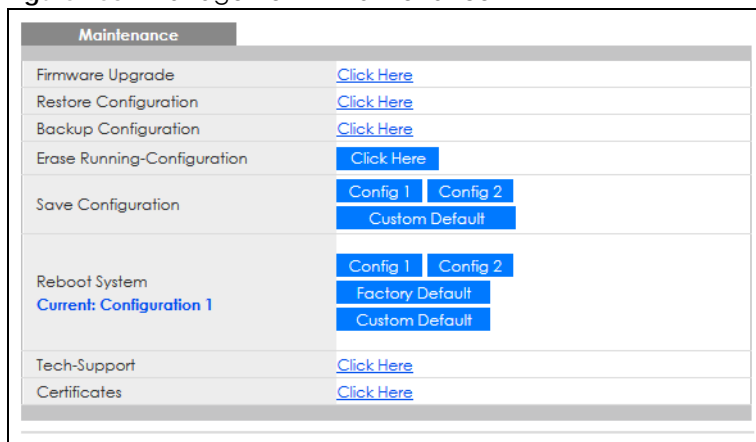

The following table describes the labels in this screen.

Table 170 Management > Maintenance

LABEL	DESCRIPTION
Firmware Upgrade	Click Click Here to go to the Firmware Upgrade screen.
Restore Configuration	Click Click Here to go to the Restore Configuration screen.
Backup Configuration	Click Click Here to go to the Backup Configuration screen.
Erase Running-Configuration	Click Click Here to reset the configuration to the Zyxel default configuration settings.
Save Configuration	Click Config 1 to save the current configuration settings to Configuration 1 on the Switch. Click Config 2 to save the current configuration settings to Configuration 2 on the Switch. Click Custom Default to save the current configuration settings to a customized default file on the Switch. This file can be used instead of the Zyxel factory default configuration file.
Reboot System	Click Config 1 to reboot the Switch and load Configuration 1 on the Switch. Click Config 2 to reboot the Switch and load Configuration 2 on the Switch. Click Factory Default to reboot the Switch and load the Zyxel factory default configuration settings on the Switch. Click Custom Default to reboot the Switch and load a saved customized default file on the Switch. Note: Make sure to click the Save button in any screen to save your settings to the current configuration on the Switch.
Current	This field displays which configuration (Configuration 1 or Configuration 2) is currently operating on the Switch.
Tech-Support	Click Click Here to see the Tech-Support screen. You can set CPU and memory thresholds for log reports and download related log reports for issue analysis. Log reports include CPU history and utilization, crash and memory.
Certificates	Click Click Here to see the Certificate screen and import the Switch's CA-signed certificates.

41.2.1 Erase Running-Configuration

Follow the steps below to reset the Switch back to the Zyxel default configuration settings.

- 1 In the **Maintenance** screen, click the **Click Here** button next to **Erase Running-Configuration** to clear all Switch configuration information you configured and return to the Zyxel default configuration settings.
- 2 Click **OK** to reset all Switch configurations to the Zyxel default configuration settings.

Figure 254 Erase Running-Configuration: Confirmation

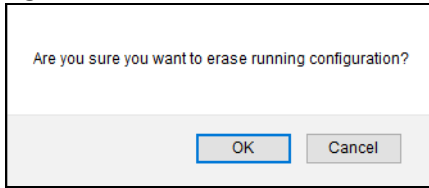

- 3 In the Web Configurator, click the **Save** button in the top of the screen to make the changes take effect. If you want to access the Switch Web Configurator again, you may need to change the IP address of your computer to be in the same subnet as that of the default Switch IP address (192.168.1.1 or DHCP-assigned IP).

41.2.2 Save Configuration

Click **Config 1** to save the current configuration settings permanently to **Configuration 1** on the Switch. These configurations are set up according to your network environment.

Click **Config 2** to save the current configuration settings permanently to **Configuration 2** on the Switch. These configurations are set up according to your network environment.

Click **Custom Default** to save the current configuration settings permanently to a customized default file on the Switch. If configuration changes cause the Switch to behave abnormally, click **Custom Default** (next to **Reboot System**) to have the Switch automatically reboot and restore the saved **Custom Default** configuration file.

Alternatively, click **Save** on the top right-hand corner in any screen to save the configuration changes to the current configuration.

Note: Clicking the **Apply** or **Add** button does NOT save the changes permanently. All unsaved changes are erased after you reboot the Switch.

41.2.3 Reboot System

Reboot System allows you to restart the Switch without physically turning the power off. It also allows you to load configuration one (**Config 1**), configuration two (**Config 2**), a **Custom Default** or the **Factory Default** configuration when you reboot. Follow the steps below to reboot the Switch.

- 1 In the **Maintenance** screen, click a configuration button next to **Reboot System** to reboot and load that configuration file. The confirmation screen displays.
- 2 Click **OK** again and then wait for the Switch to restart. This takes up to 2 minutes. This does not affect the Switch's configuration.

Click **Config 1** and follow steps 1 to 2 to reboot and load configuration one on the Switch.

Click **Config 2** and follow steps 1 to 2 to reboot and load configuration two on the Switch.

Click **Factory Default** and follow steps 1 to 2 to reboot and load Zyxel factory default configuration settings on the Switch.

Click **Custom Default** and follow steps 1 to 2 to reboot and load a customized default file on the Switch. This will save the custom default configuration settings to both **Configuration 1** and **Configuration 2**.

Note: If a customized default file was not saved, clicking **Custom Default** loads the factory default configuration on the Switch.

41.2.4 Factory Default

Follow the steps below to reset the Switch back to the factory defaults.

- 1 Click the **Factory Default** button.
- 2 Click **OK** to continue or **Cancel** to abort.

Figure 255 Load Factory Default: Confirmation

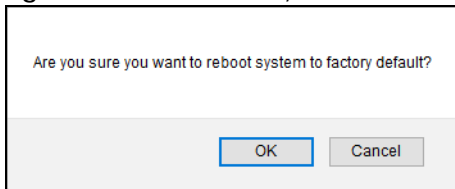

If you want to access the Switch Web Configurator again, you may need to change the IP address of your computer to be in the same subnet as that of the default Switch IP address (192.168.1.1 or DHCP-assigned IP).

41.2.5 Custom Default

Follow the steps below to reset the Switch back to the **Custom Default** configuration file you created. This will save the custom default configuration settings to both **Configuration 1** and **Configuration 2**.

- 1 Click the **Custom Default** button.
- 2 Click **OK** to continue or **Cancel** to abort.

Note: If you did not save a custom default file in the Web Configurator, then the factory default file is restored after you press click **Custom Default** (next to **Reboot System**) on the Switch. You will then have to make all your configurations again on the Switch.

Figure 256 Load Custom Default: Confirmation

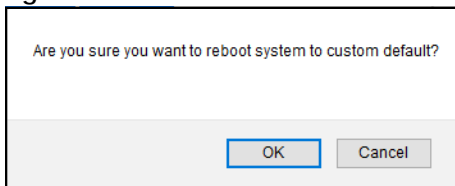

41.3 Firmware Upgrade

Use the following screen to upgrade your Switch to the latest firmware. The Switch supports dual firmware images, **Firmware 1** and **Firmware 2**. Use this screen to specify which image is updated when firmware is uploaded using the Web Configurator and to specify which image is loaded when the Switch starts up.

You can check the **Hardware Version** of your Switch in the **Status** screen to determine which model firmware to upgrade to the Switch. You should see **V2.x** in the **Hardware Version** field. The integer, 2, identifies the GS1920v2 Series. Go to the Zyxel website to download the correct model firmware.

Make sure you have downloaded (and unzipped) the correct model firmware and version to your computer before uploading to the device.

Be sure to upload the correct model firmware as uploading the wrong model firmware may damage your device.

Click **Management > Maintenance > Firmware Upgrade** to view the screen as shown next.

Figure 257 Management > Maintenance > Firmware Upgrade

Firmware Upgrade		Maintenance
Name		Version
GS1920-48HP	Running	V4.70(ABMK.0)b1 08/11/2020
	Firmware 1	V4.70(ABMK.0)b1 08/11/2020
	Firmware 2	V4.60(ABMK.0) 01/20/2020

Current Boot Image	Firmware 1
Config Boot Image	Firmware 1 ▾

To upgrade the internal switch firmware, browse the location of the binary (.BIN) file and click Upgrade button.

Firmware	1 ▾	File Path	<input type="button" value="Browse..."/>	No file selected.
----------	-----	-----------	--	-------------------

The top of firmware upgrade screen shows which firmware version is currently running on the Switch. Type the path and file name of the firmware file you wish to upload to the Switch in the **File Path** text box or click **Choose File** or **Browse** to locate it. Firmware upgrades are only applied after a reboot. Click **Upgrade** to load the new firmware. Select the **Config Boot Image** drop-down list box if you want to reboot the Switch and click **Apply** to apply the new firmware immediately. Click **Upgrade** to load the new firmware.

After the process is complete, see the **System Info** screen to verify your current firmware version number.

Table 171 Management > Maintenance > Firmware Upgrade

LABEL	DESCRIPTION
Name	This is the name of the Switch that you are configuring.
Version	The Switch has 2 firmware sets, Firmware 1 and Firmware 2 , residing in flash. <ul style="list-style-type: none"> Running shows the version number (and model code) and MM/DD/YYYY creation date of the firmware currently in use on the Switch (Firmware 1 or Firmware 2). The firmware information is also displayed at System Information in Basic Setting. Firmware 1 shows its version number (and model code) and MM/DD/YYYY creation date. Firmware 2 shows its version number (and model code) and MM/DD/YYYY creation date.
Current Boot Image	This displays which firmware is currently in use on the Switch (Firmware 1 or Firmware 2).
Config Boot Image	Select which firmware (Firmware 1 or Firmware 2) should load, click Apply and reboot the Switch to see changes, you will also see changes in the Current Boot Image field above as well.
Apply	Click Apply to save your changes to the Switch's run-time memory. The Switch loses these changes if it is turned off or loses power, so use the Save link on the top navigation panel to save your changes to the non-volatile memory when you are done configuring.
Cancel	Click Cancel to begin configuring this screen afresh.
Firmware	Choose to upload the new firmware to (Firmware) 1 or (Firmware) 2 .
File Path	Type the path and file name of the firmware file you wish to upload to the Switch in the File Path text box or click Choose File or Browse to locate it.
Upgrade	Click Upgrade to load the new firmware. s are only applied after a reboot. To reboot, go to Management > Maintenance > Reboot System and click Config 1 , Config 2 or Factory Default (Config 1 , Config 2 and Factory Default are the configuration files you want the Switch to use when it restarts).

41.4 Restore Configuration

Use this screen to restore a previously saved configuration from your computer to the Switch.

Figure 258 Management > Maintenance > Restore Configuration

Type the path and file name of the configuration file you wish to restore in the **File Path** text box or click **Choose File** or **Browse** to locate it. After you have specified the file, click **Restore**. "config" is the name of the configuration file on the Switch, so your backup configuration file is automatically renamed when you restore using this screen.

41.5 Backup Configuration

Backing up your Switch configurations allows you to create various “snap shots” of your device from which you may restore at a later date.

Back up your current Switch configuration to a computer using the **Backup Configuration** screen.

Figure 259 Management > Maintenance > Backup Configuration

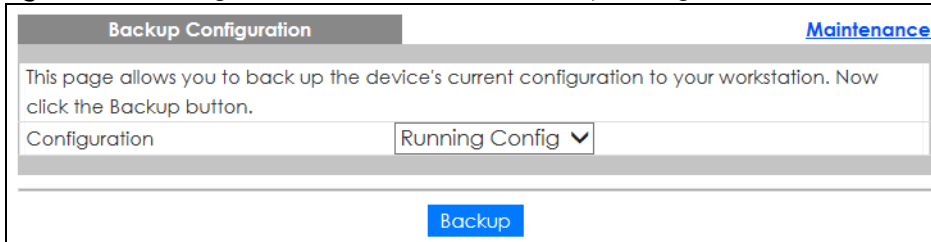

Follow the steps below to back up the current Switch configuration to your computer in this screen.

- 1 Select which Switch configuration file you want to download to your computer.
- 2 Click **Backup**.
- 3 If the current configuration file is open and/or downloaded to your computer automatically, you can click **File > Save As** to save the file to a specific place.

If a dialog box pops up asking whether you want to open or save the file, click **Save** or **Save File** to download it to the default downloads folder on your computer. If a **Save As** screen displays after you click **Save** or **Save File**, choose a location to save the file on your computer from the **Save in** drop-down list box and type a descriptive name for it in the **File name** list box. Click **Save** to save the configuration file to your computer.

41.6 Tech-Support

The Tech-Support feature is a log enhancement tool that logs useful information such as CPU utilization history, memory and Mbuf (Memory Buffer) log and crash reports for issue analysis by customer support should you have difficulty with your Switch. The Tech Support menu eases your effort in obtaining reports and it is also available in CLI command by typing “Show tech-support” command.

Click **Management > Maintenance > Tech-Support** to see the following screen.

Figure 260 Management > Maintenance > Tech-Support

Tech-Support		Maintenance	
CPU	threshold	100	keep 5 seconds
Mbuf	threshold	50	%
Apply Cancel			
All	Download		
Crash	Download		
CPU history	Download		
Memory section	Download		
Mbuf	Download		
ROM	Download		

You may need WordPad or similar software to see the log report correctly. The table below describes the fields in the above screen.

Table 172 Management > Maintenance > Tech-Support

LABEL	DESCRIPTION
CPU	Type a number ranging from 50 to 100 in the CPU threshold box, and type another number ranging from 5 to 60 in the seconds box then click Apply . For example, 80 for CPU threshold and 5 for seconds means a log will be created when CPU utilization reaches over 80% and lasts for 5 seconds. The log report holds 7 days of CPU log data and is stored in volatile memory (RAM). The data is lost if the Switch is turned off or in event of power outage. After 7 days, the logs wrap around and new ones and replace the earliest ones. The higher the CPU threshold number, the fewer logs will be created, and the less data technical support will have to analyze and vice versa.
Mbuf	Type a number ranging from 50 to 100 in the Mbuf (Memory Buffer) threshold box. The Mbuf log report is stored in flash (permanent) memory. For example, Mbuf 50 means a log will be created when the Mbuf utilization is over 50%. The higher the Mbuf threshold number, the fewer logs will be created, and the less data technical support will have to analyze and vice versa.
Apply	Click Apply to save your changes to the Switch's run-time memory. The Switch loses these changes if it is turned off or loses power, so use the Save link on the top navigation panel to save your changes to the non-volatile memory when you are done configuring.
Cancel	Click Cancel to begin configuring this screen afresh.
All	Click Download to see all the log report and system status. This log report is stored in flash memory. If the All log report is too large, you can download the log reports separately below.
Crash	Click Download to see the crash log report. The log will include information of the last crash and is stored in flash memory.
CPU history	Click Download to see the CPU history log report. The 7-days log is stored in RAM and you will need to save it, otherwise it will be lost when the Switch is shutdown or during power outage.
Memory Section	Click Download to see the memory section log report. This log report is stored in flash memory.

Table 172 Management > Maintenance > Tech-Support (continued)

LABEL	DESCRIPTION
Mbuf	Click Download to see the Mbuf log report. The log includes Mbuf over threshold information. This log report is stored in flash memory.
ROM	Click Download to see the Read Only Memory (ROM) log report. This report is stored in flash memory.

41.6.1 Tech-Support Download

When you click **Download** to save your current Switch configuration to a computer, the following screen appears. When the log report has downloaded successfully, click **Back** to return to the previous screen.

Figure 261 Management > Maintenance > Tech-Support: Download

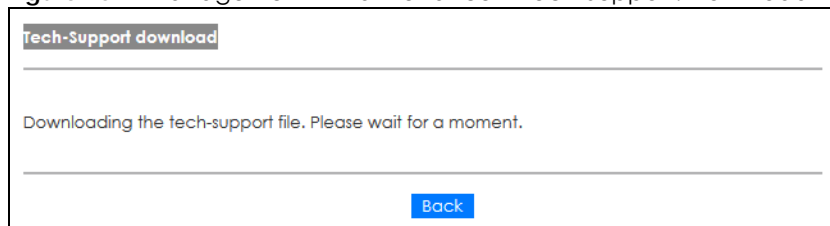

41.7 Certificates

The Switch can use HTTPS certificates that are verified by a third party to create secure HTTPS connections between your computer and the Switch. This way, you may securely access the Switch using the Web Configurator. See [Section 42.7.3 on page 374](#) for more information about HTTPS.

Certificates are based on public-private key pairs. A certificate contains the certificate owner's identity and public key. Certificates provide a way to exchange public keys for use in authentication.

Click **Management > Maintenance > Certificates** to open the following screen. Use this screen to import the Switch's CA-signed certificates.

Figure 262 Management > Maintenance > Certificates

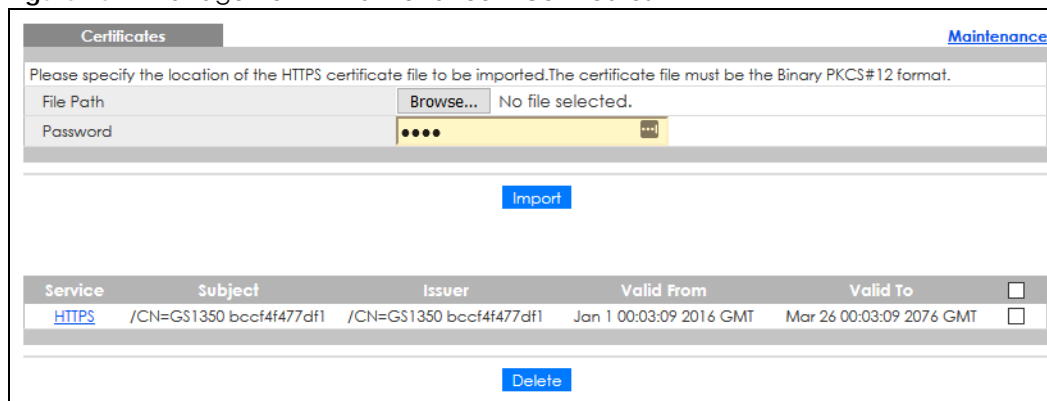

The following table describes the labels in this screen.

Table 173 Management > Maintenance > Certificates

LABEL	DESCRIPTION
File Path	Click Choose File or Browse to find the certificate file you want to upload.
Password	Enter the certificate file's password that was created when the PKCS #12 file was exported. The password consists of up to 32 ASCII characters.
Import	Click this button to save the certificate that you have enrolled from a certification authority from your computer to the Switch.
Service	This field displays the service type that this certificate is for.
Subject	This field displays identifying information about the certificate's owner, such as CN (Common Name), OU (Organizational Unit or department), O (Organization or company) and C (Country). It is recommended that each certificate have unique subject information.
Issuer	This field displays identifying information about the certificate's issuing certification authority, such as a common name, organizational unit or department, organization or company and country.
Valid From	This field displays the date that the certificate becomes applicable.
Valid To	This field displays the date that the certificate expires.
	Select an entry's check box to select a specific entry.
Delete	Click this button to delete the certificate (or certification request). You cannot delete a certificate that one or more features is configured to use.

41.7.1 HTTPS Certificates

Use this screen to view the HTTPS certificate details. Click a hyperlink in the **Service** column in the **Management > Maintenance > Certificates** screen to open the following screen.

Figure 263 Management > Maintenance > Certificates > HTTPS

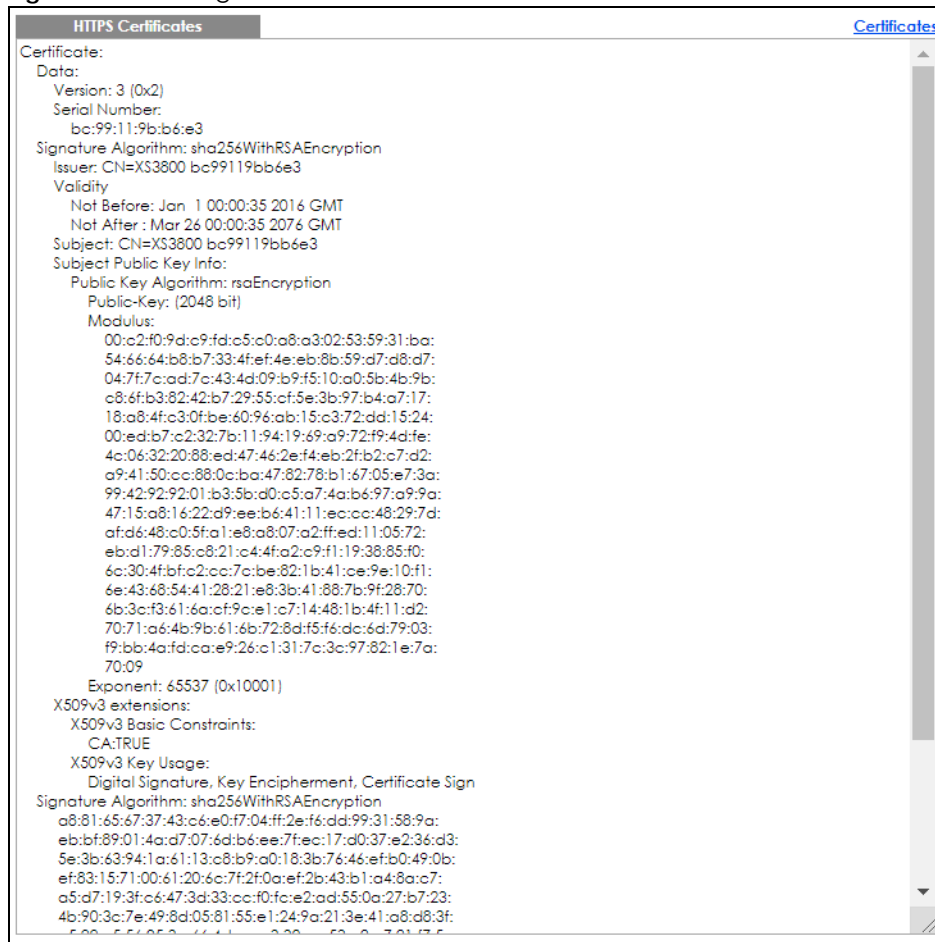

41.8 Technical Reference

This section provides technical background information on the topics discussed in this chapter.

41.8.1 FTP Command Line

This section shows some examples of uploading to or downloading files from the Switch using FTP commands. First, understand the filename conventions.

41.8.2 Filename Conventions

The configuration file (also known as the romfile or ROM) contains the Zyxel factory default configuration settings in the screens such as password, Switch setup, IP Setup, and so on. Once you have customized the Switch's settings, they can be saved back to your computer under a filename of your choosing.

ZyNOS (Zyxel Network Operating System sometimes referred to as the "ras" file) is the system firmware

and has a "bin" filename extension.

Table 174 Filename Conventions

FILE TYPE	INTERNAL NAME	EXTERNAL NAME	DESCRIPTION
Configuration File	config	*.cfg	This is the configuration filename on the Switch. Uploading the config file replaces the specified configuration file system, including your Switch configurations, system-related data (including the default password), the error log and the trace log.
Firmware	ras	*.bin	This is the generic name for the ZyNOS firmware on the Switch.

41.8.2.1 Example FTP Commands

```
ftp> put firmware.bin ras
```

This is a sample FTP session showing the transfer of the computer file "firmware.bin" to the Switch.

```
ftp> get config config.cfg
```

This is a sample FTP session saving the current configuration to a file called "config.cfg" on your computer.

If your (T)FTP client does not allow you to have a destination filename different than the source, you will need to rename them as the Switch only recognizes "config" and "ras". Be sure you keep unaltered copies of both files for later use.

Be sure to upload the correct model firmware as uploading the wrong model firmware may damage your device.

41.8.3 FTP Command Line Procedure

- 1 Launch the FTP client on your computer.
- 2 Enter `open`, followed by a space and the IP address of your Switch.
- 3 Press [ENTER] when prompted for a username.
- 4 Enter your password as requested (the default is "1234").
- 5 Enter `bin` to set transfer mode to binary.
- 6 Use `put` to transfer files from the computer to the Switch, for example, `put firmware.bin ras` transfers the firmware on your computer (`firmware.bin`) to the Switch and renames it to "ras". Similarly, `put config.cfg config` transfers the configuration file on your computer (`config.cfg`) to the Switch and renames it to "config". Likewise `get config config.cfg` transfers the configuration file on the Switch to your computer and renames it to "config.cfg". See [Table 174 on page 355](#) for more information on filename conventions.
- 7 Enter `quit` to exit the ftp prompt.

41.8.4 GUI-based FTP Clients

The following table describes some of the commands that you may see in GUI-based FTP clients.

Table 175 General Commands for GUI-based FTP Clients

COMMAND	DESCRIPTION
Host Address	Enter the address of the host server.
Login Type	<p>Anonymous.</p> <p>This is when a user I.D. and password is automatically supplied to the server for anonymous access. Anonymous logins will work only if your ISP or service administrator has enabled this option.</p> <p>Normal.</p> <p>The server requires a unique User ID and Password to login.</p>
Transfer Type	Transfer files in either ASCII (plain text format) or in binary mode. Configuration and firmware files should be transferred in binary mode.
Initial Remote Directory	Specify the default remote directory (path).
Initial Local Directory	Specify the default local directory (path).

41.8.5 FTP Restrictions

FTP will not work when:

- FTP service is disabled in the **Service Access Control** screen.
- The IP addresses in the **Remote Management** screen does not match the client IP address. If it does not match, the Switch will disconnect the FTP session immediately.

CHAPTER 42

Access Control

42.1 Access Control Overview

This chapter describes how to control access to the Switch.

FTP is allowed one session each, Telnet and SSH share nine sessions, up to five web sessions (five different user names and passwords) and/or limitless SNMP access control sessions are allowed.

Table 176 Access Control Overview

SSH	Telnet	FTP	Web	SNMP
Share up to nine sessions		One session	Up to five accounts	No limit

Telnet access control session cannot coexist when multi-login is disabled.

42.1.1 What You Can Do

- Use the **Access Control** screen ([Section 42.2 on page 357](#)) to display the main screen.
- Use the **SNMP** screen ([Section 42.3 on page 358](#)) to configure your SNMP settings.
- Use the **Trap Group** screen ([Section 42.3.1 on page 359](#)) to specify the types of SNMP traps that should be sent to each SNMP manager.
- Use the **User Information** screen ([Section 42.3.3 on page 361](#)) to create SNMP users for authentication with managers using SNMP v3 and associate them to SNMP groups.
- Use the **Logins** screens ([Section 42.4 on page 363](#)) to assign which users can access the Switch via Web Configurator at any one time.
- Use the **Service Access Control** screen ([Section 42.5 on page 364](#)) to decide what services you may use to access the Switch.
- Use the **Remote Management** screen ([Section 42.6 on page 365](#)) to specify a group of one or more "trusted computers" from which an administrator may use a service to manage the Switch.

42.2 Access Control Main Settings

Use this screen to display the main screen.

Click **Management > Access Control** in the navigation panel to display the main screen as shown.

Figure 264 Management > Access Control

Access Control	
SNMP	Click Here
Logins	Click Here
Service Access Control	Click Here
Remote Management	Click Here

The following table describes the labels in this screen.

Table 177 Management > Access Control

LABEL	DESCRIPTION
SNMP	Click this link to configure your SNMP settings.
Logins	Click this link to assign which users can access the Switch via Web Configurator at any one time.
Service Access Control	Click this link to decide what services you may use to access the Switch.
Remote Management	Click this link to specify a group of one or more "trusted computers" from which an administrator may use a service to manage the Switch.

42.3 Configure SNMP

Use this screen to configure your SNMP settings.

Click **Management > Access Control > SNMP** to view the screen as shown.

Figure 265 Management > Access Control > SNMP

SNMP		Access Control	Trap Group	User
General Setting				
Version	v2c ▾			
Get Community	public			
Set Community	public			
Trap Community	public			
Trap Destination				
Version	IP	Port	Username	
v2c ▾	0.0.0.0	162		
v2c ▾	0.0.0.0	162		
v2c ▾	0.0.0.0	162		
v2c ▾	0.0.0.0	162		
<input type="button" value="Apply"/> <input type="button" value="Cancel"/>				

The following table describes the labels in this screen.

Table 178 Management > Access Control > SNMP

LABEL	DESCRIPTION
General Setting	Use this section to specify the SNMP version and community (password) values.
Version	Select the SNMP version for the Switch. The SNMP version on the Switch must match the version on the SNMP manager. Choose SNMP version 2c (v2c), SNMP version 3 (v3) or both (v3v2c). SNMP version 2c is backwards compatible with SNMP version 1.
Get Community	Enter the Get Community string, which is the password for the incoming Get- and GetNext-requests from the management station. The Get Community string is only used by SNMP managers using SNMP version 2c or lower.
Set Community	Enter the Set Community , which is the password for incoming Set- requests from the management station. The Set Community string is only used by SNMP managers using SNMP version 2c or lower.
Trap Community	Enter the Trap Community string, which is the password sent with each trap to the SNMP manager. The Trap Community string is only used by SNMP managers using SNMP version 2c or lower.
Trap Destination	Use this section to configure where to send SNMP traps from the Switch.
Version	Specify the version of the SNMP trap messages.
IP	Enter the IP addresses of up to four managers to send your SNMP traps to.
Port	Enter the port number upon which the manager listens for SNMP traps.
Username	Enter the username to be sent to the SNMP manager along with the SNMP v3 trap. This username must match an existing account on the Switch (configured in the Management > Access Control > SNMP > User screen).
Apply	Click Apply to save your changes to the Switch's run-time memory. The Switch loses these changes if it is turned off or loses power, so use the Save link on the top navigation panel to save your changes to the non-volatile memory when you are done configuring.
Cancel	Click Cancel to begin configuring this screen afresh.

42.3.1 Configure SNMP Trap Group

From the **SNMP** screen, click **Trap Group** to view the screen as shown. Use the **Trap Group** screen to specify the types of SNMP traps that should be sent to each SNMP manager.

Figure 266 Management > Access Control > SNMP > Trap Group

The screenshot shows the 'Trap Group' configuration interface. At the top, there is a 'Trap Destination IP' dropdown menu. Below this is a table with two main columns: 'Type' and 'Options'. The 'Type' column lists five categories: System, Interface, AAA, IP, and Switch. The 'Options' column lists various trap types, each with a checkbox. The options are: coldstart, warmstart, poe, linkup, linkdown, lldp, authentication, ping, traceroute, stp, and rmon. At the bottom of the screen, there are two buttons: 'Apply' and 'Cancel'.

The following table describes the labels in this screen.

Table 179 Management > Access Control > SNMP > Trap Group

LABEL	DESCRIPTION
Trap Destination IP	Select one of your configured trap destination IP addresses. These are the IP addresses of the SNMP managers. You must first configure a trap destination IP address in the SNMP Setting screen. Use the rest of the screen to select which traps the Switch sends to that SNMP manager.
Type	Select the categories of SNMP traps that the Switch is to send to the SNMP manager.
Options	Select the individual SNMP traps that the Switch is to send to the SNMP station. The traps are grouped by category. Selecting a category automatically selects all of the category's traps. Clear the check boxes for individual traps that you do not want the Switch to send to the SNMP station. Clearing a category's check box automatically clears all of the category's trap check boxes (the Switch only sends traps from selected categories).
Apply	Click Apply to save your changes to the Switch's run-time memory. The Switch loses these changes if it is turned off or loses power, so use the Save link on the top navigation panel to save your changes to the non-volatile memory when you are done configuring.
Cancel	Click Cancel to begin configuring this screen afresh.

42.3.2 Enable or Disable Sending of SNMP Traps on a Port

From the **SNMP > Trap Group** screen, click **Port** to view the screen as shown. Use this screen to set whether a trap received on the ports would be sent to the SNMP manager.

Figure 267 Management > Access Control > SNMP > Trap Group > Port

Port	Active
*	<input type="checkbox"/>
1	<input checked="" type="checkbox"/>
2	<input checked="" type="checkbox"/>
3	<input checked="" type="checkbox"/>
4	<input checked="" type="checkbox"/>
5	<input checked="" type="checkbox"/>
6	<input checked="" type="checkbox"/>
7	<input checked="" type="checkbox"/>
8	<input checked="" type="checkbox"/>
9	<input checked="" type="checkbox"/>
10	<input checked="" type="checkbox"/>
48	<input checked="" type="checkbox"/>
49	<input checked="" type="checkbox"/>
50	<input checked="" type="checkbox"/>

The following table describes the labels in this screen.

Table 180 Management > Access Control > SNMP > Trap Group > Port

LABEL	DESCRIPTION
Option	Select the trap type you want to configure here.
Port	This field displays a port number.

Table 180 Management > Access Control > SNMP > Trap Group > Port (continued)

LABEL	DESCRIPTION
*	Settings in this row apply to all ports. Use this row only if you want to make some of the settings the same for all ports. Use this row first to set the common settings and then make adjustments on a port-by-port basis. Changes in this row are copied to all the ports as soon as you make them.
Active	Select this check box to enable the trap type of SNMP traps on this port. The Switch sends the related traps received on this port to the SNMP manager. Clear this check box to disable the sending of SNMP traps on this port.
Apply	Click Apply to save your changes to the Switch's run-time memory. The Switch loses these changes if it is turned off or loses power, so use the Save link on the top navigation panel to save your changes to the non-volatile memory when you are done configuring.
Cancel	Click Cancel to begin configuring this screen afresh.

42.3.3 Configure SNMP User

From the **SNMP** screen, click **User** to view the screen as shown. Use the **User** screen to create SNMP users for authentication with managers using SNMP v3 and associate them to SNMP groups. An SNMP user is an SNMP manager.

Figure 268 Management > Access Control > SNMP > User

The following table describes the labels in this screen.

Table 181 Management > Access Control > SNMP > User

LABEL	DESCRIPTION
User Information	Note: Use the username and password of the login accounts you specify in this screen to create accounts on the SNMP v3 manager.
Username	Specify the username of a login account on the Switch.

Table 181 Management > Access Control > SNMP > User (continued)

LABEL	DESCRIPTION
Security Level	<p>Select whether you want to implement authentication and/or encryption for SNMP communication from this user. Choose:</p> <ul style="list-style-type: none"> • noauth – to use the username as the password string to send to the SNMP manager. This is equivalent to the Get, Set and Trap Community in SNMP v2c. This is the lowest security level. • auth – to implement an authentication algorithm for SNMP messages sent by this user. • priv – to implement authentication and encryption for SNMP messages sent by this user. This is the highest security level. <p>Note: The settings on the SNMP manager must be set at the same security level or higher than the security level settings on the Switch.</p>
Authentication	<p>Select an authentication algorithm. MD5 (Message Digest 5) and SHA (Secure Hash Algorithm) are hash algorithms used to authenticate SNMP data. SHA authentication is generally considered stronger than MD5, but is slower.</p>
Password	<p>Enter the password of up to 32 ASCII characters for SNMP user authentication.</p>
Privacy	<p>Specify the encryption method for SNMP communication from this user. You can choose one of the following:</p> <ul style="list-style-type: none"> • DES – Data Encryption Standard is a widely used (but breakable) method of data encryption. It applies a 56-bit key to each 64-bit block of data. • AES – Advanced Encryption Standard is another method for data encryption that also uses a secret key. AES applies a 128-bit key to 128-bit blocks of data.
Password	<p>Enter the password of up to 32 ASCII characters for encrypting SNMP packets.</p>
Group	<p>SNMP v3 adopts the concept of View-based Access Control Model (VACM) group. SNMP managers in one group are assigned common access rights to MIBs. Specify in which SNMP group this user is.</p> <p>admin – Members of this group can perform all types of system configuration, including the management of administrator accounts.</p> <p>readwrite – Members of this group have read and write rights, meaning that the user can create and edit the MIBs on the Switch, except the user account and AAA configuration.</p> <p>readonly – Members of this group have read rights only, meaning the user can collect information from the Switch.</p>
Add	<p>Click this to create a new entry or to update an existing one.</p> <p>This saves your changes to the Switch's run-time memory. The Switch loses these changes if it is turned off or loses power, so use the Save link on the top navigation panel to save your changes to the non-volatile memory when you are done configuring.</p>
Cancel	<p>Click Cancel to reset the fields to your previous configuration.</p>
Clear	<p>Click Clear to reset the fields to the factory defaults.</p>
Index	<p>This is a read-only number identifying a login account on the Switch. Click on an index number to view more details and edit an existing account.</p>
Username	<p>This field displays the username of a login account on the Switch.</p>
Security Level	<p>This field displays whether you want to implement authentication and/or encryption for SNMP communication with this user.</p>
Authentication	<p>This field displays the authentication algorithm used for SNMP communication with this user.</p>
Privacy	<p>This field displays the encryption method used for SNMP communication with this user.</p>
Group	<p>This field displays the SNMP group to which this user belongs.</p>
	<p>Select an entry's check box to select a specific entry. Otherwise, select the check box in the table heading row to select all entries.</p>
Delete	<p>Click Delete to remove the selected entry from the summary table.</p>
Cancel	<p>Click Cancel to begin configuring this screen afresh.</p>

42.4 Set Up Login Accounts

Up to five people (one administrator and four non-administrators) may access the Switch via Web Configurator at any one time.

- An administrator is someone who can both view and configure Switch changes. The username for the Administrator is always **admin**. The default administrator password is **1234**.

Note: It is highly recommended that you change the default administrator password (**1234**).

- A non-administrator (username is something other than **admin**) is someone who can view and/or configure Switch settings. The configuration right varies depending on the user's privilege level.

Click **Management > Access Control > Logins** to view the screen as shown.

Figure 269 Management > Access Control > Logins

Login	User Name	Password	Retype to confirm	Privilege
1				
2				
3				
4				

The following table describes the labels in this screen.

Table 182 Management > Access Control > Logins

LABEL	DESCRIPTION
Administrator	This is the default administrator account with the "admin" user name. You cannot change the default administrator user name.
Old Password	Type the existing system password (1234 is the default password when shipped).
New Password	Enter your new system password.
Retype to confirm	Retype your new system password for confirmation.
Edit Logins	You may configure passwords for up to four users. These users can have read-only or read/write access.
User Name	Set a user name (up to 32 ASCII characters long).
Password	Enter your new system password.

Table 182 Management > Access Control > Logins (continued)

LABEL	DESCRIPTION
Retype to confirm	Retype your new system password for confirmation.
Privilege	<p>Type the privilege level for this user. At the time of writing, users may have a privilege level of 0, 3, 13, or 14 representing different configuration rights as shown below.</p> <ul style="list-style-type: none"> 0 – Display basic system information. 3 – Display configuration or status. 13 – Configure features except for login accounts, SNMP user accounts, the authentication method sequence and authorization settings, multiple logins, administrator and enable passwords, and configuration information display. 14 – Configure login accounts, SNMP user accounts, the authentication method sequence and authorization settings, multiple logins, and administrator and enable passwords, and display configuration information. <p>Users can run command lines if the session's privilege level is greater than or equal to the command's privilege level. The session privilege initially comes from the privilege of the login account. For example, if the user has a privilege of 5, he or she can run commands that requires privilege level of 5 or less but not more.</p>
Apply	Click Apply to save your changes to the Switch's run-time memory. The Switch loses these changes if it is turned off or loses power, so use the Save link on the top navigation panel to save your changes to the non-volatile memory when you are done configuring.
Cancel	Click Cancel to begin configuring this screen afresh.

42.5 Service Access Control

Service Access Control allows you to decide what services you may use to access the Switch. You may also change the default service port and configure "trusted computers" for each service in the **Remote Management** screen (discussed later). Click **Access Control** to go back to the main **Access Control** screen.

Figure 270 Management > Access Control > Service Access Control

Services	Active	Service Port	Timeout	Login Timeout
Telnet	<input checked="" type="checkbox"/>	23	5 Minutes	150 Seconds
SSH	<input checked="" type="checkbox"/>	22		
FTP	<input checked="" type="checkbox"/>	21	5 Minutes	
HTTP	<input checked="" type="checkbox"/>	80	55 Minutes	
HTTPS	<input checked="" type="checkbox"/>	443		
ICMP	<input checked="" type="checkbox"/>			
SNMP	<input checked="" type="checkbox"/>			

The following table describes the fields in this screen.

Table 183 Management > Access Control > Service Access Control

LABEL	DESCRIPTION
Services	Services you may use to access the Switch are listed here. Telnet and SSH give access to a limited version of the Command Line Interface (CLI) to display information.
Active	Select this option for the corresponding services that you want to allow to access the Switch.

Table 183 Management > Access Control > Service Access Control (continued)

LABEL	DESCRIPTION
Service Port	For Telnet, SSH, FTP, HTTP or HTTPS services, you may change the default service port by typing the new port number in the Service Port field. If you change the default port number then you will have to let people (who wish to use the service) know the new port number for that service.
Timeout	Enter how many minutes (from 1 to 255) a management session can be left idle before the session times out. After it times out you have to log in with your password again. Very long idle timeouts may have security risks.
Login Timeout	<p>The Telnet or SSH server do not allow multiple user logins at the same time. Enter how many seconds (from 30 to 300 seconds) a login session times out. After it times out you have to start the login session again. Very long login session timeouts may have security risks.</p> <p>For example, if User A attempts to connect to the Switch (via SSH), but during the login stage, do not enter the user name and/or password, User B cannot connect to the Switch (via SSH) before the Login Timeout for User A expires (default 150 seconds).</p>
Apply	Click Apply to save your changes to the Switch's run-time memory. The Switch loses these changes if it is turned off or loses power, so use the Save link on the top navigation panel to save your changes to the non-volatile memory when you are done configuring.
Cancel	Click Cancel to begin configuring this screen afresh.

42.6 Remote Management

Use this screen to specify a group of one or more "trusted computers" from which an administrator may use a service to manage the Switch.

Click **Management > Access Control > Remote Management** to view the screen as shown next.

Click **Access Control** to return to the **Access Control** screen.

Figure 271 Management > Access Control > Remote Management

Remote Management				Access Control							
Secured Client Setup											
Entry	Active	Start Address	End Address	Telnet	FTP	HTTP	ICMP	SNMP	SSH	HTTPS	
1	<input checked="" type="checkbox"/>	0.0.0.0	0.0.0.0	<input checked="" type="checkbox"/>	<input checked="" type="checkbox"/>	<input checked="" type="checkbox"/>	<input checked="" type="checkbox"/>	<input checked="" type="checkbox"/>	<input checked="" type="checkbox"/>	<input checked="" type="checkbox"/>	
2	<input type="checkbox"/>	0.0.0.0	0.0.0.0	<input type="checkbox"/>	<input type="checkbox"/>	<input type="checkbox"/>	<input type="checkbox"/>	<input type="checkbox"/>	<input type="checkbox"/>	<input type="checkbox"/>	
3	<input type="checkbox"/>	0.0.0.0	0.0.0.0	<input type="checkbox"/>	<input type="checkbox"/>	<input type="checkbox"/>	<input type="checkbox"/>	<input type="checkbox"/>	<input type="checkbox"/>	<input type="checkbox"/>	
4	<input type="checkbox"/>	0.0.0.0	0.0.0.0	<input type="checkbox"/>	<input type="checkbox"/>	<input type="checkbox"/>	<input type="checkbox"/>	<input type="checkbox"/>	<input type="checkbox"/>	<input type="checkbox"/>	
5	<input type="checkbox"/>	0.0.0.0	0.0.0.0	<input type="checkbox"/>	<input type="checkbox"/>	<input type="checkbox"/>	<input type="checkbox"/>	<input type="checkbox"/>	<input type="checkbox"/>	<input type="checkbox"/>	
6	<input type="checkbox"/>	0.0.0.0	0.0.0.0	<input type="checkbox"/>	<input type="checkbox"/>	<input type="checkbox"/>	<input type="checkbox"/>	<input type="checkbox"/>	<input type="checkbox"/>	<input type="checkbox"/>	
7	<input type="checkbox"/>	0.0.0.0	0.0.0.0	<input type="checkbox"/>	<input type="checkbox"/>	<input type="checkbox"/>	<input type="checkbox"/>	<input type="checkbox"/>	<input type="checkbox"/>	<input type="checkbox"/>	
8	<input type="checkbox"/>	0.0.0.0	0.0.0.0	<input type="checkbox"/>	<input type="checkbox"/>	<input type="checkbox"/>	<input type="checkbox"/>	<input type="checkbox"/>	<input type="checkbox"/>	<input type="checkbox"/>	
9	<input type="checkbox"/>	0.0.0.0	0.0.0.0	<input type="checkbox"/>	<input type="checkbox"/>	<input type="checkbox"/>	<input type="checkbox"/>	<input type="checkbox"/>	<input type="checkbox"/>	<input type="checkbox"/>	
10	<input type="checkbox"/>	0.0.0.0	0.0.0.0	<input type="checkbox"/>	<input type="checkbox"/>	<input type="checkbox"/>	<input type="checkbox"/>	<input type="checkbox"/>	<input type="checkbox"/>	<input type="checkbox"/>	
11	<input type="checkbox"/>	0.0.0.0	0.0.0.0	<input type="checkbox"/>	<input type="checkbox"/>	<input type="checkbox"/>	<input type="checkbox"/>	<input type="checkbox"/>	<input type="checkbox"/>	<input type="checkbox"/>	
12	<input type="checkbox"/>	0.0.0.0	0.0.0.0	<input type="checkbox"/>	<input type="checkbox"/>	<input type="checkbox"/>	<input type="checkbox"/>	<input type="checkbox"/>	<input type="checkbox"/>	<input type="checkbox"/>	
13	<input type="checkbox"/>	0.0.0.0	0.0.0.0	<input type="checkbox"/>	<input type="checkbox"/>	<input type="checkbox"/>	<input type="checkbox"/>	<input type="checkbox"/>	<input type="checkbox"/>	<input type="checkbox"/>	
14	<input type="checkbox"/>	0.0.0.0	0.0.0.0	<input type="checkbox"/>	<input type="checkbox"/>	<input type="checkbox"/>	<input type="checkbox"/>	<input type="checkbox"/>	<input type="checkbox"/>	<input type="checkbox"/>	
15	<input type="checkbox"/>	0.0.0.0	0.0.0.0	<input type="checkbox"/>	<input type="checkbox"/>	<input type="checkbox"/>	<input type="checkbox"/>	<input type="checkbox"/>	<input type="checkbox"/>	<input type="checkbox"/>	
16	<input type="checkbox"/>	0.0.0.0	0.0.0.0	<input type="checkbox"/>	<input type="checkbox"/>	<input type="checkbox"/>	<input type="checkbox"/>	<input type="checkbox"/>	<input type="checkbox"/>	<input type="checkbox"/>	

The following table describes the labels in this screen.

Table 184 Management > Access Control > Remote Management

LABEL	DESCRIPTION
Entry	This is the client set index number. A "client set" is a group of one or more "trusted computers" from which an administrator may use a service to manage the Switch.
Active	Select this check box to activate this secured client set. Clear the check box if you wish to temporarily disable the set without deleting it.
Start Address	Configure the IP address range of trusted computers from which you can manage this Switch.
End Address	The Switch checks if the client IP address of a computer requesting a service or protocol matches the range set here. The Switch immediately disconnects the session if it does not match.
Telnet/FTP/HTTP/ICMP/SNMP/SSH/HTTPS	Select services that may be used for managing the Switch from the specified trusted computers.
Apply	Click Apply to save your changes to the Switch's run-time memory. The Switch loses these changes if it is turned off or loses power, so use the Save link on the top navigation panel to save your changes to the non-volatile memory when you are done configuring.
Cancel	Click Cancel to begin configuring this screen afresh.

42.7 Technical Reference

This section provides technical background information on the topics discussed in this chapter.

42.7.1 About SNMP

Simple Network Management Protocol (SNMP) is an application layer protocol used to manage and monitor TCP/IP-based devices. SNMP is used to exchange management information between the network management system (NMS) and a network element (NE). A manager station can manage and monitor the Switch through the network via SNMP version 1 (SNMPv1), SNMP version 2c or SNMP version 3. The next figure illustrates an SNMP management operation. SNMP is only available if TCP/IP is configured.

Figure 272 SNMP Management Model

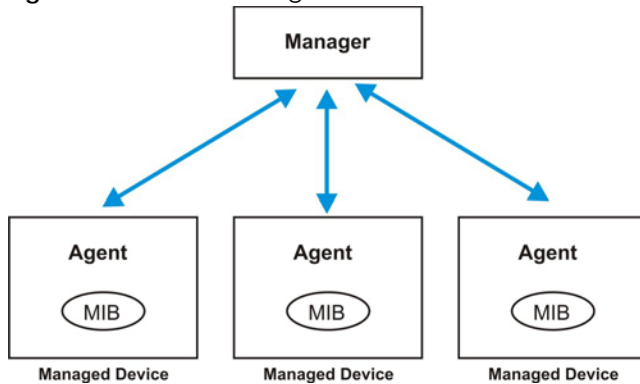

An SNMP managed network consists of two main components: agents and a manager.

An agent is a management software module that resides in a managed Switch (the Switch). An agent translates the local management information from the managed Switch into a form compatible with SNMP. The manager is the console through which network administrators perform network management functions. It executes applications that control and monitor managed devices.

The managed devices contain object variables or managed objects that define each piece of information to be collected about a Switch. Examples of variables include number of packets received, node port status and so on. A Management Information Base (MIB) is a collection of managed objects. SNMP allows a manager and agents to communicate for the purpose of accessing these objects.

SNMP itself is a simple request or response protocol based on the manager or agent model. The manager issues a request and the agent returns responses using the following protocol operations:

Table 185 SNMP Commands

LABEL	DESCRIPTION
Get	Allows the manager to retrieve an object variable from the agent.
GetNext	Allows the manager to retrieve the next object variable from a table or list within an agent. In SNMPv1, when a manager wants to retrieve all elements of a table from an agent, it initiates a Get operation, followed by a series of GetNext operations.
Set	Allows the manager to set values for object variables within an agent.
Trap	Used by the agent to inform the manager of some events.

SNMP v3 and Security

SNMP v3 enhances security for SNMP management. SNMP managers can be required to authenticate with agents before conducting SNMP management sessions.

Security can be further enhanced by encrypting the SNMP messages sent from the managers.

Encryption protects the contents of the SNMP messages. When the contents of the SNMP messages are encrypted, only the intended recipients can read them.

Supported MIBs

MIBs let administrators collect statistics and monitor status and performance.

The Switch supports the following MIBs:

- SNMP MIB II (RFC 1213)
- RFC 1157 SNMP v1
- RFC 1493 Bridge MIBs
- RFC 1643 Ethernet MIBs
- RFC 1155 SMI
- RFC 2674 SNMPv2, SNMPv2c
- RFC 1757 RMON
- SNMPv2, SNMPv2c or later version, compliant with RFC 2011 SNMPv2 MIB for IP, RFC 2012 SNMPv2 MIB for TCP, RFC 2013 SNMPv2 MIB for UDP

SNMP Traps

The Switch sends traps to an SNMP manager when an event occurs. The following tables outline the SNMP traps by category.

An OID (Object ID) that begins with "1.3.6.1.4.1.890.1.15" is defined in private MIBs. Otherwise, it is a standard MIB OID.

Table 186 SNMP System Traps

OPTION	OBJECT LABEL	OBJECT ID	DESCRIPTION
coldstart	coldStart	1.3.6.1.6.3.1.1.5.1	This trap is sent when the Switch is turned on.
warmstart	warmStart	1.3.6.1.6.3.1.1.5.2	This trap is sent when the Switch restarts.
fanspeed	zyHwMonitorFanSpeedOutOfRange	1.3.6.1.4.1.890.1.15.3.26.2.1	This trap is sent when the fan speed goes above or below the normal operating range.
	zyHwMonitorFANSpeedOutOfRangeRecovered	1.3.6.1.4.1.890.1.15.3.26.2.6	This trap is sent when the fan speed is recovered from the out of range to normal operating range.
temperature	zyHwMonitorTemperatureOutOfRange	1.3.6.1.4.1.890.1.15.3.26.2.2	This trap is sent when the temperature goes above or below the normal operating range.
	zyHwMonitorTemperatureOutOfRangeRecovered	1.3.6.1.4.1.890.1.15.3.26.2.7	This trap is sent when the temperature is recovered from the out of range to normal operating range.
voltage	zyHwMonitorPowerSupplyVoltageOutOfRange	1.3.6.1.4.1.890.1.15.3.26.2.3	This trap is sent when the voltage goes above or below the normal operating range.

Table 186 SNMP System Traps (continued)

OPTION	OBJECT LABEL	OBJECT ID	DESCRIPTION
reset	zySysMgmtUncontrolledSystemReset	1.3.6.1.4.1.890.1.15.3.49.2.1	This trap is sent when the Switch automatically resets.
	zySysMgmtControlledSystemReset	1.3.6.1.4.1.890.1.15.3.49.2.2	This trap is sent when the Switch resets by an administrator through a management interface.
	zySysMgmtBootImageInconsistence	1.3.6.1.4.1.890.1.15.3.49.2.3	This trap is sent when the index number of image which is loaded when the Switch starts up is different from what is specified via the CLI.
	RebootEvent	1.3.6.1.4.1.890.1.5.1.1.2	This trap is sent when the Switch reboots by an administrator through a management interface.
timesync	zyDateTimeTrapTimeServerNotReachable	1.3.6.1.4.1.890.1.15.3.82.3.1	This trap is sent when the Switch's date and time is not manually entered or the specified time server is not reachable.
	zyDateTimeTrapTimeServerNotReachableRecovered	1.3.6.1.4.1.890.1.15.3.82.3.2	This trap is sent when the Switch's real time clock is up to date.
intrusionlock	zyPortIntrusionLock	1.3.6.1.4.1.890.1.15.3.61.3.2	This trap is sent when intrusion lock occurs on a port.
loopguard	zyLoopGuardLoopDetect	1.3.6.1.4.1.890.1.15.3.45.2.1	This trap is sent when loopguard shuts down a port.
errdisable	zyErrdisableDetect	1.3.6.1.4.1.890.1.15.3.24.4.1	This trap is sent when an error is detected on a port, such as a loop occurs or the rate limit for specific control packets is exceeded.
	zyErrdisableRecovery	1.3.6.1.4.1.890.1.15.3.24.4.2	This trap is sent when the Switch ceases the action taken on a port, such as shutting down the port or discarding packets on the port, after the specified recovery interval.
poe (For PoE models only)	zyPoePowerPortOverload	1.3.6.1.4.1.890.1.15.3.59.4.1	This trap is sent when the port is turned off to supply power due to overloading.
	zyPoePowerPortShortCircuit	1.3.6.1.4.1.890.1.15.3.59.4.2	This trap is sent when the port is turned off to supply power due to short circuit.
	zyPoePowerPortOverSystemBudget	1.3.6.1.4.1.890.1.15.3.59.4.3	This trap is sent when the port is turned off to supply power because the requested power exceeds the total PoE power budget on the Switch.
	zyPoePowerPortOverloadRecovered	1.3.6.1.4.1.890.1.15.3.59.4.5	This trap is sent when the port is turned on to recover from an overloaded state.
	zyPoePowerPortShortCircuitRecovered	1.3.6.1.4.1.890.1.15.3.59.4.6	This trap is sent when the port is turned on to recover from a short circuit.
	zyPoePowerPortOverSystemBudgetRecovered	1.3.6.1.4.1.890.1.15.3.59.4.7	This trap is sent when the port is turned on to recover from an over system budget.
loginrecord	zyAccessControlLoginRecord	1.3.6.1.4.1.890.1.15.3.9.4.1	This trap is sent when users log in.
	zyAccessControlLogoutRecord	1.3.6.1.4.1.890.1.15.3.9.4.2	This trap is sent when users log out.
	zyAccessControlLoginFail	1.3.6.1.4.1.890.1.15.3.9.4.3	This trap is sent when users fail in login.

Table 187 SNMP Interface Traps

OPTION	OBJECT LABEL	OBJECT ID	DESCRIPTION
linkup	linkUp	1.3.6.1.6.3.1.1.5.4	This trap is sent when the Ethernet link is up.
linkdown	linkDown	1.3.6.1.6.3.1.1.5.3	This trap is sent when the Ethernet link is down.
autonegotiation	zyPortAutonegotiationFailed	1.3.6.1.4.1.890.1.15.3.61.3.1	This trap is sent when an Ethernet interface fails to auto-negotiate with the peer Ethernet interface.
lldp	lldpRemTablesChange	1.0.8802.1.1.2.0.0.1	The trap is sent when entries in the remote database have any updates. Link Layer Discovery Protocol (LLDP), defined as IEEE 802.1ab, enables LAN devices that support LLDP to exchange their configured settings. This helps eliminate configuration mismatch issues.
transceiver-ddm	zyTransceiverDdmiTemperatureOutOfRange	1.3.6.1.4.1.890.1.15.3.84.3.1	This trap is sent when the transceiver temperature is above or below the normal operating range.
	zyTransceiverDdmiTxPowerOutOfRange	1.3.6.1.4.1.890.1.15.3.84.3.2	This trap is sent when the transmitted optical power is above or below the normal operating range.
	zyTransceiverDdmiRxPowerOutOfRange	1.3.6.1.4.1.890.1.15.3.84.3.3	This trap is sent when the received optical power is above or below the normal operating range.
	zyTransceiverDdmiVoltageOutOfRange	1.3.6.1.4.1.890.1.15.3.84.3.4	This trap is sent when the transceiver supply voltage is above or below the normal operating range.
	zyTransceiverDdmiTxBiasOutOfRange	1.3.6.1.4.1.890.1.15.3.84.3.5	This trap is sent when the transmitter laser bias current is above or below the normal operating range.
	zyTransceiverDdmiTemperatureOutOfRangeRecovered	1.3.6.1.4.1.890.1.15.3.84.3.6	This trap is sent when the transceiver temperature is recovered from the out of normal operating range.
	zyTransceiverDdmiTxPowerOutOfRangeRecovered	1.3.6.1.4.1.890.1.15.3.84.3.7	This trap is sent when the transmitted optical power is recovered from the out of normal operating range.
	zyTransceiverDdmiRxPowerOutOfRangeRecovered	1.3.6.1.4.1.890.1.15.3.84.3.8	This trap is sent when the received optical power is recovered from the out of normal operating range.
	zyTransceiverDdmiVoltageOutOfRangeRecovered	1.3.6.1.4.1.890.1.15.3.84.3.9	This trap is sent when the transceiver supply voltage is recovered from the out of normal operating range.
	zyTransceiverDdmiTxBiasOutOfRangeRecovered	1.3.6.1.4.1.890.1.15.3.84.3.10	This trap is sent when the transmitter laser bias current is recovered from the out of normal operating range.
Storm-control	zyPortStormControlTrap	1.3.6.1.4.1.890.1.15.3.78.2.1	This trap is sent when storm control is detected on a specific port. A packet filter action has been applied on the interface.

Table 188 SNMP AAA Traps

OPTION	OBJECT LABEL	OBJECT ID	DESCRIPTION
authentication	authenticationFailure	1.3.6.1.6.3.1.1.5.5	This trap is sent when authentication fails due to incorrect user name and/or password.
	zyAaaAuthenticationFailure	1.3.6.1.4.1.890.1.15.3.8.3.1	This trap is sent when authentication fails due to incorrect user name and/or password.
	zyRadiusServerAuthenticationServerNotReachable	1.3.6.1.4.1.890.1.15.3.71.2.1	This trap is sent when there is no response message from the RADIUS authentication server.
	zyRadiusServerAuthenticationServerNotReachableRecovered	1.3.6.1.4.1.890.1.15.3.71.2.3	This trap is sent when there is a response message from the previously unreachable RADIUS authentication server.
authorization	zyAaaAuthorizationFailure	1.3.6.1.4.1.890.1.15.3.8.3.2	This trap is sent when management connection authorization failed.
accounting	zyRadiusServerAccountingServerNotReachable	1.3.6.1.4.1.890.1.15.3.71.2.2	This trap is sent when there is no response message from the RADIUS accounting server.
	zyRadiusServerAccountingServerNotReachableRecovered	1.3.6.1.4.1.890.1.15.3.71.2.4	This trap is sent when there is a response message from the previously unreachable RADIUS accounting server.

Table 189 SNMP IP Traps

OPTION	OBJECT LABEL	OBJECT ID	DESCRIPTION
ping	pingProbeFailed	1.3.6.1.2.1.80.0.1	This trap is sent when a single ping probe fails.
	pingTestFailed	1.3.6.1.2.1.80.0.2	This trap is sent when a ping test (consisting of a series of ping probes) fails.
	pingTestCompleted	1.3.6.1.2.1.80.0.3	This trap is sent when a ping test is completed.
traceroute	traceRouteTestFailed	1.3.6.1.2.1.81.0.2	This trap is sent when a traceroute test fails.
	traceRouteTestCompleted	1.3.6.1.2.1.81.0.3	This trap is sent when a traceroute test is completed.

Table 190 SNMP Switch Traps

OPTION	OBJECT LABEL	OBJECT ID	DESCRIPTION
stp	STPNewRoot	1.3.6.1.2.1.17.0.1	This trap is sent when the STP root switch changes.
	zyMrstpNewRoot	1.3.6.1.4.1.890.1.15.3.5 2.3.1	This trap is sent when the MRSTP root switch changes.
	zyMstpNewRoot	1.3.6.1.4.1.890.1.15.3.5 3.3.1	This trap is sent when the MSTP root switch changes.
	STPTopologyChange	1.3.6.1.2.1.17.0.2	This trap is sent when the STP topology changes.
	zyMrstpTopologyChange	1.3.6.1.4.1.890.1.15.3.5 2.3.2	This trap is sent when the MRSTP topology changes.
	zyMstpTopologyChange	1.3.6.1.4.1.890.1.15.3.5 3.3.2	This trap is sent when the MSTP root switch changes.
mactable	zyMacForwardingTableFull	1.3.6.1.4.1.890.1.15.3.4 8.2.1	This trap is sent when more than 99% of the MAC table is used.
	zyMacForwardingTableFullRecoverd	1.3.6.1.4.1.890.1.15.3.4 8.2.2	This trap is sent when the MAC address switching table has become normal from full.
rmon	RmonRisingAlarm	1.3.6.1.2.1.16.0.1	This trap is sent when a variable goes over the RMON "rising" threshold.
	RmonFallingAlarm	1.3.6.1.2.1.16.0.2	This trap is sent when the variable falls below the RMON "falling" threshold.
classifier	zyAcIV2ClassifierLogNotification	1.3.6.1.4.1.890.1.15.3.1 05.4.1	This trap is sent when the Switch detects classifier log information.
rip	zyRipExceedMaxDynamicRoute	1.3.6.1.4.1.890.1.15.3.7 4.2.1	This trap is sent when the maximum allowed number of dynamic routes learned through RIP has been exceeded.
ospf	zyOspfExceedMaxDynamicRoutePath	1.3.6.1.4.1.890.1.15.3.5 7.3.1	This trap is sent when the maximum allowed number of dynamic routes learned through OSPF has been exceeded.

42.7.2 SSH Overview

Unlike Telnet or FTP, which transmit data in clear text, SSH (Secure Shell) is a secure communication protocol that combines authentication and data encryption to provide secure encrypted communication between two hosts over an unsecured network.

Figure 273 SSH Communication Example



42.7.2.1 How SSH Works

The following table summarizes how a secure connection is established between two remote hosts.

Figure 274 How SSH Works

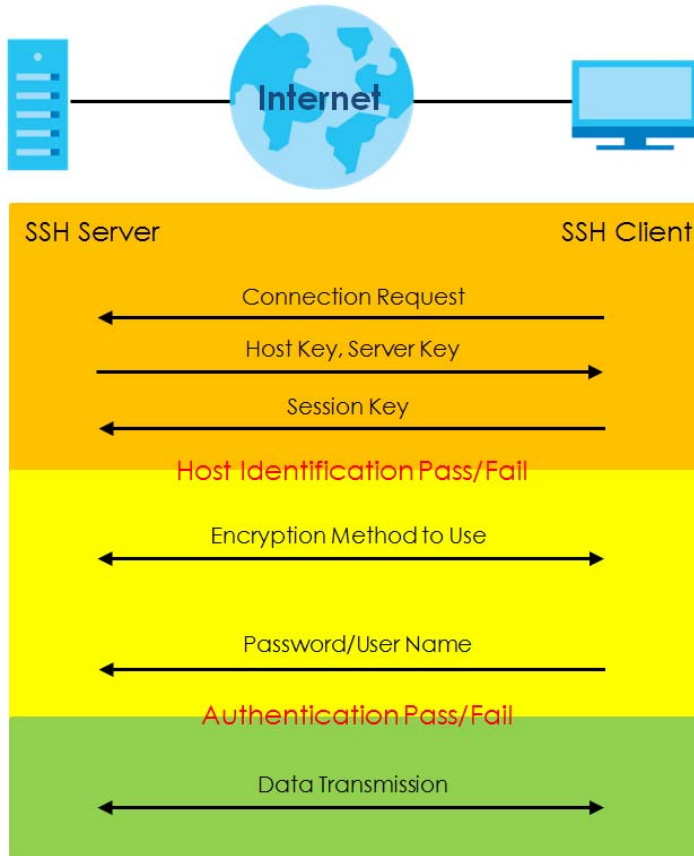

1 Host Identification

The SSH client sends a connection request to the SSH server. The server identifies itself with a host key. The client encrypts a randomly generated session key with the host key and server key and sends the result back to the server.

The client automatically saves any new server public keys. In subsequent connections, the server public key is checked against the saved version on the client computer.

2 Encryption Method

Once the identification is verified, both the client and server must agree on the type of encryption method to use.

3 Authentication and Data Transmission

After the identification is verified and data encryption activated, a secure tunnel is established between the client and the server. The client then sends its authentication information (user name and password) to the server to log in to the server.

42.7.2.2 SSH Implementation on the Switch

Your Switch supports SSH version 2 using RSA authentication and three encryption methods (DES, 3DES and Blowfish). The SSH server is implemented on the Switch for remote management and file transfer on port 22. Only one SSH connection is allowed at a time.

42.7.2.3 Requirements for Using SSH

You must install an SSH client program on a client computer (Windows or Linux operating system) that is used to connect to the Switch over SSH.

42.7.3 Introduction to HTTPS

HTTPS (HyperText Transfer Protocol over Secure Socket Layer, or HTTP over SSL) is a web protocol that encrypts and decrypts web pages. Secure Socket Layer (SSL) is an application-level protocol that enables secure transactions of data by ensuring confidentiality (an unauthorized party cannot read the transferred data), authentication (one party can identify the other party) and data integrity (you know if data has been changed).

It relies upon certificates, public keys, and private keys.

HTTPS on the Switch is used so that you may securely access the Switch using the Web Configurator. The SSL protocol specifies that the SSL server (the Switch) must always authenticate itself to the SSL client (the computer which requests the HTTPS connection with the Switch), whereas the SSL client only should authenticate itself when the SSL server requires it to do so. Authenticating client certificates is optional and if selected means the SSL-client must send the Switch a certificate. You must apply for a certificate for the browser from a Certificate Authority (CA) that is a trusted CA on the Switch.

Please refer to the following figure.

- 1 HTTPS connection requests from an SSL-aware web browser go to port 443 (by default) on the Switch's WS (web server).
- 2 HTTP connection requests from a web browser go to port 80 (by default) on the Switch's WS (web server).

Figure 275 HTTPS Implementation

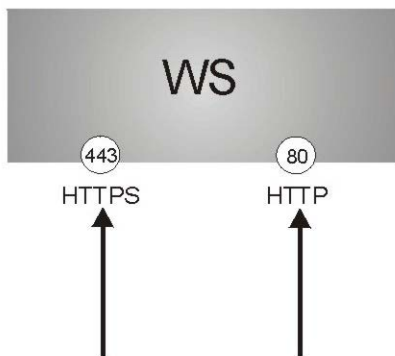

Note: If you disable HTTP in the Service Access Control screen, then the Switch blocks all HTTP connection attempts.

42.7.3.1 HTTPS Example

If you have not changed the default HTTPS port on the Switch, then in your browser enter "https://Switch IP Address/" as the web site address where "Switch IP Address" is the IP address or domain name of the Switch you wish to access.

Internet Explorer Warning Messages

Internet Explorer 6

When you attempt to access the Switch HTTPS server, a Windows dialog box pops up asking if you trust the server certificate.

You see the following **Security Alert** screen in Internet Explorer. Select **Yes** to proceed to the Web Configurator login screen; if you select **No**, then Web Configurator access is blocked.

Figure 276 Security Alert Dialog Box (Internet Explorer 6)



Internet Explorer 7 later version

When you attempt to access the Switch HTTPS server, a screen with the message "There is a problem with this website's security certificate." may display. If that is the case, click **Continue to this website (not recommended)** to proceed to the Web Configurator login screen.

Figure 277 Security Certificate Warning (Internet Explorer 11)

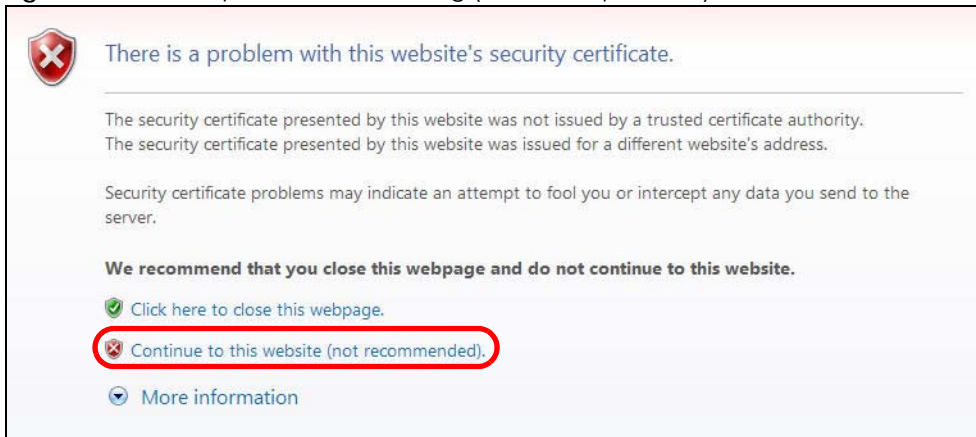

After you log in, you will see the red address bar with the message **Certificate Error**. Click on **Certificate Error** next to the address bar and click **View certificates**.

Figure 278 Certificate Error (Internet Explorer 11)

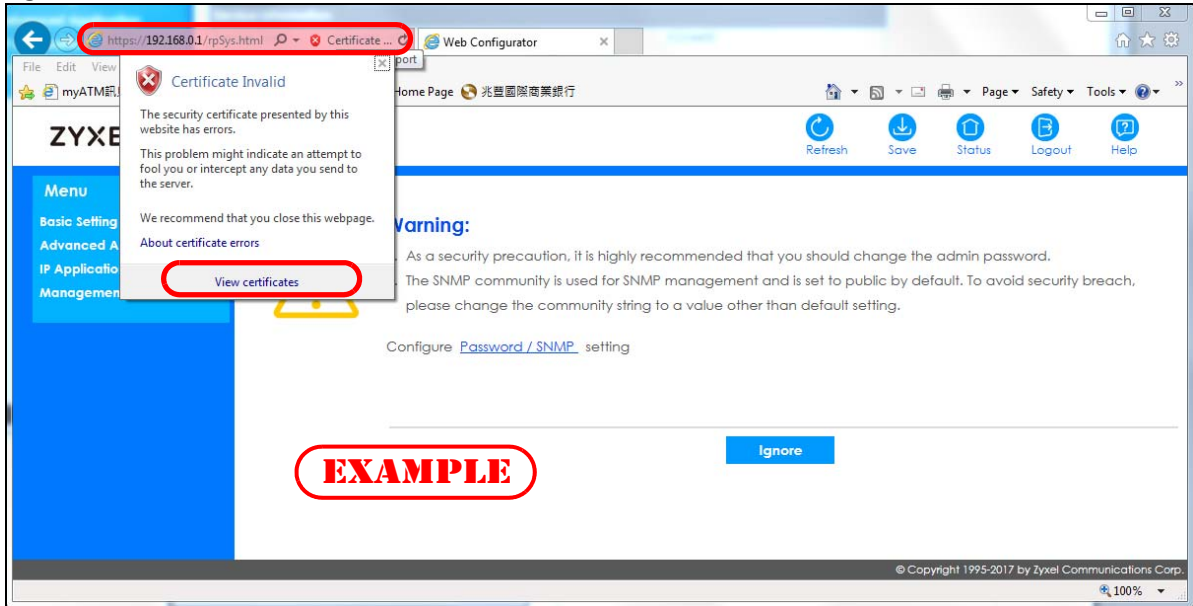

Click **Install Certificate...** and follow the on-screen instructions to install the certificate in your browser.

Figure 279 Certificate (Internet Explorer 11)

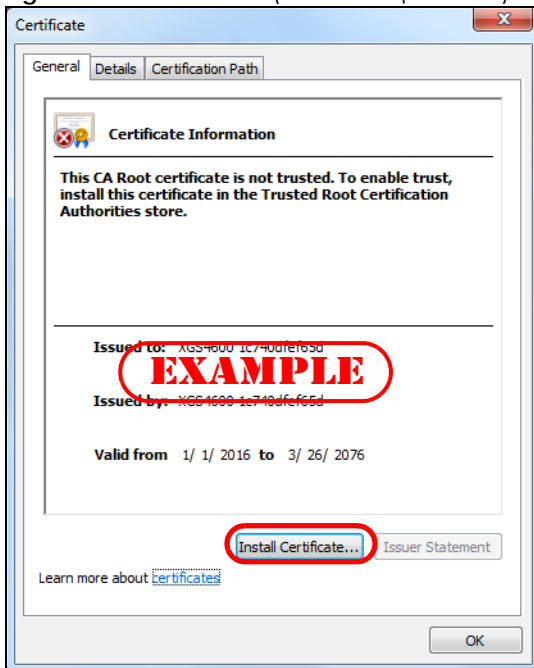

Mozilla Firefox Warning Messages

When you attempt to access the Switch HTTPS server, a **Your connection is not secure** screen may display. If that is the case, click **I Understand the Risks** and then the **Add Exception...** button.

Figure 280 Security Alert (Mozilla Firefox)

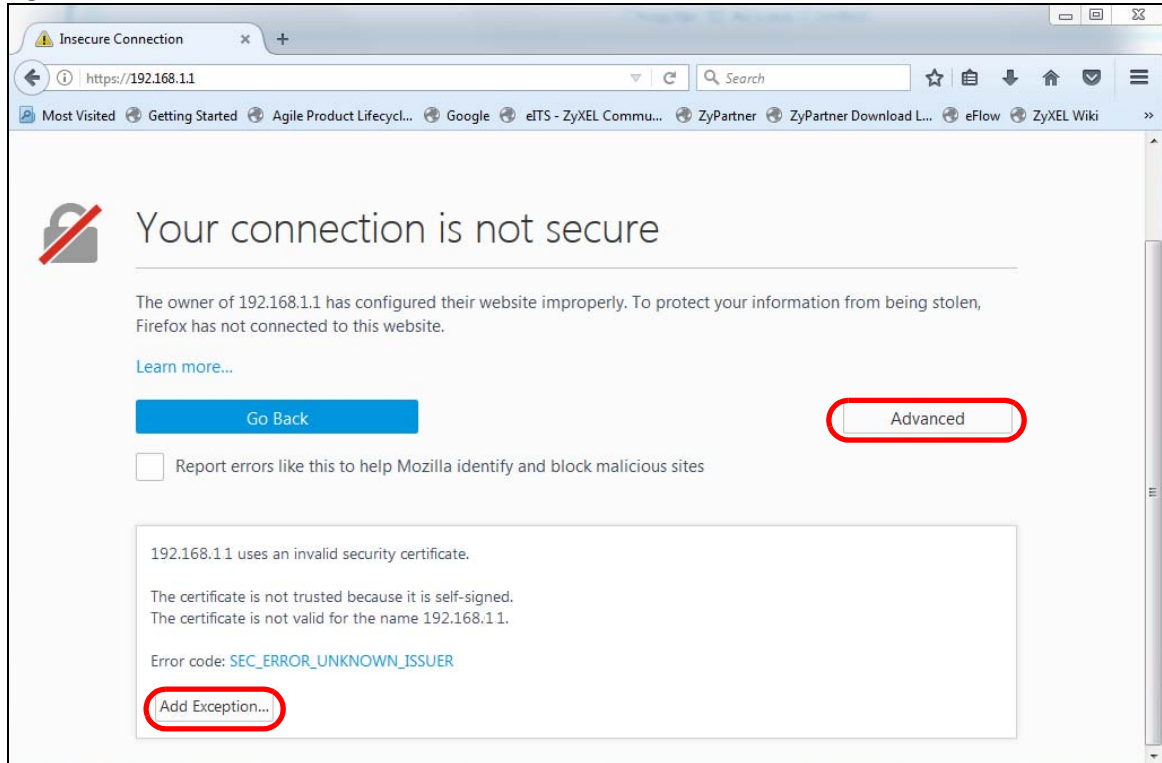

Confirm the HTTPS server URL matches. Click **Confirm Security Exception** to proceed to the Web Configurator login screen.

Figure 281 Security Alert (Mozilla Firefox)

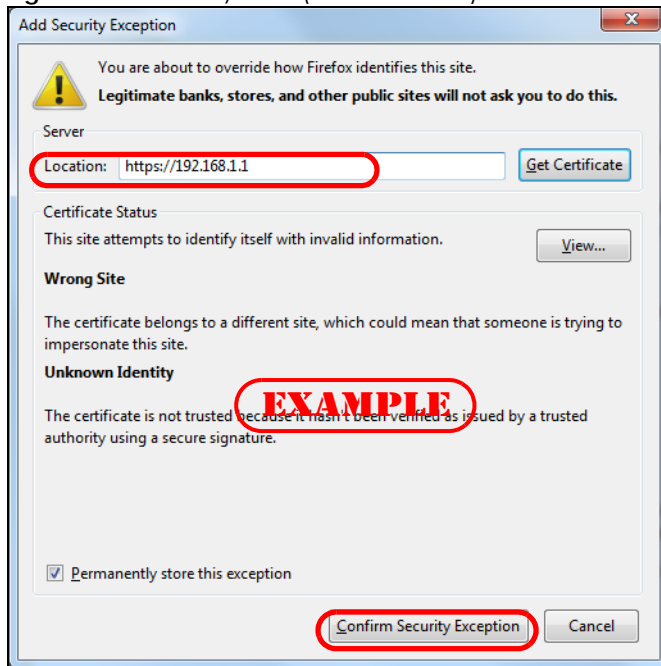

42.7.4 Google Chrome Warning Messages

When you attempt to access the Switch HTTPS server, a **Your connection is not private** screen may display. If that is the case, click **Advanced** and then **Proceed to x.x.x.x (unsafe)** to proceed to the Web Configurator login screen.

Figure 282 Security Alert (Google Chrome 58.0.3029.110)

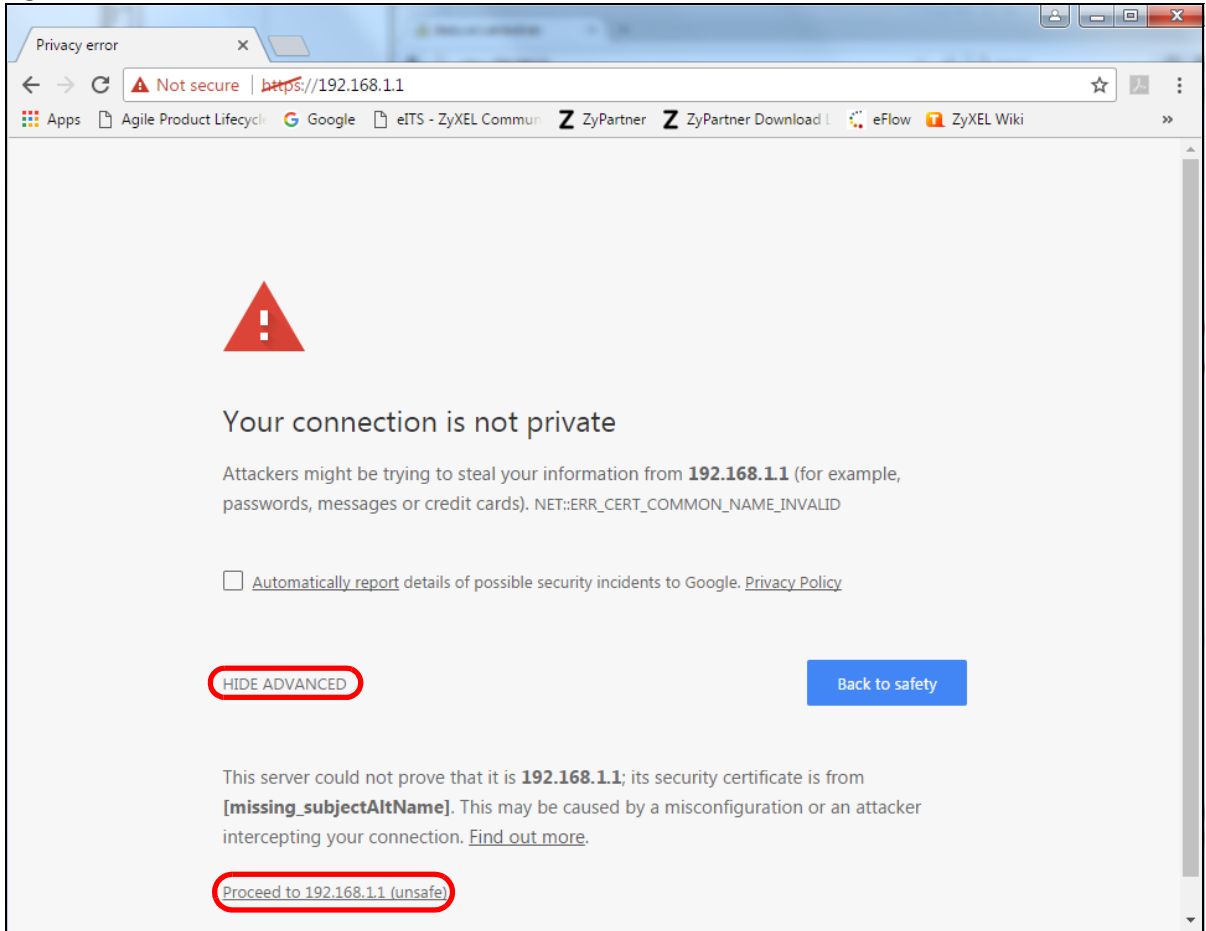

42.7.4.1 Main Settings

After you accept the certificate and enter the login username and password, the Switch main screen appears. The lock displayed in the bottom right of the browser status bar or next to the website address denotes a secure connection.

Figure 283 Example: Lock Denoting a Secure Connection

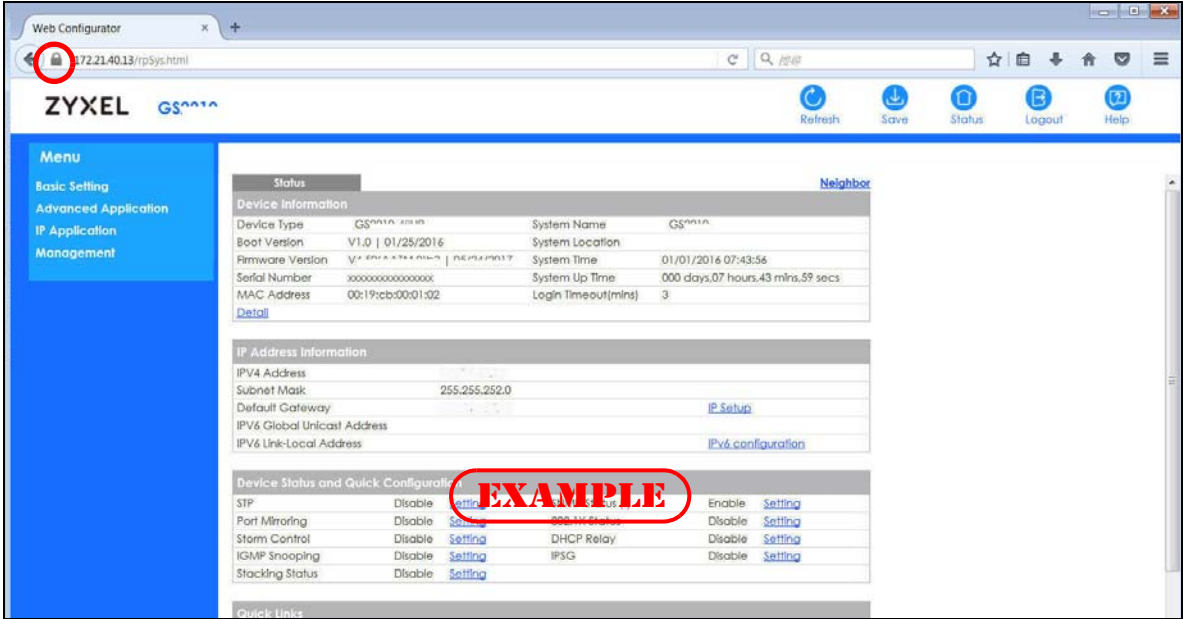

CHAPTER 43

Diagnostic

43.1 Overview

This chapter explains the **Diagnostic** screen. You can use this screen to help you identify problems.

43.2 Diagnostic

Click **Management > Diagnostic** in the navigation panel to open this screen. Use this screen to ping IP addresses, run a traceroute, perform port tests or show the Switch's location between devices.

Figure 284 Management > Diagnostic

The screenshot shows the 'Diagnostic' screen with a header bar and a large empty area labeled '- Info -'. Below this are several test configuration sections:

Ping Test	<input checked="" type="radio"/> IPv4	-		Ping
	<input type="radio"/> IPv6	-		
	IP Address/Host Name	<input type="text"/>		
	Count	<input type="text" value="3"/>		
Trace Route Test	<input checked="" type="radio"/> IPv4	-		Trace Route
	<input type="radio"/> IPv6	-		
	IP Address/Host Name	<input type="text"/>		
	TTL	<input type="text" value="30"/>		
	Wait Time	<input type="text" value="2"/>	Seconds	
	Queries	<input type="text" value="3"/>		
Ethernet Port Test	Port	<input type="text"/>		Port Test
Cable Diagnostics i	Port	<input type="text"/>		Diagnose
Locator LED	<input type="text" value="30"/>	Minutes	Blink Stop	

The following table describes the labels in this screen.

Table 191 Management > Diagnostic

LABEL	DESCRIPTION
Ping Test	
IPv4	Select this option if you want to ping an IPv4 address, and select vlan to specify the ID number of the VLAN to which the Switch is to send ping requests. Otherwise, select – to send ping requests to all VLANs on the Switch.
IPv6	Select this option if you want to ping an IPv6 address. You can also select vlan and specify the ID number of the VLAN to which the Switch is to send ping requests. Otherwise, select – to send ping requests to all VLANs on the Switch.
IP Address/Host Name	Type the IP address or host name of a device that you want to ping in order to test a connection. Click Ping to have the Switch ping the IP address.
Count	Enter the number of ICMP Echo Request (ping) messages the Switch continuously sends.
Trace Route Test	
IPv4	Select this option if you want to trace the route packets take to a device with an IPv4 address, and select vlan to specify the ID number of the VLAN on which the Switch traces the path. Otherwise, select – to trace the path on any VLAN. Note: The device to which you want to run a traceroute must belong to the VLAN you specify here.
IPv6	Select this option if you want to trace the route packets take to a device with an IPv6 address.
IP Address/Host Name	Enter the IP address or host name of a device to which you want to perform a traceroute. Click Trace Route to have the Switch perform the traceroute function. This determines the path a packet takes to the specified device.
TTL	Enter the Time To Live (TTL) value for the ICMP Echo Request packets. This is to set the maximum number of the hops (routers) a packet can travel through. Each router along the path will decrement the TTL value by one and forward the packets. When the TTL value becomes zero and the destination is not found, the router drops the packets and informs the sender.
Wait Time	Specify how many seconds the Switch waits for a response to a probe before running another traceroute.
Queries	Specify how many times the Switch performs the traceroute function.
Ethernet Port Test	Enter a port number and click Port Test to perform an internal loopback test.
Port	This is the number of the physical Ethernet port on the Switch.
Cable Diagnostics	Enter an Ethernet port number and click Diagnose to perform a physical wire-pair test of the Ethernet connections on the specified ports. The following fields display in the Diagnostic field when you diagnose a port. This field is available only on the Switch that has one or more copper Ethernet ports (except the MGMT port). Note: The Switch measures the cable length by sending an electric signal through the cable and reading the signal that is reflected back. To prevent possible interference from a connected device, it is suggested that you disconnect the other end of the Ethernet cable which is connected to the specified port.
Port	This is the number of the physical Ethernet port on the Switch.
Channel	An Ethernet cable usually has four pairs of wires. A 10BASE-T or 100BASE-TX port only use and test two pairs, while a 1000BASE-T port requires all four pairs. This displays the descriptive name of the wire-pair in the cable.

Table 191 Management > Diagnostic (continued)

LABEL	DESCRIPTION
Pair status	<p>Ok: The physical connection between the wire-pair is okay.</p> <p>Open: There is no physical connection (an open circuit detected) between the wire-pair.</p> <p>Short: There is an short circuit detected between the wire-pair.</p> <p>Unknown: The Switch failed to run cable diagnostics on the cable connected this port.</p> <p>Unsupported: The port is a fiber port or it is not active.</p>
Cable length	<p>This displays the total length of the Ethernet cable that is connected to the port when the Pair status is Ok and the Switch chipset supports this feature.</p> <p>This shows N/A if the Pair status is Open or Short. Check the Distance to fault.</p> <p>This shows Unsupported if the Switch chipset does not support to show the cable length.</p>
Distance to fault	<p>This displays the distance between the port and the location where the cable is open or shorted.</p> <p>This shows N/A if the Pair status is Ok.</p> <p>This shows Unsupported if the Switch chipset does not support to show the distance.</p>
Locator LED	<p>Enter a time interval (in minutes) and click Blink to show the actual location of the Switch between several devices in a rack.</p> <p>The default time interval is 30 minutes.</p> <p>Click Stop to have the Switch terminate the blinking locator LED.</p>

CHAPTER 44

System Log

44.1 Overview

A log message stores the information for viewing.

44.2 System Log

Click **Management > System Log** in the navigation panel to open this screen. Use this screen to check current system logs.

Note: When a log reaches the maximum number of log messages, new log messages automatically overwrite existing log messages, starting with the oldest existing log message first.

Figure 285 Management > System Log

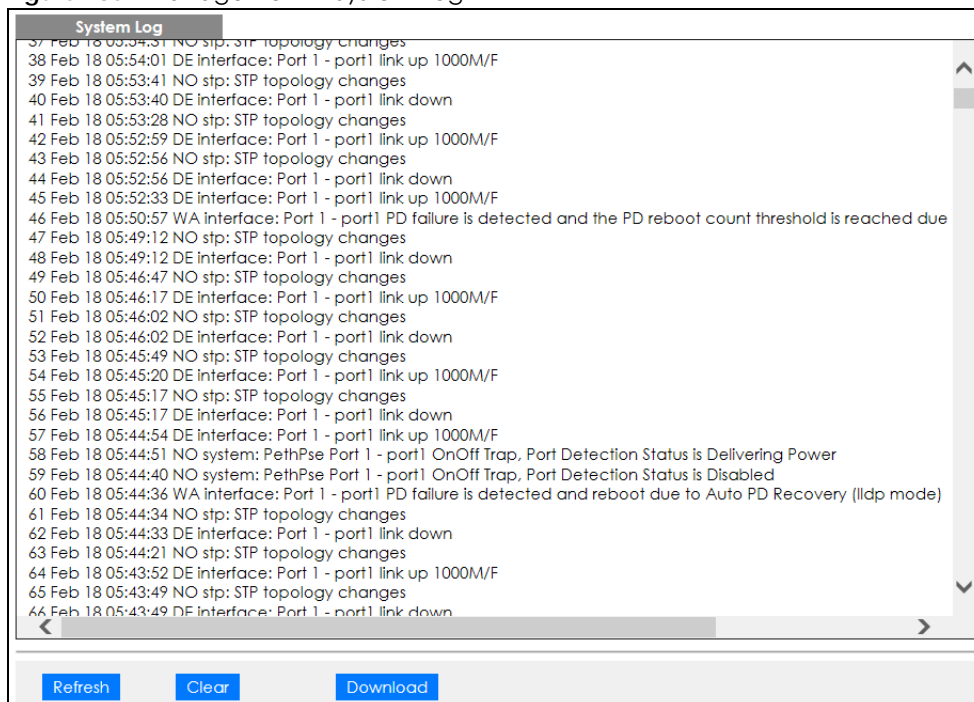

The summary table shows the time the log message was recorded and the reason the log message was generated. Click **Refresh** to update this screen. Click **Clear** to clear the whole log, regardless of what is currently displayed on the screen. Click **Download** to save the log to your computer.

CHAPTER 45

Syslog Setup

45.1 Syslog Overview

This chapter explains the syslog screens.

The syslog protocol allows devices to send event notification messages across an IP network to syslog servers that collect the event messages. A syslog-enabled device can generate a syslog message and send it to a syslog server.

Syslog is defined in RFC 3164. The RFC defines the packet format, content and system log related information of syslog messages. Each syslog message has a facility and severity level. The syslog facility identifies a file in the syslog server. Refer to the documentation of your syslog program for details. The following table describes the syslog severity levels.

Table 192 Syslog Severity Levels

CODE	SEVERITY
0	Emergency: The system is unusable.
1	Alert: Action must be taken immediately.
2	Critical: The system condition is critical.
3	Error: There is an error condition on the system.
4	Warning: There is a warning condition on the system.
5	Notice: There is a normal but significant condition on the system.
6	Informational: The syslog contains an informational message.
7	Debug: The message is intended for debug-level purposes.

45.1.1 What You Can Do

Use the **Syslog Setup** screen ([Section 45.2 on page 384](#)) to configure the device's system logging settings and configure a list of external syslog servers.

45.2 Syslog Setup

The syslog feature sends logs to an external syslog server. Use this screen to configure the device's system logging settings and configure a list of external syslog servers.

Click **Management > Syslog Setup** in the navigation panel to display this screen.

Figure 286 Management > Syslog Setup

Syslog Setup

Syslog Active

Logging type	Active	Facility
System	<input type="checkbox"/>	local use 0 ▼
Interface	<input type="checkbox"/>	local use 0 ▼
Switch	<input type="checkbox"/>	local use 0 ▼
AAA	<input type="checkbox"/>	local use 0 ▼
IP	<input type="checkbox"/>	local use 0 ▼

[Apply](#) [Cancel](#)

Syslog Server Setup

Active

Server Address

UDP Port

Log Level ▼

[Add](#) [Cancel](#) [Clear](#)

Index	Active	IP Address	UDP Port	Log Level
	<input type="checkbox"/>			

[Delete](#) [Cancel](#)

The following table describes the labels in this screen.

Table 193 Management > Syslog Setup

LABEL	DESCRIPTION
Syslog	Select Active to turn on syslog (system logging) and then configure the syslog setting.
Logging Type	This column displays the names of the categories of logs that the device can generate.
Active	Select this option to set the device to generate logs for the corresponding category.
Facility	The log facility allows you to send logs to different files in the syslog server. Refer to the documentation of your syslog program for more details.
Apply	Click Apply to save your changes to the Switch's run-time memory. The Switch loses these changes if it is turned off or loses power, so use the Save link on the top navigation panel to save your changes to the non-volatile memory when you are done configuring.
Cancel	Click Cancel to begin configuring this screen afresh.
Syslog Server Setup	
Active	Select this check box to have the device send logs to this syslog server. Clear the check box if you want to create a syslog server entry but not have the device send logs to it (you can edit the entry later).
Server Address	Enter the IPv4 or IPv6 address of the syslog server.
UDP Port	The default syslog server port is 514. If your syslog server uses a different port, configure the one it uses here.

Table 193 Management > Syslog Setup (continued)

LABEL	DESCRIPTION
Log Level	Select the severity levels of the logs that you want the device to send to this syslog server. The lower the number, the more critical the logs are.
Add	Click Add to save your changes to the Switch's run-time memory. The Switch loses these changes if it is turned off or loses power, so use the Save link on the top navigation panel to save your changes to the non-volatile memory when you are done configuring.
Cancel	Click Cancel to begin configuring this screen afresh.
Clear	Click Clear to return the fields to the factory defaults.
Index	This is the index number of a syslog server entry. Click this number to edit the entry.
Active	This field displays Yes if the device is to send logs to the syslog server. No displays if the device is not to send logs to the syslog server.
IP Address	This field displays the IP address of the syslog server.
UDP Port	This field displays the port of the syslog server.
Log Level	This field displays the severity level of the logs that the device is to send to this syslog server.
	Select an entry's check box to select a specific entry. Otherwise, select the check box in the table heading row to select all entries.
Delete	Click Delete to remove the selected entries.
Cancel	Click Cancel to begin configuring this screen afresh.

CHAPTER 46

Cluster Management

46.1 Cluster Management Overview

This chapter introduces cluster management.

Cluster Management allows you to manage switches through one Switch, called the cluster manager. The switches must be directly connected and be in the same VLAN group so as to be able to communicate with one another.

Table 194 Zyxel Clustering Management Specifications

Maximum number of cluster members	24
Cluster Member Models	Must be compatible with Zyxel cluster management implementation.
Cluster Manager	The Switch through which you manage the cluster member switches.
Cluster Members	The switches being managed by the cluster manager Switch.

In the following example, switch **A** in the basement is the cluster manager and the other switches on the upper floors of the building are cluster members.

Figure 287 Clustering Application Example

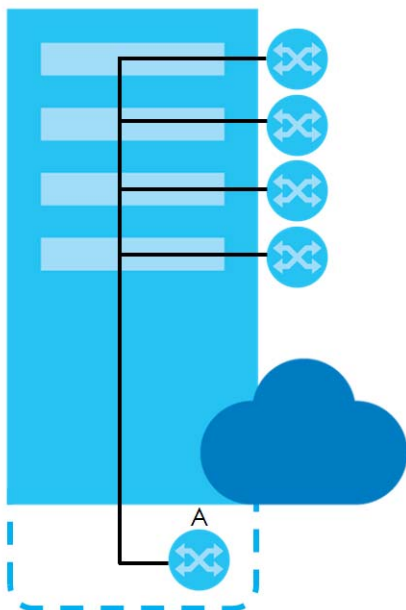

46.1.1 What You Can Do

- Use the **Cluster Management Status** screen ([Section 46.2 on page 388](#)) to view the role of the Switch within the cluster and to access a cluster member Switch's Web Configurator.
- Use the **Clustering Management Configuration** screen ([Section 46.3 on page 389](#)) to configure clustering management.

46.2 Cluster Management Status

Use this screen to view the role of the Switch within the cluster and to access a cluster member Switch's Web Configurator.

Click **Management > Cluster Management** in the navigation panel to display the following screen.

Note: A cluster can only have one manager.

Figure 288 Management > Cluster Management Status

Clustering Management Status		Configuration
Status	None	
Manager	00:00:00:00:00:00	
The Number Of Member = 0		
Index	MacAddr	Name
Model	Status	

The following table describes the labels in this screen.

Table 195 Management > Cluster Management Status

LABEL	DESCRIPTION
Status	This field displays the role of this Switch within the cluster. Manager Member (you see this if you access this screen in the cluster member Switch directly and not via the cluster manager) None (neither a manager nor a member of a cluster)
Manager	This field displays the cluster manager Switch's hardware MAC address.
The Number of Member	This field displays the number of switches that make up this cluster. The following fields describe the cluster member switches.
Index	You can manage cluster member switches via the cluster manager Switch. Each number in the Index column is a hyperlink leading to the cluster member Switch's Web Configurator.
MacAddr	This is the cluster member Switch's hardware MAC address.
Name	This is the cluster member Switch's System Name .

Table 195 Management > Cluster Management Status (continued)

LABEL	DESCRIPTION
Model	This field displays the model name.
Status	This field displays: Online (the cluster member Switch is accessible) Error (for example the cluster member Switch password was changed or the Switch was set as the manager and so left the member list, and so on) Offline (the Switch is disconnected – Offline shows approximately 1.5 minutes after the link between cluster member and manager goes down)

46.3 Clustering Management Configuration

Use this screen to configure clustering management. Click **Management > Cluster Management > Configuration** to display the next screen.

Figure 289 Management > Cluster Management > Configuration

Clustering Management Configuration [Status](#)

Clustering Manager

Active

Name

VID

[Apply](#) [Cancel](#)

Clustering Candidate

List

Password

[Add](#) [Cancel](#) [Refresh](#)

Index	MacAddr	Name	Model	<input type="checkbox"/>

[Remove](#) [Cancel](#)

The following table describes the labels in this screen.

Table 196 Management > Cluster Management > Configuration

LABEL	DESCRIPTION
Clustering Manager	The following fields relate to configuring the cluster manager.
Active	Select Active to have this Switch become the cluster manager switch. A cluster can only have one manager. Other (directly connected) switches that are set to be cluster managers will not be visible in the Clustering Candidates list. If a switch that was previously a cluster member is later set to become a cluster manager, then its Status is displayed as Error in the Cluster Management Status screen and a warning icon () appears in the member summary list below.
Name	Type a name to identify the Clustering Manager . You may use up to 32 printable characters (spaces are allowed).
VID	This is the VLAN ID and is only applicable if the Switch is set to 802.1Q VLAN. All switches must be directly connected and in the same VLAN group to belong to the same cluster. Switches that are not in the same VLAN group are not visible in the Clustering Candidates list. This field is ignored if the Clustering Manager is using Port-based VLAN.
Apply	Click Apply to save your changes to the Switch's run-time memory. The Switch loses these changes if it is turned off or loses power, so use the Save link on the top navigation panel to save your changes to the non-volatile memory when you are done configuring.
Cancel	Click Cancel to begin configuring this screen afresh.
Clustering Candidate	The following fields relate to the switches that are potential cluster members.
List	A list of suitable candidates found by auto-discovery is shown here. The switches must be directly connected. Directly connected switches that are set to be cluster managers will not be visible in the Clustering Candidate list. Switches that are not in the same management VLAN group will not be visible in the Clustering Candidate list.
Password	Each cluster member's password is its Web Configurator password. Select a member in the Clustering Candidate list and then enter its Web Configurator password. If that switch administrator changes the Web Configurator password afterwards, then it cannot be managed from the Cluster Manager . Its Status is displayed as Error in the Cluster Management Status screen. If multiple devices have the same password then hold [SHIFT] and click those switches to select them. Then enter their common Web Configurator password.
Add	Click Add to save your changes to the Switch's run-time memory. The Switch loses these changes if it is turned off or loses power, so use the Save link on the top navigation panel to save your changes to the non-volatile memory when you are done configuring.
Cancel	Click Cancel to begin configuring this screen afresh.
Refresh	Click Refresh to perform auto-discovery again to list potential cluster members.
The next summary table shows the information for the clustering members configured.	
Index	This is the index number of a cluster member switch.
MacAddr	This is the cluster member switch's hardware MAC address.
Name	This is the cluster member switch's System Name .
Model	This is the cluster member switch's model name.
	Select an entry's check box to select a specific entry. Otherwise, select the check box in the table heading row to select all entries.
Remove	Click the Remove button to remove the selected cluster member switches from the cluster.
Cancel	Click Cancel to begin configuring this screen afresh.

46.4 Technical Reference

This section provides technical background information on the topics discussed in this chapter.

46.4.1 Cluster Member Switch Management

Go to the **Clustering Management Status** screen of the cluster manager switch and then select an **Index** hyperlink from the list of members to go to that cluster member switch's Web Configurator home page. This cluster member Web Configurator home page and the home page that you would see if you accessed it directly are different.

Figure 290 Cluster Management: Cluster Member Web Configurator Screen

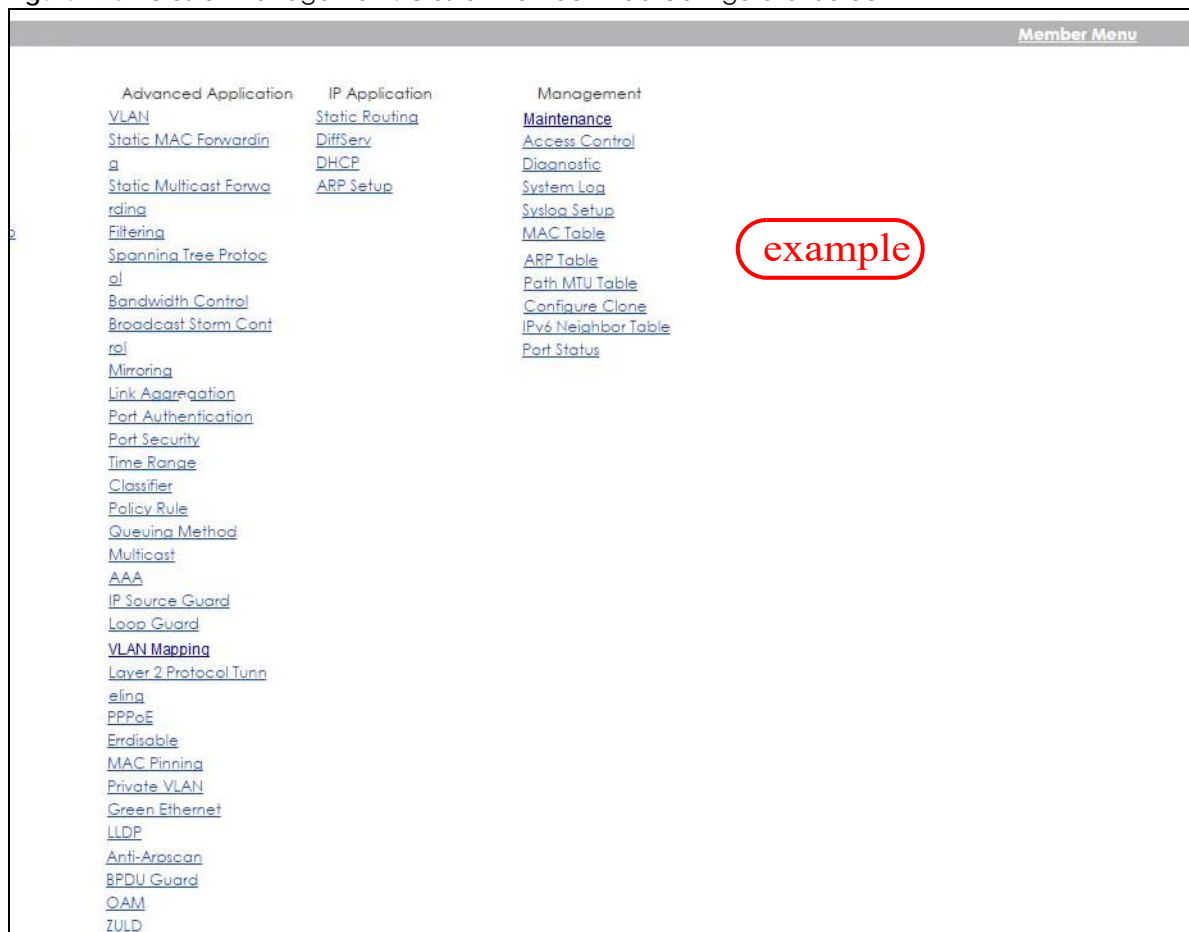

46.4.1.1 Uploading Firmware to a Cluster Member Switch

You can use FTP to upload firmware to a cluster member switch through the cluster manager switch as shown in the following example.

Figure 291 Example: Uploading Firmware to a Cluster Member Switch

```
C:\>ftp 192.168.1.1
Connected to 192.168.1.1.
220 Switch FTP version 1.0 ready at Thu Jan  1 00:58:46 1970
User (192.168.0.1:(none)): admin
331 Enter PASS command
Password:
230 Logged in
ftp> ls
200 Port command okay
150 Opening data connection for LIST
--w--w--w-  1 owner   group           3042210 Jul 01 12:00 ras
-rw-rw-rw-  1 owner   group           393216  Jul 01 12:00 config
--w--w--w-  1 owner   group              0 Jul 01 12:00 fw-00-a0-c5-01-23-46
-rw-rw-rw-  1 owner   group              0 Jul 01 12:00 config-00-a0-c5-01-23-46
226 File sent OK
ftp: 297 bytes received in 0.00Seconds 297000.00Kbytes/sec.
ftp> bin
200 Type I OK
ftp> put 460ABPI0.bin fw-00-a0-c5-01-23-46
200 Port command okay
150 Opening data connection for STOR fw-00-a0-c5-01-23-46
226 File received OK
ftp: 262144 bytes sent in 0.63Seconds 415.44Kbytes/sec.
ftp>
```

The following table explains some of the FTP parameters.

Table 197 FTP Upload to Cluster Member Example

FTP PARAMETER	DESCRIPTION
User	Enter "admin".
Password	The Web Configurator password default is 1234.
ls	Enter this command to list the name of cluster member switch's firmware and configuration file.
460ABPI0.bin	This is the name of the firmware file you want to upload to the cluster member switch.
fw-00-a0-c5-01-23-46	This is the cluster member switch's firmware name as seen in the cluster manager switch.
config-00-a0-c5-01-23-46	This is the cluster member switch's configuration file name as seen in the cluster manager switch.

CHAPTER 47

MAC Table

47.1 MAC Table Overview

This chapter introduces the **MAC Table** screen.

The **MAC Table** screen (a MAC table is also known as a filtering database) shows how frames are forwarded or filtered across the Switch's ports. It shows what device MAC address, belonging to what VLAN group (if any) is forwarded to which ports and whether the MAC address is dynamic (learned by the Switch) or static (manually entered in the **Static MAC Forwarding** screen).

47.1.1 What You Can Do

Use the **MAC Table** screen ([Section 47.2 on page 394](#)) to check whether the MAC address is dynamic or static.

47.1.2 What You Need to Know

The Switch uses the **MAC Table** to determine how to forward frames. See the following figure.

- 1 The Switch examines a received frame and learns the port on which this source MAC address came.
- 2 The Switch checks to see if the frame's destination MAC address matches a source MAC address already learned in the **MAC Table**.
 - If the Switch has already learned the port for this MAC address, then it forwards the frame to that port.
 - If the Switch has not already learned the port for this MAC address, then the frame is flooded to all ports. Too much port flooding leads to network congestion, then the Switch sends an ARP to request the MAC address. The Switch then learns the port that replies with the MAC address.
 - If the Switch has already learned the port for this MAC address, but the destination port is the same as the port it came in on, then it filters the frame.

Figure 292 MAC Table Flowchart

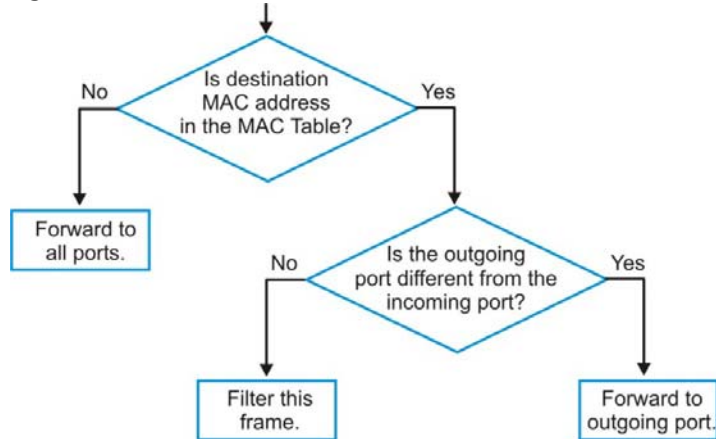

47.2 Viewing the MAC Table

Use this screen to search specific MAC addresses. You can also directly add dynamic MAC addresses into the static MAC forwarding table or MAC filtering table from the MAC table using this screen.

Click **Management > MAC Table** in the navigation panel to display the following screen.

Figure 293 Management > MAC Table

MAC table

Condition

Sort by

Transfer Type

All

Static

MAC

VID

Port

Trunk

MAC

Dynamic to MAC forwarding

Dynamic to MAC filtering

Index	MAC Address	VID	Port	Type
1	00:00:5e:00:01:02	1	3	Dynamic
2	00:03:21:10:be:00	1	3	Dynamic
3	00:03:21:10:f7:7c	1	3	Dynamic
4	00:03:21:10:f7:7d	1	3	Dynamic
5	00:03:21:11:02:a1	1	3	Dynamic
6	00:08:54:72:ad:bc	1	3	Dynamic
7	00:0e:e3:00:3d:0d	1	3	Dynamic
8	00:0e:e3:00:3d:48	1	3	Dynamic
9	00:0e:e3:01:75:e2	1	3	Dynamic
10	00:0e:e3:03:e5:e6	1	3	Dynamic

The following table describes the labels in this screen.

Table 198 Management > MAC Table

LABEL	DESCRIPTION
Condition	<p>Select one of the buttons and click Search to only display the data which matches the criteria you specified.</p> <p>Select All to display any entry in the MAC table of the Switch.</p> <p>Select Static to display the MAC entries manually configured on the Switch.</p> <p>Select MAC and enter a MAC address in the field provided to display a specified MAC entry.</p> <p>Select VID and enter a VLAN ID in the field provided to display the MAC entries belonging to the specified VLAN.</p> <p>Select Port and enter a port number in the field provided to display the MAC addresses which are forwarded on the specified port.</p> <p>Select Trunk and type the ID of a trunk group to display all MAC addresses learned from the ports in the trunk group.</p>
Sort by	<p>Define how the Switch displays and arranges the data in the summary table below.</p> <p>Select MAC to display and arrange the data according to MAC address.</p> <p>Select VID to display and arrange the data according to VLAN group.</p> <p>Select PORT to display and arrange the data according to port number.</p>
Transfer Type	<p>Select Dynamic to MAC forwarding and click the Transfer button to change all dynamically learned MAC address entries in the summary table below into static entries. They also display in the Static MAC Forwarding screen.</p> <p>Select Dynamic to MAC filtering and click the Transfer button to change all dynamically learned MAC address entries in the summary table below into MAC filtering entries. These entries will then display only in the Filtering screen and the default filtering action is Discard source.</p>
Search	Click this to search data in the MAC table according to your input criteria.
Transfer	Click this to perform the MAC address transferring you selected in the Transfer Type field.
Cancel	Click Cancel to change the fields back to their last saved values.
Index	This is the incoming frame index number.
MAC Address	This is the MAC address of the device from which this incoming frame came.
VID	This is the VLAN group to which this frame belongs.
Port	This is the port where the above MAC address is forwarded.
Type	This shows whether the MAC address is dynamic (learned by the Switch) or static (manually entered in the Static MAC Forwarding screen).

CHAPTER 48

ARP Table

48.1 Overview

This chapter introduces ARP Table.

Address Resolution Protocol (ARP) is a protocol for mapping an Internet Protocol address (IP address) to a physical machine address, also known as a Media Access Control or MAC address, on the local area network.

An IP (version 4) address is 32 bits long. In an Ethernet LAN, MAC addresses are 48 bits long. The ARP Table maintains an association between each MAC address and its corresponding IP address.

48.1.1 What You Can Do

Use the **ARP Table** screen ([Section 48.2 on page 396](#)) to view IP-to-MAC address mappings.

48.1.2 What You Need to Know

When an incoming packet destined for a host device on a local area network arrives at the Switch, the Switch's ARP program looks in the ARP Table and if it finds the address, it sends it to the device.

If no entry is found for the IP address, ARP broadcasts the request to all the devices on the LAN. The Switch fills in its own MAC and IP address in the sender address fields, and puts the known IP address of the target in the target IP address field. In addition, the Switch puts all ones in the target MAC field (FF.FF.FF.FF.FF.FF is the Ethernet broadcast address). The replying device (which is either the IP address of the device being sought or the router that knows the way) replaces the broadcast address with the target's MAC address, swaps the sender and target pairs, and unicasts the answer directly back to the requesting machine. ARP updates the ARP Table for future reference and then sends the packet to the MAC address that replied.

48.2 Viewing the ARP Table

Use the ARP table to view IP-to-MAC address mappings and remove specific dynamic ARP entries.

Click **Management > ARP Table** in the navigation panel to open the following screen.

Figure 294 Management > ARP Table

Index	IP Address	MAC Address	VID	Port	Age(s)	Type
1	10.214.80.44	dc:4a:3e:40:ec:67	1	20	220	dynamic

The following table describes the labels in this screen.

Table 199 Management > ARP Table

LABEL	DESCRIPTION
Condition	Specify how you want the Switch to remove ARP entries when you click Flush . Select All to remove all of the dynamic entries from the ARP table. Select IP Address and enter an IP address to remove the dynamic entries learned with the specified IP address. Select Port and enter a port number to remove the dynamic entries learned on the specified port.
Flush	Click Flush to remove the ARP entries according to the condition you specified.
Cancel	Click Cancel to return the fields to the factory defaults.
Index	This is the ARP table entry number.
IP Address	This is the IP address of a device connected to a Switch port with the corresponding MAC address below.
MAC Address	This is the MAC address of the device with the corresponding IP address above.
VID	This field displays the VLAN to which the device belongs.
Port	This field displays the port to which the device connects. CPU means this IP address is the Switch's management IP address.
Age(s)	This field displays how long (in seconds) an entry can still remain in the ARP table before it ages out and needs to be relearned. This shows 0 for a static entry.
Type	This shows the IP address is dynamic (learned by the Switch).

CHAPTER 49

Path MTU Table

49.1 Path MTU Overview

This chapter introduces the IPv6 Path MTU table.

The largest size (in bytes) of a packet that can be transferred over a data link is called the maximum transmission unit (MTU). The Switch uses Path MTU Discovery to discover Path MTU (PMTU), that is, the minimum link MTU of all the links in a path to the destination. If the Switch receives an ICMPv6 Packet Too Big error message after sending a packet, it fragments the next packet according to the suggested MTU in the error message.

49.2 Viewing the Path MTU Table

Use this screen to view IPv6 path MTU information on the Switch. Click **Management > Path MTU Table** in the navigation panel to display the screen as shown.

Figure 295 Management > Path MTU Table

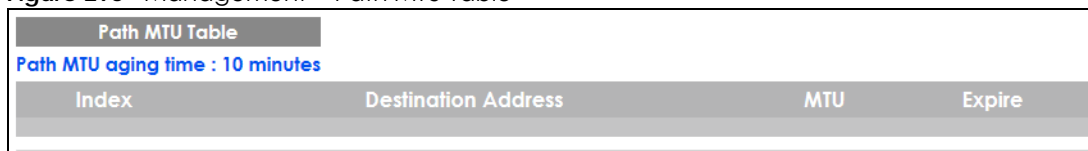

Index	Destination Address	MTU	Expire
-------	---------------------	-----	--------

The following table describes the labels in this screen.

Table 200 Management > Path MTU Table

LABEL	DESCRIPTION
Path MTU aging time	This field displays how long an entry remains in the Path MTU table before it ages out and needs to be relearned.
Index	This field displays the index number of each entry in the table.
Destination Address	This field displays the destination IPv6 address of each path or entry.
MTU	This field displays the maximum transmission unit of the links in the path.
Expire	This field displays how long (in minutes) an entry can still remain in the Path MTU table before it ages out and needs to be relearned.

CHAPTER 50

Configure Clone

50.1 Overview

This chapter shows you how you can copy the settings of one port onto other ports.

50.2 Configure Clone

Cloning allows you to copy the basic and advanced settings from a source port to a destination port or ports. Click **Management > Configure Clone** to open the following screen.

Figure 296 Management > Configure Clone

The screenshot shows the 'Configure Clone' configuration page. At the top, there are two input fields labeled 'Source' and 'Destination'. Below them is a 'Port Features' section. This section is divided into two categories: 'Basic Setting' and 'Advanced Application'. Each category contains a list of checkboxes for various port features. At the bottom of the page, there are 'Apply' and 'Cancel' buttons.

The following table describes the labels in this screen.

Table 201 Management > Configure Clone

LABEL	DESCRIPTION
Source/ Destination	Enter the source port under the Source label. This port's attributes are copied.
Port	Enter the destination port or ports under the Destination label. These are the ports which are going to have the same attributes as the source port. You can enter individual ports separated by a comma or a range of ports by using a dash. Example: 2, 4, 6 indicates that ports 2, 4 and 6 are the destination ports. 2-6 indicates that ports 2 through 6 are the destination ports.
Basic Setting	Select * to apply all settings to the port. Use this first to select the common settings and then remove the settings you do not want copied. Select which port settings (you configured in the Basic Setting menus) should be copied to the destination ports.

Table 201 Management > Configure Clone (continued)

LABEL	DESCRIPTION
Advanced Application	Select which port settings (you configured in the Advanced Application menus) should be copied to the destination ports.
Apply	Click Apply to save your changes to the Switch's run-time memory. The Switch loses these changes if it is turned off or loses power, so use the Save link on the top navigation panel to save your changes to the non-volatile memory when you are done configuring.
Cancel	Click Cancel to begin configuring this screen afresh.

CHAPTER 51

IPv6 Neighbor Table

51.1 IPv6 Neighbor Table Overview

This chapter introduces the IPv6 neighbor table.

An IPv6 host is required to have a neighbor table. If there is an address to be resolved or verified, the Switch sends out a neighbor solicitation message. When the Switch receives a neighbor advertisement in response, it stores the neighbor's link-layer address in the neighbor table. You can also manually create a static IPv6 neighbor entry using the **Basic Setting > IPv6 > IPv6 Configuration > IPv6 Neighbor Setup** screen.

When the Switch needs to send a packet, it first consults other table to determine the next hop. Once the next hop IPv6 address is known, the Switch looks into the neighbor table to get the link-layer address and sends the packet when the neighbor is reachable. If the Switch cannot find an entry in the neighbor table or the state for the neighbor is not reachable, it starts the address resolution process. This helps reduce the number of IPv6 solicitation and advertisement messages.

51.2 Viewing the IPv6 Neighbor Table

Use this screen to view IPv6 neighbor information on the Switch. Click **Management > IPv6 Neighbor Table** in the navigation panel to display the screen as shown.

Figure 297 Management > IPv6 Neighbor Table

IPv6 Neighbor Table					
Sort by:					
Address		MAC		Interface	
Index	Address	MAC	Status	Type	Interface

The following table describes the labels in this screen.

Table 202 Management > IPv6 Neighbor Table

LABEL	DESCRIPTION
Sort by	Select this to display and arrange the data according to IPv6 address (Address), MAC address (MAC) or IPv6 interface (Interface). The information is then displayed in the summary table below.
Index	This field displays the index number of each entry in the table.
Address	This field displays the IPv6 address of the Switch or a neighboring device.
MAC	This field displays the MAC address of the IPv6 interface on which the IPv6 address is configured or the MAC address of the neighboring device.

Table 202 Management > IPv6 Neighbor Table (continued)

LABEL	DESCRIPTION
Status	<p>This field displays whether the neighbor IPv6 interface is reachable. In IPv6, "reachable" means an IPv6 packet can be correctly forwarded to a neighbor node (host or router) and the neighbor can successfully receive and handle the packet. The available options in this field are:</p> <ul style="list-style-type: none"> • reachable (R): The interface of the neighboring device is reachable. (The Switch has received a response to the initial request.) • stale (S): The last reachable time has expired and the Switch is waiting for a response to another initial request. The field displays this also when the Switch receives an unrequested response from the neighbor's interface. • delay (D): The neighboring interface is no longer known to be reachable, and traffic has been sent to the neighbor recently. The Switch delays sending request packets for a short to give upper-layer protocols a chance to determine reachability. • probe (P): The Switch is sending request packets and waiting for the neighbor's response. • invalid (IV): The neighbor address is with an invalid IPv6 address. • unknown (?): The status of the neighboring interface cannot be determined for some reason. • incomplete (I): Address resolution is in progress and the link-layer address of the neighbor has not yet been determined. The interface of the neighboring device did not give a complete response.
Type	<p>This field displays the type of an address mapping to a neighbor interface. The available options in this field are:</p> <ul style="list-style-type: none"> • other (O): none of the following type. • local (L): A Switch interface is using the address. • dynamic (D): The IP address to MAC address can be successfully resolved using IPv6 Neighbor Discovery protocol. Is it similar as IPv4 ARP (Address Resolution protocol). • static (S): The interface address is statically configured.
Interface	<p>This field displays the ID number of the IPv6 interface on which the IPv6 address is created or through which the neighboring device can be reached.</p>

CHAPTER 52

Port Status

52.1 Overview

This chapter introduces the port status screens.

52.2 Port Status

This screen displays a port statistical summary with links to each port showing statistical details. To view the port statistics, click **Status** in all Web Configurator screens and then the **Port Status** link in the **Quick Links** section of the **Status** screen to display the **Port Status** screen as shown next. You can also click **Management > Port Status** to see the following screen.

Figure 298 Port Status

Port Status											DDMI	Utilization
Port	Name	Link	State	PD	LACP	TxPkts	RxPkts	Errors	Tx kB/s	Rx kB/s	Up Time	
1		Down	STOP	Off	Disabled	0	0	0	0.0	0.0	0:00:00	
2		Down	STOP	Off	Disabled	0	0	0	0.0	0.0	0:00:00	
3		1G/F	FORWARDING	Off	Disabled	79888	31771	0	0.749	0.706	1:03:51	
4		Down	STOP	Off	Disabled	0	0	0	0.0	0.0	0:00:00	
5		100M/F	FORWARDING	Off	Disabled	29270	77169	0	0.706	0.749	1:03:46	
6		Down	STOP	Off	Disabled	0	0	0	0.0	0.0	0:00:00	
7		Down	STOP	Off	Disabled	0	0	0	0.0	0.0	0:00:00	
8		Down	STOP	Off	Disabled	0	0	0	0.0	0.0	0:00:00	
9		Down	STOP	Off	Disabled	0	0	0	0.0	0.0	0:00:00	

Any
 Port

The following table describes the labels in this screen.

Table 203 Management > Port Status

LABEL	DESCRIPTION
Port	This identifies the Ethernet port. Click a port number to display the Port Details screen.
Name	This is the name you assigned to this port in the Basic Setting > Port Setup screen.
Link	This field displays the speed (either 10M for 10 Mbps, 100M for 100 Mbps, or 1G for 1 Gbps) and the duplex (F for full duplex or H for half). It also shows the cable type (Copper or Fiber) for the combo ports. This field displays Down if the port is not connected to any device.
State	<p>If STP (Spanning Tree Protocol) is enabled, this field displays the STP state of the port.</p> <p>If STP is disabled, this field displays FORWARDING if the link is up, otherwise, it displays STOP.</p> <p>When LACP (Link Aggregation Control Protocol) and STP are in blocking state, it displays Blocking.</p>

Table 203 Management > Port Status (continued)

LABEL	DESCRIPTION
PD	For PoE models only. This field displays whether or not a powered device (PD) is allowed to receive power from the Switch on this port.
LACP	This field displays whether LACP (Link Aggregation Control Protocol) has been enabled on the port.
TxPkts	This field shows the number of transmitted frames on this port.
RxPkts	This field shows the number of received frames on this port.
Errors	This field shows the number of received errors on this port.
Tx KB/s	This field shows the number of kilobytes per second transmitted on this port.
Rx KB/s	This field shows the number of kilobytes per second received on this port.
Up Time	This field shows the total amount of time in hours, minutes and seconds the port has been up.
Clear Counter	Select Port , enter a port number and then click Clear Counter to erase the recorded statistical information for that port, or select Any to clear statistics for all ports.

52.2.1 Port Details

Click a number in the **Port** column in the **Port Status** screen to display individual port statistics. Use this screen to check status and detailed performance data about an individual port on the Switch.

Figure 299 Management > Port Status > Port Details

Port Details		Port Status
Port Info	Port NO.	1
	Name	port1
	Link	1G/F
	State	FORWARDING
	LACP	Disabled
	TxPkts	542623
	RxPkts	36878
	Errors	0
	Tx kB/s	0.589
	Tx Utilization%	0.0
	Rx kB/s	0.344
	Rx Utilization%	0.0
	Up Time	23:54:17
TX Packet	Unicast	25796
	Multicast	242370
	Broadcast	274457
	Pause	0
RX Packet	Unicast	18823
	Multicast	2885
	Broadcast	15170
	Pause	0
TX Collision	Single	0
	Multiple	0
	Excessive	0
	Late	0
Error Packet	RX CRC	0
	Length	0
	Runt	0
Distribution	64	351136
	65 to 127	88882
	128 to 255	74678
	256 to 511	29626
	512 to 1023	35168
	1024 to 1518	11
	Giant	0

The following table describes the labels in this screen.

Table 204 Management > Port Status > Port Details

LABEL	DESCRIPTION
Port Info	
Port NO.	This field displays the port number you are viewing.
Name	This field displays the name of the port.
Link	This field displays the speed (either 10M for 10 Mbps, 100M for 100 Mbps, or 1G for 1 Gbps) and the duplex (F for full duplex or H for half duplex). It also shows the cable type (Copper or Fiber) for the combo ports. This field displays Down if the port is not connected to any device.
State	If STP (Spanning Tree Protocol) is enabled, this field displays the STP state of the port. If STP is disabled, this field displays FORWARDING if the link is up, otherwise, it displays STOP . When LACP (Link Aggregation Control Protocol), STP, and dot1x are in blocking state, it displays Blocking .

Table 204 Management > Port Status > Port Details (continued)

LABEL	DESCRIPTION
LACP	This field shows if LACP is enabled on this port or not.
TxPkts	This field shows the number of transmitted frames on this port.
RxPkts	This field shows the number of received frames on this port.
Errors	This field shows the number of received errors on this port.
Tx kB/s	This field shows the number of kilobytes per second transmitted on this port.
Tx Utilization%	This field shows the percentage of actual transmitted frames on this port as a percentage of the Link speed.
Rx kB/s	This field shows the number of kilobytes per second received on this port.
Rx Utilization%	This field shows the percentage of actual received frames on this port as a percentage of the Link speed.
Up Time	This field shows the total amount of time the connection has been up.
Tx Packet	
The following fields display detailed information about packets transmitted.	
Unicast	This field shows the number of good unicast packets transmitted.
Multicast	This field shows the number of good multicast packets transmitted.
Broadcast	This field shows the number of good broadcast packets transmitted.
Pause	This field shows the number of 802.3x pause packets transmitted.
Rx Packet	
The following fields display detailed information about packets received.	
Unicast	This field shows the number of good unicast packets received.
Multicast	This field shows the number of good multicast packets received.
Broadcast	This field shows the number of good broadcast packets received.
Pause	This field shows the number of 802.3x pause packets received.
TX Collision	
The following fields display information on collisions while transmitting.	
Single	This is a count of successfully transmitted packets for which transmission is inhibited by exactly one collision.
Multiple	This is a count of successfully transmitted packets for which transmission was inhibited by more than one collision.
Excessive	This is a count of packets for which transmission failed due to excessive collisions. Excessive collision is defined as the number of maximum collisions before the retransmission count is reset.
Late	This is the number of times a late collision is detected, that is, after 512 bits of the packets have already been transmitted.
Error Packet	
The following fields display detailed information about packets received that were in error.	
RX CRC	This field shows the number of packets received with CRC (Cyclic Redundant Check) errors.
Length	This field shows the number of packets received with a length that was out of range.
Runt	This field shows the number of packets received that were too short (shorter than 64 octets), including the ones with CRC errors.
Distribution	
64	This field shows the number of packets (including bad packets) received that were 64 octets in length.
65 to 127	This field shows the number of packets (including bad packets) received that were between 65 and 127 octets in length.

Table 204 Management > Port Status > Port Details (continued)

LABEL	DESCRIPTION
128 to 255	This field shows the number of packets (including bad packets) received that were between 128 and 255 octets in length.
256 to 511	This field shows the number of packets (including bad packets) received that were between 256 and 511 octets in length.
512 to 1023	This field shows the number of packets (including bad packets) received that were between 512 and 1023 octets in length.
1024 to 1518	This field shows the number of packets (including bad packets) received that were between 1024 and 1518 octets in length.
Giant	This field shows the number of packets (including bad packets) received that were between 1519 octets and the maximum frame size. The maximum frame size varies depending on your switch model.

52.2.2 DDMI

The optical SFP transceiver's support for the Digital Diagnostics Monitoring Interface (DDMI) function lets you monitor the transceiver's parameters to perform component monitoring, fault isolation and failure prediction tasks. This allows proactive, preventative network maintenance to help ensure service continuity.

Use this screen to view the DDMI status of the Switch's SFP transceivers. Click **Management > Port Status > DDMI** to see the following screen. Alternatively, click **Status** from any Web Configurator screen and then the **Port Status** link in the **Quick Links** section of the **Status** screen to display the **Port Status** screen and then click the **DDMI** link tab.

Figure 300 Management > Port Status > DDMI

DDMI						Port Status
Port	Vendor	Part Number	Serial Number	Revision	Date Code	Transceiver
45	-	-	-	-	-	-
46	-	-	-	-	-	-
47	-	-	-	-	-	-
48	-	-	-	-	-	-
49	-	-	-	-	-	-
50	-	-	-	-	-	-

The following table describes the labels in this screen.

Table 205 Management > Port Status > DDMI

LABEL	DESCRIPTION
Port	This identifies the SFP port.
Vendor	This displays the vendor name of the optical transceiver.
Part Number	This displays the part number of the optical transceiver.
Serial Number	This displays the serial number of the optical transceiver.
Revision	This displays the revision number of the optical transceiver.
Date Code	This displays the date when the optical transceiver was manufactured.
Transceiver	This displays whether the connection to the optical network is up or down.

52.2.3 DDMI Details

Use this screen to view the real-time SFP (Small Form Factor Pluggable) transceiver information and operating parameters on the SFP port. The parameters include, for example, transmitting and receiving power, and module temperature.

Click a number in the **Port** column in the **DDMI** screen to view current transceivers' status.

Figure 301 Management > Port Status > DDMI > DDMI Details

DDMI Details						DDMI
Transceiver Information						
Port No: 6						
Connector Type	-					
Vendor	-					
Part Number	-					
Serial Number	-					
Revision	-					
Date Code	-					
Transceiver	-					
DDMI Information						
Type	Current	High Alarm Threshold	High Warn Threshold	Low Warn Threshold	Low Alarm Threshold	
Temperature(C)	-	-	-	-	-	
Voltage(V)	-	-	-	-	-	
TX Bias(mA)	-	-	-	-	-	
TX Power(dbm)	-	-	-	-	-	
RX Power(dbm)	-	-	-	-	-	

The following table describes the labels in this screen.

Table 206 Management > Port Status > DDMI > DDMI Details

LABEL	DESCRIPTION
Transceiver Information	
Port No	This identifies the SFP port.
Connector Type	This displays the connector type of the optical transceiver.
Vendor	This displays the vendor name of the optical transceiver.
Part Number	This displays the part number of the optical transceiver.
Serial Number	This displays the serial number of the optical transceiver.
Revision	This displays the revision number of the optical transceiver.
Date Code	This displays the date when the optical transceiver was manufactured.
Transceiver	This displays details about the type of transceiver installed in the SFP slot.
Calibration	This field is available only when an SFP transceiver is inserted into the SFP slot. Internal displays if the measurement values are calibrated by the transceiver. External displays if the measurement values are raw data which the Switch calibrates.
DDMI Information	
Type	This displays the DDMI parameter.
Temperature (C/F)	This displays the temperature inside the SFP transceiver in degrees Celsius or Fahrenheit.

Table 206 Management > Port Status > DDMI > DDMI Details (continued)

LABEL	DESCRIPTION
Voltage (V)	This displays the level of voltage being supplied to the SFP transceiver.
TX Bias (mA)	This displays the milliamps (mA) being supplied to the SFP transceiver's Laser Diode Transmitter.
TX Power (dbm)	This displays the amount of power the SFP transceiver is transmitting.
RX Power (dbm)	This displays the amount of power the SFP transceiver is receiving from the fiber cable.
Current	This displays the current status for each monitored DDMI parameter.
High Alarm Threshold	This displays the high value alarm threshold for each monitored DDMI parameter. An alarm signal is reported to the Switch if the monitored DDMI parameter reaches this value.
High Warn Threshold	This displays the high value warning threshold for each monitored DDMI parameter. A warning signal is reported to the Switch if the monitored DDMI parameter reaches this value.
Low Warn Threshold	This displays the low value warning threshold for each monitored DDMI parameter. A warning signal is reported to the Switch if the monitored DDMI parameter reaches this value.
Low Alarm Threshold	This displays the low value alarm threshold for each monitored DDMI parameter. An alarm signal is reported to the Switch if the monitored DDMI parameter reaches this value.

52.2.4 Port Utilization

This screen displays the percentage of actual transmitted or received frames on a port as a percentage of the **Link** speed. To view port utilization, click **Management > Port Status > Port Utilization** to see the following screen. Alternatively, click **Status** from any Web Configurator screen and then the **Port Status** link in the **Quick Links** section of the **Status** screen to display the **Port Status** screen and then click the **Utilization** link tab.

Figure 302 Management > Port Status > Utilization

Port Utilization					Port Status	
Port	Link	Tx kB/s	Tx Utilization%	Rx kB/s	Rx Utilization%	
1	Down	0.0	0.0	0.0	0.0	
2	Down	0.0	0.0	0.0	0.0	
3	Down	0.0	0.0	0.0	0.0	
4	Down	0.0	0.0	0.0	0.0	
5	Down	0.0	0.0	0.0	0.0	
6	Down	0.0	0.0	0.0	0.0	
7	Down	0.0	0.0	0.0	0.0	
8	Down	0.0	0.0	0.0	0.0	
9	Down	0.0	0.0	0.0	0.0	
10	Down	0.0	0.0	0.0	0.0	
11	Down	0.0	0.0	0.0	0.0	
12	Down	0.0	0.0	0.0	0.0	
13	Down	0.0	0.0	0.0	0.0	
14	Down	0.0	0.0	0.0	0.0	
15	Down	0.0	0.0	0.0	0.0	
16	Down	0.0	0.0	0.0	0.0	
17	Down	0.0	0.0	0.0	0.0	
18	1G/F	0.55	0.0	0.164	0.0	
19	Down	0.0	0.0	0.0	0.0	
20	1G/F	0.164	0.0	0.55	0.0	
21	Down	0.0	0.0	0.0	0.0	
22	Down	0.0	0.0	0.0	0.0	
23	Down	0.0	0.0	0.0	0.0	
24	Down	0.0	0.0	0.0	0.0	
25	Down	0.0	0.0	0.0	0.0	
26	Down	0.0	0.0	0.0	0.0	
27	Down	0.0	0.0	0.0	0.0	
28	Down	0.0	0.0	0.0	0.0	

The following table describes the labels in this screen.

Table 207 Management > Port Status > Utilization

LABEL	DESCRIPTION
Port	This identifies the Ethernet port.
Link	This field displays the speed (either 10M for 10 Mbps, 100M for 100 Mbps, or 1G for 1 Gbps) and the duplex (F for full duplex). It also shows the cable type (Copper or Fiber) for the combo ports. This field displays Down if the port is not connected to any device.
Tx kB/s	This field shows the transmission speed of data sent on this port in kilobytes per second.
Tx Utilization%	This field shows the percentage of actual transmitted frames on this port as a percentage of the Link speed.
Rx KB/s	This field shows the transmission speed of data received on this port in kilobytes per second.
Rx Utilization%	This field shows the percentage of actual received frames on this port as a percentage of the Link speed.

PART III

Troubleshooting and Appendices

CHAPTER 53

Troubleshooting

This chapter offers some suggestions to solve problems you might encounter. The potential problems are divided into the following categories.

- [Power, Hardware Connections, and LEDs](#)
- [Switch Access and Login](#)
- [Switch Configuration](#)

53.1 Power, Hardware Connections, and LEDs

[The Switch does not turn on. None of the LEDs turn on.](#)

- 1 Make sure the Switch is turned on.
- 2 Make sure you are using the power adapter or cord included with the Switch.
- 3 Make sure the power adapter or cord is connected to the Switch and plugged in to an appropriate power source. Make sure the power source is turned on.
- 4 Turn the Switch off and on.
- 5 Disconnect and re-connect the power adapter or cord to the Switch.
- 6 If the problem continues, contact the vendor.

[One of the LEDs does not behave as expected.](#)

- 1 Make sure you understand the normal behavior of the LED. See [Section 3.3 on page 42](#).
- 2 Check the hardware connections. See [Section 3.1 on page 36](#).
- 3 Inspect your cables for damage. Contact the vendor to replace any damaged cables.
- 4 Turn the Switch off and on.
- 5 Disconnect and re-connect the power adapter or cord to the Switch.
- 6 If the problem continues, contact the vendor.

53.2 Switch Access and Login

I forgot the IP address for the Switch.

- 1 The default IP address is **http://DHCP-assigned IP** (when connecting to a DHCP server) or **192.168.1.1**.
- 2 Use the NCC (Nebula Control Center) or the ZON utility to find the IP address. The Switch must be registered and added to a site in Nebula in order for it to be managed using Nebula.
- 3 If the Switch is removed from a site in Nebula, all the settings in the configuration file are reset to the Nebula factory defaults except for the IP address. If you changed the default dynamic IP address to a static IP address while the Switch was in a site in Nebula, the Switch will retain that static IP address after you remove it from the site in Nebula.
- 4 If this does not work, you have to reset the device to its factory defaults. See [Section 4.7 on page 59](#).

I forgot the user name and/or password.

- 1 The default user name is **admin** and the default password is **1234**.
- 2 If this does not work, you have to reset the device to its factory defaults. See [Section 4.7 on page 59](#).

I cannot see or access the **Login** screen in the Web Configurator.

- 1 Make sure you are using the correct IP address.
 - The default IP address is [http://DHCP-assigned IP](#) (when connecting to a DHCP server) or [192.168.1.1](#).
 - If you changed the IP address, use the new IP address.
 - If you changed the IP address and have forgotten it, see the troubleshooting suggestions for [I forgot the IP address for the Switch](#).
- 2 Check the hardware connections, and make sure the LEDs are behaving as expected. See [Section 3.3 on page 42](#).
- 3 Make sure your Internet browser does not block pop-up windows and has JavaScripts and Java enabled.
- 4 Make sure your computer is in the same subnet as the Switch. (If you know that there are routers between your computer and the Switch, skip this step.)
- 5 Reset the device to its factory defaults, and try to access the Switch with the default IP address. See [Section 4.7 on page 59](#).

- 6 If the problem continues, contact the vendor, or try the advanced suggestion.

Advanced Suggestion

- Try to access the Switch using another service, such as Telnet. If you can access the Switch, check the remote management settings to find out why the Switch does not respond to HTTP.

I can see the **Login** screen, but I cannot log in to the Switch.

- 1 Make sure you have entered the user name and password correctly. The default user name is **admin**, and the default password is **1234**. These fields are case-sensitive, so make sure [Caps Lock] is not on.
- 2 You may have exceeded the maximum number of concurrent Telnet sessions. Close other Telnet sessions or try connecting again later.

Check that you have enabled logins for HTTP or Telnet. If you have configured a secured client IP address, your computer's IP address must match it. Refer to the chapter on access control for details.
- 3 Disconnect and re-connect the cord to the Switch.
- 4 If this does not work, you have to reset the device to its factory defaults. See [Section 4.7 on page 59](#).

Pop-up Windows, JavaScripts and Java Permissions

In order to use the Web Configurator you need to allow:

- Web browser pop-up windows from your device.
- JavaScripts (enabled by default).
- Java permissions (enabled by default).

There is unauthorized access to my Switch via telnet, HTTP and SSH.

Click the **Display** button in the **System Log** field in the **Management > Diagnostic** screen to check for unauthorized access to your Switch. To avoid unauthorized access, configure the secured client setting in the **Management > Access Control > Remote Management** screen for telnet, HTTP and SSH (see [Section 42.6 on page 365](#)). Computers not belonging to the secured client set cannot get permission to access the Switch.

53.3 Switch Configuration

I lost my configuration settings after I restart the Switch.

Make sure you save your configuration into the Switch's non-volatile memory each time you make changes. Click **Save** at the top right corner of the Web Configurator to save the configuration permanently. See also [Section 41.2.2 on page 346](#) for more information about how to save your configuration.



I accidentally unplugged the Switch. I am not sure which configuration file will be loaded.

If you plug the power cable back to the Switch, it will reboot and load the configuration file that was used the last time. For example, if **Config 1** was used on the Switch before you accidentally unplugged the Switch, **Config 1** will be loaded when rebooting.

APPENDIX A

Customer Support

In the event of problems that cannot be solved by using this manual, you should contact your vendor. If you cannot contact your vendor, then contact a Zyxel office for the region in which you bought the device.

See <https://www.zyxel.com/homepage.shtml> and also https://www.zyxel.com/about_zyxel/zyxel_worldwide.shtml for the latest information.

Please have the following information ready when you contact an office.

Required Information

- Product model and serial number.
- Warranty Information.
- Date that you received your device.
- Brief description of the problem and the steps you took to solve it.

Corporate Headquarters (Worldwide)

Taiwan

- Zyxel Communications Corporation
- <http://www.zyxel.com>

Asia

China

- Zyxel Communications (Shanghai) Corp.
- Zyxel Communications (Beijing) Corp.
- Zyxel Communications (Tianjin) Corp.
- <https://www.zyxel.com/cn/zh/>

India

- Zyxel Technology India Pvt Ltd.
- <https://www.zyxel.com/in/en/>

Kazakhstan

- Zyxel Kazakhstan
- <https://www.zyxel.kz>

Korea

- Zyxel Korea Corp.
- <http://www.zyxel.kr>

Malaysia

- Zyxel Malaysia Sdn Bhd.
- <http://www.zyxel.com.my>

Pakistan

- Zyxel Pakistan (Pvt.) Ltd.
- <http://www.zyxel.com.pk>

Philippines

- Zyxel Philippines
- <http://www.zyxel.com.ph>

Singapore

- Zyxel Singapore Pte Ltd.
- <http://www.zyxel.com.sg>

Taiwan

- Zyxel Communications Corporation
- <https://www.zyxel.com/tw/zh/>

Thailand

- Zyxel Thailand Co., Ltd.
- <https://www.zyxel.com/th/th/>

Vietnam

- Zyxel Communications Corporation-Vietnam Office
- <https://www.zyxel.com/vn/vi>

Europe

Belarus

- Zyxel BY
- <https://www.zyxel.by>

Belgium

- Zyxel Communications B.V.
- <https://www.zyxel.com/be/nl/>

- <https://www.zyxel.com/be/fr/>

Bulgaria

- Zyxel България
- <https://www.zyxel.com/bg/bg/>

Czech Republic

- Zyxel Communications Czech s.r.o
- <https://www.zyxel.com/cz/cs/>

Denmark

- Zyxel Communications A/S
- <https://www.zyxel.com/dk/da/>

Estonia

- Zyxel Estonia
- <https://www.zyxel.com/ee/et/>

Finland

- Zyxel Communications
- <https://www.zyxel.com/fi/fi/>

France

- Zyxel France
- <https://www.zyxel.fr>

Germany

- Zyxel Deutschland GmbH
- <https://www.zyxel.com/de/de/>

Hungary

- Zyxel Hungary & SEE
- <https://www.zyxel.com/hu/hu/>

Italy

- Zyxel Communications Italy
- <https://www.zyxel.com/it/it/>

Latvia

- Zyxel Latvia
- <https://www.zyxel.com/lv/lv/>

Lithuania

- Zyxel Lithuania
- <https://www.zyxel.com/lt/lt/>

Netherlands

- Zyxel Benelux
- <https://www.zyxel.com/nl/nl/>

Norway

- Zyxel Communications
- <https://www.zyxel.com/no/no/>

Poland

- Zyxel Communications Poland
- <https://www.zyxel.com/pl/pl/>

Romania

- Zyxel Romania
- <https://www.zyxel.com/ro/ro/>

Russia

- Zyxel Russia
- <https://www.zyxel.com/ru/ru/>

Slovakia

- Zyxel Communications Czech s.r.o. organizacna zlozka
- <https://www.zyxel.com/sk/sk/>

Spain

- Zyxel Communications ES Ltd.
- <https://www.zyxel.com/es/es/>

Sweden

- Zyxel Communications
- <https://www.zyxel.com/se/sv/>

Switzerland

- Studerus AG
- <https://www.zyxel.ch/de>
- <https://www.zyxel.ch/fr>

Turkey

- Zyxel Turkey A.S.
- <https://www.zyxel.com/tr/tr/>

UK

- Zyxel Communications UK Ltd.
- <https://www.zyxel.com/uk/en/>

Ukraine

- Zyxel Ukraine
- <http://www.ua.zyxel.com>

South America

Argentina

- Zyxel Communications Corporation
- <https://www.zyxel.com/co/es/>

Brazil

- Zyxel Communications Brasil Ltda.
- <https://www.zyxel.com/br/pt/>

Colombia

- Zyxel Communications Corporation
- <https://www.zyxel.com/co/es/>

Ecuador

- Zyxel Communications Corporation
- <https://www.zyxel.com/co/es/>

South America

- Zyxel Communications Corporation
- <https://www.zyxel.com/co/es/>

Middle East

Israel

- Zyxel Communications Corporation
- <http://il.zyxel.com/>

Middle East

- Zyxel Communications Corporation
- <https://www.zyxel.com/me/en/>

North America

USA

- Zyxel Communications, Inc. – North America Headquarters
- <https://www.zyxel.com/us/en/>

Oceania

Australia

- Zyxel Communications Corporation
- <https://www.zyxel.com/au/en/>

Africa

South Africa

- Nology (Pty) Ltd.
- <https://www.zyxel.com/za/en/>

APPENDIX B

Common Services

The following table lists some commonly-used services and their associated protocols and port numbers. For a comprehensive list of port numbers, ICMP type or code numbers and services, visit the IANA (Internet Assigned Number Authority) web site.

- **Name:** This is a short, descriptive name for the service. You can use this one or create a different one, if you like.
- **Protocol:** This is the type of IP protocol used by the service. If this is **TCP/UDP**, then the service uses the same port number with TCP and UDP. If this is **User-Defined**, the **Port(s)** is the IP protocol number, not the port number.
- **Port(s):** This value depends on the **Protocol**. Please refer to RFC 1700 for further information about port numbers.
 - If the **Protocol** is **TCP, UDP, or TCP/UDP**, this is the IP port number.
 - If the **Protocol** is **USER**, this is the IP protocol number.
- **Description:** This is a brief explanation of the applications that use this service or the situations in which this service is used.

Table 208 Commonly Used Services

NAME	PROTOCOL	PORT(S)	DESCRIPTION
AH (IPSEC_TUNNEL)	User-Defined	51	The IPSEC AH (Authentication Header) tunneling protocol uses this service.
AIM/New-ICQ	TCP	5190	AOL's Internet Messenger service. It is also used as a listening port by ICQ.
AUTH	TCP	113	Authentication protocol used by some servers.
BGP	TCP	179	Border Gateway Protocol.
BOOTP_CLIENT	UDP	68	DHCP Client.
BOOTP_SERVER	UDP	67	DHCP Server.
CU-SEEME	TCP UDP	7648 24032	A popular videoconferencing solution from White Pines Software.
DNS	TCP/UDP	53	Domain Name Server, a service that matches web names (for example www.zyxel.com) to IP numbers.
ESP (IPSEC_TUNNEL)	User-Defined	50	The IPSEC ESP (Encapsulation Security Protocol) tunneling protocol uses this service.
FINGER	TCP	79	Finger is a UNIX or Internet related command that can be used to find out if a user is logged on.
FTP	TCP TCP	20 21	File Transfer Program, a program to enable fast transfer of files, including large files that may not be possible by email.
H.323	TCP	1720	NetMeeting uses this protocol.
HTTP	TCP	80	Hyper Text Transfer Protocol – a client or server protocol for the world wide web.

Table 208 Commonly Used Services (continued)

NAME	PROTOCOL	PORT(S)	DESCRIPTION
HTTPS	TCP	443	HTTPS is a secured http session often used in e-commerce.
ICMP	User-Defined	1	Internet Control Message Protocol is often used for diagnostic or routing purposes.
ICQ	UDP	4000	This is a popular Internet chat program.
IGMP (MULTICAST)	User-Defined	2	Internet Group Multicast Protocol is used when sending packets to a specific group of hosts.
IKE	UDP	500	The Internet Key Exchange algorithm is used for key distribution and management.
IRC	TCP/UDP	6667	This is another popular Internet chat program.
MSN Messenger	TCP	1863	Microsoft Networks' messenger service uses this protocol.
NEW-ICQ	TCP	5190	An Internet chat program.
NEWS	TCP	144	A protocol for news groups.
NFS	UDP	2049	Network File System – NFS is a client or server distributed file service that provides transparent file sharing for network environments.
NNTP	TCP	119	Network News Transport Protocol is the delivery mechanism for the USENET newsgroup service.
PING	User-Defined	1	Packet Internet Groper is a protocol that sends out ICMP echo requests to test whether or not a remote host is reachable.
POP3	TCP	110	Post Office Protocol version 3 lets a client computer get e-mail from a POP3 server through a temporary connection (TCP/IP or other).
PPTP	TCP	1723	Point-to-Point Tunneling Protocol enables secure transfer of data over public networks. This is the control channel.
PPTP_TUNNEL (GRE)	User-Defined	47	PPTP (Point-to-Point Tunneling Protocol) enables secure transfer of data over public networks. This is the data channel.
RCMD	TCP	512	Remote Command Service.
REAL_AUDIO	TCP	7070	A streaming audio service that enables real time sound over the web.
REXEC	TCP	514	Remote Execution Daemon.
RLOGIN	TCP	513	Remote Login.
RTELNET	TCP	107	Remote Telnet.
RTSP	TCP/UDP	554	The Real Time Streaming (media control) Protocol (RTSP) is a remote control for multimedia on the Internet.
SFTP	TCP	115	Simple File Transfer Protocol.
SMTP	TCP	25	Simple Mail Transfer Protocol is the message-exchange standard for the Internet. SMTP enables you to move messages from one email server to another.
SNMP	TCP/UDP	161	Simple Network Management Program.
SNMP-TRAPS	TCP/UDP	162	Traps for use with the SNMP (RFC:1215).

Table 208 Commonly Used Services (continued)

NAME	PROTOCOL	PORT(S)	DESCRIPTION
SQL-NET	TCP	1521	Structured Query Language is an interface to access data on many different types of database systems, including mainframes, midrange systems, UNIX systems and network servers.
SSH	TCP/UDP	22	Secure Shell Remote Login Program.
STRM WORKS	UDP	1558	Stream Works Protocol.
SYSLOG	UDP	514	Syslog allows you to send system logs to a UNIX server.
TACACS	UDP	49	Login Host Protocol used for (Terminal Access Controller Access Control System).
TELNET	TCP	23	Telnet is the login and terminal emulation protocol common on the Internet and in UNIX environments. It operates over TCP/IP networks. Its primary function is to allow users to log into remote host systems.
TFTP	UDP	69	Trivial File Transfer Protocol is an Internet file transfer protocol similar to FTP, but uses the UDP (User Datagram Protocol) rather than TCP (Transmission Control Protocol).
VDOLIVE	TCP	7000	Another videoconferencing solution.

APPENDIX C

IPv6

Overview

IPv6 (Internet Protocol version 6), is designed to enhance IP address size and features. The increase in IPv6 address size to 128 bits (from the 32-bit IPv4 address) allows up to 3.4×10^{38} IP addresses.

IPv6 Addressing

The 128-bit IPv6 address is written as eight 16-bit hexadecimal blocks separated by colons (:). This is an example IPv6 address `2001:0db8:1a2b:0015:0000:0000:1a2f:0000`.

IPv6 addresses can be abbreviated in two ways:

- Leading zeros in a block can be omitted. So `2001:0db8:1a2b:0015:0000:0000:1a2f:0000` can be written as `2001:db8:1a2b:15:0:0:1a2f:0`.
- Any number of consecutive blocks of zeros can be replaced by a double colon. A double colon can only appear once in an IPv6 address. So `2001:0db8:0000:0000:1a2f:0000:0000:0015` can be written as `2001:0db8::1a2f:0000:0000:0015`, `2001:0db8:0000:0000:1a2f::0015`, `2001:db8::1a2f:0:0:15` or `2001:db8:0:0:1a2f::15`.

Prefix and Prefix Length

Similar to an IPv4 subnet mask, IPv6 uses an address prefix to represent the network address. An IPv6 prefix length specifies how many most significant bits (start from the left) in the address compose the network address. The prefix length is written as “/x” where x is a number. For example,

`2001:db8:1a2b:15::1a2f:0/32`

means that the first 32 bits (`2001:db8`) is the subnet prefix.

Link-local Address

A link-local address uniquely identifies a device on the local network (the LAN). It is similar to a “private IP address” in IPv4. You can have the same link-local address on multiple interfaces on a device. A link-local unicast address has a predefined prefix of `fe80::/10`. The link-local unicast address format is as follows.

Table 209 Link-local Unicast Address Format

1111 1110 10	0	Interface ID
10 bits	54 bits	64 bits

Global Address

A global address uniquely identifies a device on the Internet. It is similar to a “public IP address” in IPv4. A global unicast address starts with a 2 or 3.

Unspecified Address

An unspecified address (0:0:0:0:0:0 or ::) is used as the source address when a device does not have its own address. It is similar to "0.0.0.0" in IPv4.

Loopback Address

A loopback address (0:0:0:0:0:1 or ::1) allows a host to send packets to itself. It is similar to "127.0.0.1" in IPv4.

Multicast Address

In IPv6, multicast addresses provide the same functionality as IPv4 broadcast addresses. Broadcasting is not supported in IPv6. A multicast address allows a host to send packets to all hosts in a multicast group.

Multicast scope allows you to determine the size of the multicast group. A multicast address has a predefined prefix of ff00::/8. The following table describes some of the predefined multicast addresses.

Table 210 Predefined Multicast Address

MULTICAST ADDRESS	DESCRIPTION
FF01:0:0:0:0:0:1	All hosts on a local node.
FF01:0:0:0:0:0:2	All routers on a local node.
FF02:0:0:0:0:0:1	All hosts on a local connected link.
FF02:0:0:0:0:0:2	All routers on a local connected link.
FF05:0:0:0:0:0:2	All routers on a local site.
FF05:0:0:0:0:0:1:3	All DHCP servers on a local site.

The following table describes the multicast addresses which are reserved and cannot be assigned to a multicast group.

Table 211 Reserved Multicast Address

MULTICAST ADDRESS
FF00:0:0:0:0:0:0:0
FF01:0:0:0:0:0:0:0
FF02:0:0:0:0:0:0:0
FF03:0:0:0:0:0:0:0
FF04:0:0:0:0:0:0:0
FF05:0:0:0:0:0:0:0
FF06:0:0:0:0:0:0:0
FF07:0:0:0:0:0:0:0
FF08:0:0:0:0:0:0:0
FF09:0:0:0:0:0:0:0
FF0A:0:0:0:0:0:0:0
FF0B:0:0:0:0:0:0:0
FF0C:0:0:0:0:0:0:0
FF0D:0:0:0:0:0:0:0
FF0E:0:0:0:0:0:0:0
FF0F:0:0:0:0:0:0:0

Subnet Masking

Both an IPv6 address and IPv6 subnet mask compose of 128-bit binary digits, which are divided into eight 16-bit blocks and written in hexadecimal notation. Hexadecimal uses 4 bits for each character (1 – 10, A – F). Each block's 16 bits are then represented by 4 hexadecimal characters. For example, FFFF:FFFF:FFFF:FFFF:FC00:0000:0000:0000.

Interface ID

In IPv6, an interface ID is a 64-bit identifier. It identifies a physical interface (for example, an Ethernet port) or a virtual interface (for example, the management IP address for a VLAN). One interface should have a unique interface ID.

EUI-64

The EUI-64 (Extended Unique Identifier) defined by the IEEE (Institute of Electrical and Electronics Engineers) is an interface ID format designed to adapt with IPv6. It is derived from the 48-bit (6-byte) Ethernet MAC address as shown next. EUI-64 inserts the hex digits fffe between the third and fourth bytes of the MAC address and complements the seventh bit of the first byte of the MAC address. See the following example.

Table 212

MAC	00	:	13	:	49	:	12	:	34	:	56
-----	----	---	----	---	----	---	----	---	----	---	----

Table 213

EUI-64	02	:	13	:	49	:	FF	:	FE	:	12	:	34	:	56
--------	----	---	----	---	----	---	----	---	----	---	----	---	----	---	----

DHCPv6

The Dynamic Host Configuration Protocol for IPv6 (DHCPv6, RFC 3315) is a server-client protocol that allows a DHCP server to assign and pass IPv6 network addresses, prefixes and other configuration information to DHCP clients. DHCPv6 servers and clients exchange DHCP messages using UDP.

Each DHCP client and server has a unique DHCP Unique Identifier (DUID), which is used for identification when they are exchanging DHCPv6 messages. The DUID is generated from the MAC address, time, vendor assigned ID and/or the vendor's private enterprise number registered with the IANA. It should not change over time even after you reboot the device.

Identity Association

An Identity Association (IA) is a collection of addresses assigned to a DHCP client, through which the server and client can manage a set of related IP addresses. Each IA must be associated with exactly one interface. The DHCP client uses the IA assigned to an interface to obtain configuration from a DHCP server for that interface. Each IA consists of a unique IAID and associated IP information.

The IA type is the type of address in the IA. Each IA holds one type of address. IA_NA means an identity association for non-temporary addresses and IA_TA is an identity association for temporary addresses.

An IA_NA option contains the T1 and T2 fields, but an IA_TA option does not. The DHCPv6 server uses T1 and T2 to control the time at which the client contacts with the server to extend the lifetimes on any addresses in the IA_NA before the lifetimes expire. After T1, the client sends the server (S1) (from which the addresses in the IA_NA were obtained) a Renew message. If the time T2 is reached and the server does not respond, the client sends a Rebind message to any available server (S2). For an IA_TA, the

client may send a Renew or Rebind message at the client's discretion.

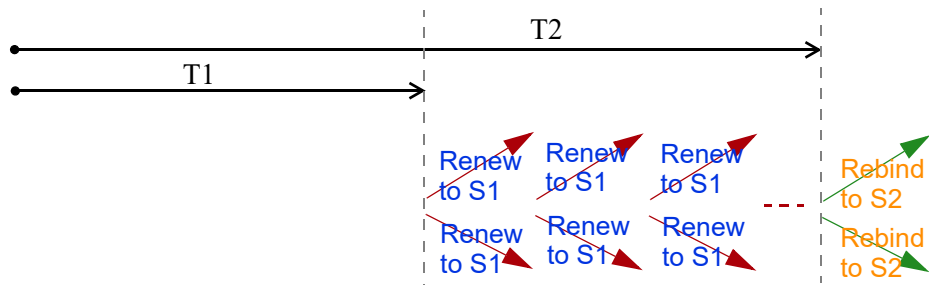

DHCP Relay Agent

A DHCP relay agent is on the same network as the DHCP clients and helps forward messages between the DHCP server and clients. When a client cannot use its link-local address and a well-known multicast address to locate a DHCP server on its network, it then needs a DHCP relay agent to send a message to a DHCP server that is not attached to the same network.

The DHCP relay agent can add the remote identification (remote-ID) option and the interface-ID option to the Relay-Forward DHCPv6 messages. The remote-ID option carries a user-defined string, such as the system name. The interface-ID option provides slot number, port information and the VLAN ID to the DHCPv6 server. The remote-ID option (if any) is stripped from the Relay-Reply messages before the relay agent sends the packets to the clients. The DHCP server copies the interface-ID option from the Relay-Forward message into the Relay-Reply message and sends it to the relay agent. The interface-ID should not change even after the relay agent restarts.

Prefix Delegation

Prefix delegation enables an IPv6 router to use the IPv6 prefix (network address) received from the ISP (or a connected uplink router) for its LAN. The Switch uses the received IPv6 prefix (for example, 2001:db2::/48) to generate its LAN IP address. Through sending Router Advertisements (RAs) regularly by multicast, the Switch passes the IPv6 prefix information to its LAN hosts. The hosts then can use the prefix to generate their IPv6 addresses.

ICMPv6

Internet Control Message Protocol for IPv6 (ICMPv6 or ICMP for IPv6) is defined in RFC 4443. ICMPv6 has a preceding Next Header value of 58, which is different from the value used to identify ICMP for IPv4. ICMPv6 is an integral part of IPv6. IPv6 nodes use ICMPv6 to report errors encountered in packet processing and perform other diagnostic functions, such as "ping".

Neighbor Discovery Protocol (NDP)

The Neighbor Discovery Protocol (NDP) is a protocol used to discover other IPv6 devices and track neighbor's reachability in a network. An IPv6 device uses the following ICMPv6 messages types:

- Neighbor solicitation: A request from a host to determine a neighbor's link-layer address (MAC address) and detect if the neighbor is still reachable. A neighbor being "reachable" means it responds to a neighbor solicitation message (from the host) with a neighbor advertisement message.
- Neighbor advertisement: A response from a node to announce its link-layer address.
- Router solicitation: A request from a host to locate a router that can act as the default router and

forward packets.

- Router advertisement: A response to a router solicitation or a periodical multicast advertisement from a router to advertise its presence and other parameters.

IPv6 Cache

An IPv6 host is required to have a neighbor cache, destination cache, prefix list and default router list. The Switch maintains and updates its IPv6 caches constantly using the information from response messages. In IPv6, the Switch configures a link-local address automatically, and then sends a neighbor solicitation message to check if the address is unique. If there is an address to be resolved or verified, the Switch also sends out a neighbor solicitation message. When the Switch receives a neighbor advertisement in response, it stores the neighbor's link-layer address in the neighbor cache. When the Switch uses a router solicitation message to query for a router and receives a router advertisement message, it adds the router's information to the neighbor cache, prefix list and destination cache. The Switch creates an entry in the default router list cache if the router can be used as a default router.

When the Switch needs to send a packet, it first consults the destination cache to determine the next hop. If there is no matching entry in the destination cache, the Switch uses the prefix list to determine whether the destination address is on-link and can be reached directly without passing through a router. If the address is onlink, the address is considered as the next hop. Otherwise, the Switch determines the next-hop from the default router list or routing table. Once the next hop IP address is known, the Switch looks into the neighbor cache to get the link-layer address and sends the packet when the neighbor is reachable. If the Switch cannot find an entry in the neighbor cache or the state for the neighbor is not reachable, it starts the address resolution process. This helps reduce the number of IPv6 solicitation and advertisement messages.

Multicast Listener Discovery

The Multicast Listener Discovery (MLD) protocol (defined in RFC 2710) is derived from IPv4's Internet Group Management Protocol version 2 (IGMPv2). MLD uses ICMPv6 message types, rather than IGMP message types. MLDv1 is equivalent to IGMPv2 and MLDv2 is equivalent to IGMPv3.

MLD allows an IPv6 switch or router to discover the presence of MLD listeners who wish to receive multicast packets and the IP addresses of multicast groups the hosts want to join on its network.

MLD snooping and MLD proxy are analogous to IGMP snooping and IGMP proxy in IPv4.

MLD filtering controls which multicast groups a port can join.

MLD Messages

A multicast router or switch periodically sends general queries to MLD hosts to update the multicast forwarding table. When an MLD host wants to join a multicast group, it sends an MLD Report message for that address.

An MLD Done message is equivalent to an IGMP Leave message. When an MLD host wants to leave a multicast group, it can send a Done message to the router or switch. The router or switch then sends a group-specific query to the port on which the Done message is received to determine if other devices connected to this port should remain in the group.

Example – Enabling IPv6 on Windows XP/2003/Vista

By default, Windows XP and Windows 2003 support IPv6. This example shows you how to use the `ipv6 install` command on Windows XP or 2003 to enable IPv6. This also displays how to use the `ipconfig` command to see auto-generated IP addresses.

```
C:\>ipv6 install
Installing...
Succeeded.

C:\>ipconfig

Windows IP Configuration

Ethernet adapter Local Area Connection:

    Connection-specific DNS Suffix  . :
    IP Address. . . . . : 10.1.1.46
    Subnet Mask . . . . . : 255.255.255.0
    IP Address. . . . . : fe80::2d0:59ff:feb8:103c%4
    Default Gateway . . . . . : 10.1.1.254
```

IPv6 is installed and enabled by default in Windows Vista. Use the `ipconfig` command to check your automatic configured IPv6 address as well. You should see at least one IPv6 address available for the interface on your computer.

Example – Enabling DHCPv6 on Windows XP

Windows XP does not support DHCPv6. If your network uses DHCPv6 for IP address assignment, you have to additionally install a DHCPv6 client software on your Windows XP. (Note: If you use static IP addresses or Router Advertisement for IPv6 address assignment in your network, ignore this section.)

This example uses Dibbler as the DHCPv6 client. To enable DHCPv6 client on your computer:

- 1 Install Dibbler and select the DHCPv6 client option on your computer.
- 2 After the installation is complete, select **Start > All Programs > Dibbler-DHCPv6 > Client Install as service**.
- 3 Select **Start > Control Panel > Administrative Tools > Services**.
- 4 Double click **Dibbler – a DHCPv6 client**.

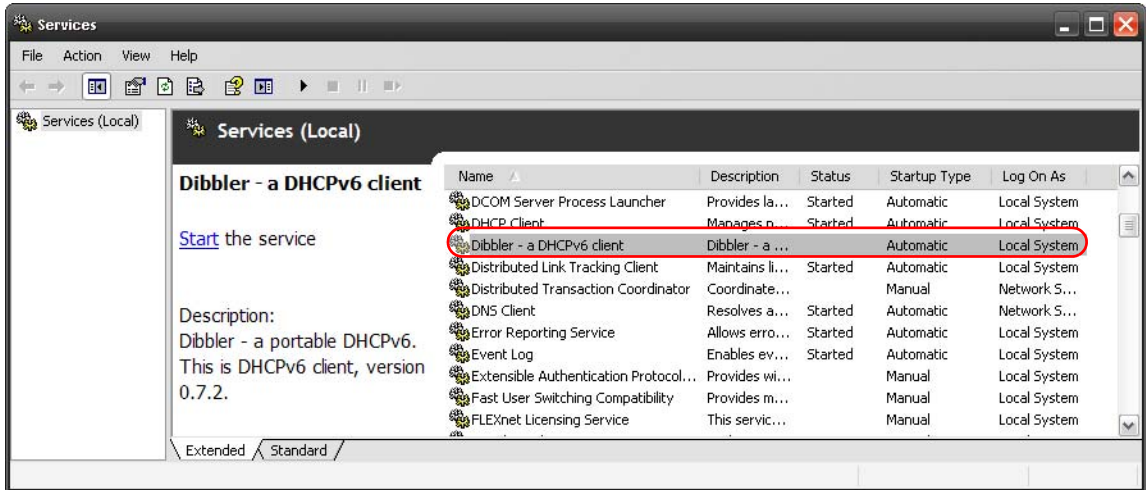

- 5 Click **Start** and then **OK**.

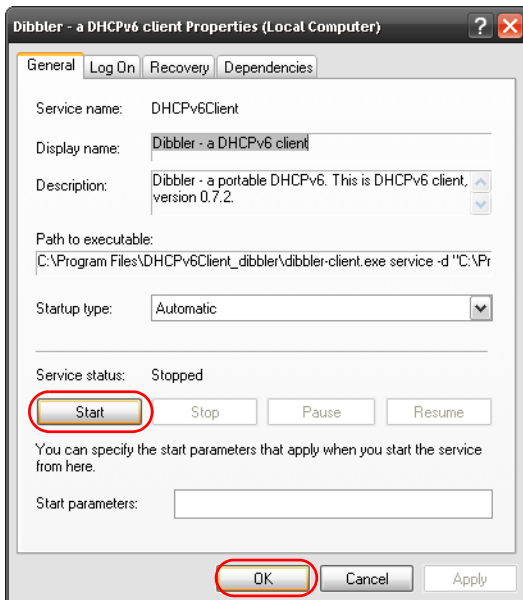

- 6 Now your computer can obtain an IPv6 address from a DHCPv6 server.

Example – Enabling IPv6 on Windows 7

Windows 7 supports IPv6 by default. DHCPv6 is also enabled when you enable IPv6 on a Windows 7 computer.

To enable IPv6 in Windows 7:

- 1 Select **Control Panel > Network and Sharing Center > Local Area Connection**.
- 2 Select the **Internet Protocol Version 6 (TCP/IPv6)** check box to enable it.
- 3 Click **OK** to save the change.

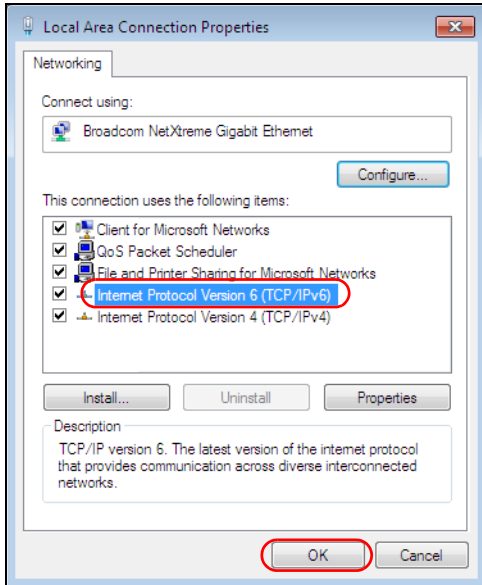

- 4 Click **Close** to exit the **Local Area Connection Status** screen.
- 5 Select **Start > All Programs > Accessories > Command Prompt**.
- 6 Use the `ipconfig` command to check your dynamic IPv6 address. This example shows a global address (2001:b021:2d::1000) obtained from a DHCP server.

```
C:\>ipconfig

Windows IP Configuration

Ethernet adapter Local Area Connection:

    Connection-specific DNS Suffix  . :
    IPv6 Address. . . . . : 2001:b021:2d::1000
    Link-local IPv6 Address . . . . . : fe80::25d8:dcab:c80a:5189%11
    IPv4 Address. . . . . : 172.16.100.61
    Subnet Mask . . . . . : 255.255.255.0
    Default Gateway . . . . . : fe80::213:49ff:feaa:7125%11
                                172.16.100.254
```

APPENDIX D

Legal Information

Copyright

Copyright © 2020 by Zyxel Communications Corporation.

The contents of this publication may not be reproduced in any part or as a whole, transcribed, stored in a retrieval system, translated into any language, or transmitted in any form or by any means, electronic, mechanical, magnetic, optical, chemical, photocopying, manual, or otherwise, without the prior written permission of Zyxel Communications Corporation.

Published by Zyxel Communications Corporation. All rights reserved.

Disclaimer

Zyxel does not assume any liability arising out of the application or use of any products, or software described herein. Neither does it convey any license under its patent rights nor the patent rights of others. Zyxel further reserves the right to make changes in any products described herein without notice. This publication is subject to change without notice.

Regulatory Notice and Statement

United States of America



The following information applies if you use the product within USA area.

US Importer: Zyxel Communications, Inc, 1130 North Miller Street Anaheim, CA92806-2001, <https://www.zyxel.com/us/en/>

Federal Communications Commission (FCC) EMC Statement

- This device complies with Part 15 of FCC rules. Operation is subject to the following two conditions:
 - (1) This device may not cause harmful interference.
 - (2) This device must accept any interference received, including interference that may cause undesired operations.
- Changes or modifications not expressly approved by the party responsible for compliance could void the user's authority to operate the equipment.
- This equipment has been tested and found to comply with the limits for a Class A digital device, pursuant to part 15 of the FCC Rules. These limits are designed to provide reasonable protection against harmful interference when the equipment is operated in a commercial environment. This equipment generates, uses, and can radiate radio frequency energy and, if not installed and used in accordance with the instruction manual, may cause harmful interference to radio communications. Operation of this equipment in a residential area is likely to cause harmful interference in which case the user will be required to correct the interference at his own expense.

Canada

The following information applies if you use the product within Canada area.

Innovation, Science and Economic Development Canada ICES statement

CAN ICES-3 (A)/NMB-3(A)

European Union



The following information applies if you use the product within the European Union.

CE EMC statement

WARNING: This equipment is compliant with Class A of EN55032. In a residential environment this equipment may cause radio interference.

List of National Codes

COUNTRY	ISO 3166 2 LETTER CODE	COUNTRY	ISO 3166 2 LETTER CODE
Austria	AT	Liechtenstein	LI
Belgium	BE	Lithuania	LT
Bulgaria	BG	Luxembourg	LU
Croatia	HR	Malta	MT
Cyprus	CY	Netherlands	NL
Czech Republic	CR	Norway	NO
Denmark	DK	Poland	PL
Estonia	EE	Portugal	PT
Finland	FI	Romania	RO
France	FR	Serbia	RS
Germany	DE	Slovakia	SK
Greece	GR	Slovenia	SI
Hungary	HU	Spain	ES
Iceland	IS	Sweden	SE
Ireland	IE	Switzerland	CH
Italy	IT	Turkey	TR
Latvia	LV	United Kingdom	GB

Safety Warnings

- To avoid possible eye injury, do NOT look into an operating fiber-optic module's connector.
- Do NOT use this product near water, for example, in a wet basement or near a swimming pool.
- Do NOT expose your device to dampness, dust or corrosive liquids.
- Do NOT store things on the device.
- Do NOT obstruct the device ventilation slots as insufficient airflow may harm your device. For example, do not place the device in an enclosed space such as a box or on a very soft surface such as a bed or sofa.
- Do NOT install, use, or service this device during a thunderstorm. There is a remote risk of electric shock from lightning.
- Connect ONLY suitable accessories to the device.
- Do NOT open the device or unit. Opening or removing covers can expose you to dangerous high voltage points or other risks. Only qualified service personnel should service or disassemble this device. Please contact your vendor for further information.
- Make sure to connect the cables to the correct ports.
- Place connecting cables carefully so that no one will step on them or stumble over them.
- Always disconnect all cables from this device before servicing or disassembling.
- Do NOT remove the plug and connect it to a power outlet by itself; always attach the plug to the power adaptor first before connecting it to a power outlet.
- Do NOT allow anything to rest on the power adaptor or cord and do NOT place the product where anyone can walk on the power adaptor or cord.
- Please use the provided or designated connection cables/power cables/adaptors. Connect it to the right supply voltage (for example, 110V AC in North America or 230V AC in Europe). If the power adaptor or cord is damaged, it might cause electrocution. Remove it from the device and the power source, repairing the power adapter or cord is prohibited. Contact your local vendor to order a new one.
- Do NOT use the device outside, and make sure all the connections are indoors. There is a remote risk of electric shock from lightning.
- CAUTION: RISK OF EXPLOSION IF BATTERY IS REPLACED BY AN INCORRECT TYPE, DISPOSE OF USED BATTERIES ACCORDING TO THE INSTRUCTION. Dispose them at the applicable collection point for the recycling of electrical and electronic device. For detailed information about recycling of this product, please contact your local city office, your household waste disposal service or the store where you purchased the product.
- Use ONLY power wires of the appropriate wire gauge for your device. Connect it to a power supply of the correct voltage.
- Fuse Warning! Replace a fuse only with a fuse of the same type and rating.
- The POE (Power over Ethernet) devices that supply or receive power and their connected Ethernet cables must all be completely indoors.
- The following warning statements apply, where the disconnect device is not incorporated in the device or where the plug on the power supply cord is intended to serve as the disconnect device.
 - For PERMANENTLY CONNECTED DEVICES, a readily accessible disconnect device shall be incorporated external to the device;
 - For PLUGGABLE DEVICES, the socket-outlet shall be installed near the device and shall be easily accessible.
- This device must be grounded by qualified service personnel. Never defeat the ground conductor or operate the device in the absence of a suitably installed ground conductor. Contact the appropriate electrical inspection authority or an electrician if you are uncertain that suitable grounding is available.
- If your device has an earthing screw (frame ground), connect the screw to a ground terminal using an appropriate AWG ground wire. Do this before you make other connections.
- If your device has no earthing screw, but has a 3-prong power plug, make sure to connect the plug to a 3-hole earthed socket.
- When connecting or disconnecting power to hot-pluggable power supplies, if offered with your system, observe the following guidelines:
 - Install the power supply before connecting the power cable to the power supply.
 - Unplug the power cable before removing the power supply.
 - If the system has multiple sources of power, disconnect power from the system by unplugging all power cables from the power supply.
- CLASS 1 LASER PRODUCT (for products with mini-GBIC slots or laser products, such as fiber-optic transceiver and GPON products).

- PRODUCT COMPLIES WITH 21 CFR 1040.10 AND 1040.11. (for products with mini-GBIC slots or laser products, such as fiber-optic transceiver and GPON products)
- APPAREIL À LASER DE CLASS 1 (for products with mini-GBIC slots or laser products, such as fiber-optic transceiver and GPON products).
- PRODUIT CONFORME SELON 21 CFR 1040.10 ET 1040.11. (for products with mini-GBIC slots or laser products, such as fiber-optic transceiver and GPON products)

Important Safety Instructions

1 Warning! Energy Hazard. Remove all metal jewelry, watches, and so on from your hands and wrists before serving this device.

2 Caution! The RJ-45 jacks are not used for telephone line connection.

3  Hazardous Moving Parts. Keep body parts away from fan blades.

4  Hot Surface. Do not touch.

1 Avertissement: Risque de choc électrique. Retirer tout bijoux en métal et votre montre de vos mains et poignets avant de manipuler cet appareil.

2 Attention: Les câbles RJ-45 ne doivent pas être utilisés pour les connections téléphoniques.

3  Mobilité des pièces détachées. S'assurer que les pièces détachées ne sont pas en contact avec les pales du ventilateur.

4  Surface brûlante. Ne pas toucher.

Environment Statement

European Union – Disposal and Recycling Information

The symbol below means that according to local regulations your product and/or its battery shall be disposed of separately from domestic waste. If this product is end of life, take it to a recycling station designated by local authorities. At the time of disposal, the separate collection of your product and/or its battery will help save natural resources and ensure that the environment is sustainable development.

Die folgende Symbol bedeutet, dass Ihr Produkt und/oder seine Batterie gemäß den örtlichen Bestimmungen getrennt vom Hausmüll entsorgt werden muss. Wenden Sie sich an eine Recyclingstation, wenn dieses Produkt das Ende seiner Lebensdauer erreicht hat. Zum Zeitpunkt der Entsorgung wird die getrennte Sammlung von Produkt und/oder seiner Batterie dazu beitragen, natürliche Ressourcen zu sparen und die Umwelt und die menschliche Gesundheit zu schützen.

El símbolo de abajo indica que según las regulaciones locales, su producto y/o su batería deberán depositarse como basura separada de la doméstica. Cuando este producto alcance el final de su vida útil, llévalo a un punto limpio. Cuando llegue el momento de desechar el producto, la recogida por separado éste y/o su batería ayudará a salvar los recursos naturales y a proteger la salud humana y medioambiental.

Le symbole ci-dessous signifie que selon les réglementations locales votre produit et/ou sa batterie doivent être éliminés séparément des ordures ménagères. Lorsque ce produit atteint sa fin de vie, amenez-le à un centre de recyclage. Au moment de la mise au rebut, la collecte séparée de votre produit et/ou de sa batterie aidera à économiser les ressources naturelles et protéger l'environnement et la santé humaine.

Il simbolo sotto significa che secondo i regolamenti locali il vostro prodotto e/o batteria deve essere smaltito separatamente dai rifiuti domestici. Quando questo prodotto raggiunge la fine della vita di servizio portarlo a una stazione di riciclaggio. Al momento dello smaltimento, la raccolta separata del vostro prodotto e/o della sua batteria aiuta a risparmiare risorse naturali e a proteggere l'ambiente e la salute umana.

Symbolen innebär att enligt lokal lagstiftning ska produkten och/eller dess batteri kastas separat från hushållsavfallet. När den här produkten når slutet av sin livslängd ska du ta den till en återvinningsstation. Vid tiden för kasseringen bidrar du till en bättre miljö och mänsklig hälsa genom att göra dig av med den på ett återvinningsställe.



台灣



以下訊息僅適用於產品銷售至台灣地區

- 這是甲類的資訊產品，在居住的環境中使用時，可能會造成射頻干擾，在這種情況下，使用者會被要求採取某些適當的對策。」



安全警告 – 為了您的安全，請先閱讀以下警告及指示：

- 請勿將此產品接近水、火焰或放置在高溫的環境。
- 避免設備接觸
 - 任何液體 - 切勿讓設備接觸水、雨水、高濕度、污水腐蝕性的液體或其他水份。
 - 灰塵及污物 - 切勿接觸灰塵、污物、沙土、食物或其他不合適的材料。
- 雷雨天氣時，不要安裝、使用或維修此設備。有遭受電擊的風險。
- 切勿重摔或撞擊設備，並勿使用不正確的電源變壓器。
- 若接上不正確的電源變壓器會有爆炸的風險。
- 請勿隨意更換產品內的電池。
- 如果更換不正確之電池型式，會有爆炸的風險，請依製造商說明書處理使用過之電池。
- 請將廢電池丟棄在適當的電器或電子設備回收處。
- 請勿將設備解體。
- 請勿阻礙設備的散熱孔，空氣對流不足將會造成設備損害。
- 請插在正確的電壓供給插座 (如：北美 / 台灣電壓 110V AC · 歐洲是 230V AC) 。
- 假若電源變壓器或電源變壓器的纜線損壞，請從插座拔除，若您還繼續插電使用，會有觸電死亡的風險。
- 請勿試圖修理電源變壓器或電源變壓器的纜線，若有毀損，請直接聯絡您購買的店家，購買一個新的電源變壓器。
- 請勿將此設備安裝於室外，此設備僅適合放置於室內。
- 請勿隨一般垃圾丟棄。
- 請參閱產品背貼上的設備額定功率。
- 請參考產品型錄或是彩盒上的作業溫度。
- 設備必須接地，接地導線不允許被破壞或沒有適當安裝接地導線，如果不確定接地方式是否符合要求可聯繫相應的電氣檢驗機構檢驗。
- 如果您提供的系統中有提供熱插拔電源，連接或斷開電源請遵循以下指導原則：
 - 先連接電源線至設備連，再連接電源。
 - 先斷開電源再拔除連接至設備的電源線。
 - 如果系統有多個電源，需拔除所有連接至電源的電源線再關閉設備電源。
- 產品沒有斷電裝置或者採用電源線的插頭視為斷電裝置的一部分，以下警語將適用：
 - 對永久連接之設備，在設備外部須安裝可觸及之斷電裝置；
 - 對插接式之設備，插座必須接近安裝之地點而且是易於觸及的。

About the Symbols

Various symbols are used in this product to ensure correct usage, to prevent danger to the user and others, and to prevent property damage. The meaning of these symbols are described below. It is important that you read these descriptions thoroughly and fully understand the contents.

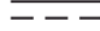
Explanation of the Symbols

SYMBOL	EXPLANATION
	Alternating current (AC): AC is an electric current in which the flow of electric charge periodically reverses direction.
	Direct current (DC): DC is the unidirectional flow or movement of electric charge carriers.
	Earth; ground: A wiring terminal intended for connection of a Protective Earthing Conductor.
	Class II equipment: The method of protection against electric shock in the case of class II equipment is either double insulation or reinforced insulation.

Viewing Certifications

Go to <http://www.zyxel.com> to view this product's documentation and certifications.

Zyxel Limited Warranty

Zyxel warrants to the original end user (purchaser) that this product is free from any defects in material or workmanship for a specific period (the Warranty Period) from the date of purchase. The Warranty Period varies by region. Check with your vendor and/or the authorized Zyxel local distributor for details about the Warranty Period of this product. During the warranty period, and upon proof of purchase, should the product have indications of failure due to faulty workmanship and/or materials, Zyxel will, at its discretion, repair or replace the defective products or components without charge for either parts or labor, and to whatever extent it shall deem necessary to restore the product or components to proper operating condition. Any replacement will consist of a new or re-manufactured functionally equivalent product of equal or higher value, and will be solely at the discretion of Zyxel. This warranty shall not apply if the product has been modified, misused, tampered with, damaged by an act of God, or subjected to abnormal working conditions.

Note

Repair or replacement, as provided under this warranty, is the exclusive remedy of the purchaser. This warranty is in lieu of all other warranties, express or implied, including any implied warranty of merchantability or fitness for a particular use or purpose. Zyxel shall in no event be held liable for indirect or consequential damages of any kind to the purchaser.

To obtain the services of this warranty, contact your vendor. You may also refer to the warranty policy for the region in which you bought the device at http://www.zyxel.com/web/support_warranty_info.php.

Registration

Register your product online at www.zyxel.com to receive email notices of firmware upgrades and related information.

Trademarks

ZyNOS (Zyxel Network Operating System) and ZON (Zyxel One Network) are registered trademarks of Zyxel Communications, Inc. Other trademarks mentioned in this publication are used for identification purposes only and may be properties of their respective owners.

Numbers

802.1P priority [94](#)

A

AAA [232](#)

- accounting [232](#)
- authentication [232](#)
- authorization [232](#)
- external server [232](#)
- RADIUS [232](#)

AAA (Authentication, Authorization and Accounting) [232](#)

access control

- limitations [357](#)
- login account [363](#)
- remote management [365](#)
- service port [364](#)
- SNMP [367](#)

Access Control screen [357](#)

accounting

- setup [237](#)

Address Resolution Protocol (ARP) [340](#), [396](#), [399](#), [400](#)

administrator password [48](#), [363](#)

age [154](#)

aging time [86](#)

air circulation

- for cooling [29](#)

All connected

- Setting Wizard [135](#)

applications

- backbone [25](#)
- bridging [25](#)
- fiber uplink [25](#)
- IEEE 802.1Q VLAN [26](#)
- PoE [24](#)
- switched workgroup [26](#)

ARP

- how it works [340](#)

learning mode [340](#)

overview [340](#)

setup [342](#)

ARP (Address Resolution Protocol) [396](#)

ARP inspection [262](#)

and MAC filter [262](#)

configuring [263](#)

syslog messages [263](#)

trusted ports [263](#)

ARP Learning screen [342](#)

ARP Setup screen [342](#)

ARP Table screen [396](#)

ARP-Reply [340](#)

ARP-Request [341](#)

ATM (Asynchronous Transmission Mode) [26](#)

authentication

setup [237](#)

authentication, authorization and accounting [232](#)

authorization

setup [237](#)

authorized technician

install the Switch [29](#)

auto-crossover port [37](#)

automatic VLAN registration [115](#)

auto-MDIX port [37](#)

B

back up

configuration file [350](#)

Backup Configuration screen [350](#)

bandwidth control [165](#), [166](#)

egress rate [166](#)

ingress rate [166](#)

setup [165](#)

Bandwidth Control screen [165](#)

basic settings [81](#)

basic setup tutorial [66](#)

Basic TLV Setting screen [305](#)

binding table [242](#)
 building [246](#)
 BPDUs [146](#)
 Bridge Protocol Data Units (BPDUs) [146](#)
 broadcast storm control [167](#)

C

CDP [269](#)
 CE EMC statement [434](#)
 Certificates screen [352](#)
 certifications
 viewing [438](#)
 CFI (Canonical Format Indicator) [115](#)
 changing the password [57](#)
 Cisco Discovery Protocol, see CDP
 CIST [164](#)
 Class of Service [324](#)
 classifier [193](#)
 and QoS [193](#)
 editing [198](#)
 example [200](#)
 logging [199](#)
 match order [199](#)
 overview [193](#)
 setup [194](#), [198](#)
 status [194](#)
 viewing [198](#)
 clearance
 Switch installation [29](#)
 cloning a port, see port cloning
 cloud mode [21](#)
 cluster management [387](#)
 and switch passwords [390](#)
 cluster manager [387](#), [390](#)
 cluster member [387](#), [390](#)
 cluster member firmware upgrade [391](#)
 network example [387](#)
 setup [389](#)
 specification [387](#)
 status [388](#)
 switch models [387](#)
 VID [390](#)
 Web Configurator [391](#)
 Cluster Management Configuration screen [389](#)

cluster manager [387](#)
 Common and Internal Spanning Tree, see CIST [164](#)
 comparison table [21](#)
 configuration [320](#)
 back up [28](#)
 change running config [346](#)
 saving [58](#)
 configuration file
 backup [350](#)
 restore [349](#)
 save [346](#)
 Configure Clone screen [399](#)
 contact information
 customer support [417](#)
 copying port settings, see port cloning
 copyright [434](#)
 CoS [324](#)
 CPU management port [132](#)
 CPU protection [279](#)
 crossover Ethernet cable [37](#)
 current date [84](#)
 current time [84](#)
 custom default
 restore [59](#)
 customer support [417](#)

D

date
 current [84](#)
 daylight saving time [85](#)
 DDMI Details screen [409](#)
 DDMI screen [408](#)
 desk mounting installation [30](#)
 precautions [30](#)
 under a table [31](#)
 DHCP
 configuration options [328](#)
 Dynamic Host Configuration Protocol [328](#)
 modes [328](#)
 Relay Agent Information format [330](#)
 setup [329](#)
 DHCP Option 82 Profile screen [331](#)
 DHCP relay

- configure [73](#)
 - tutorial [70](#)
 - DHCP relay agent [429](#)
 - DHCP relay option 82 [255](#)
 - DHCP Relay screen [332](#), [334](#)
 - DHCP screen [329](#)
 - DHCP snooping [66](#), [254](#)
 - configure [255](#)
 - DHCP relay option 82 [255](#)
 - trusted ports [254](#)
 - untrusted ports [254](#)
 - DHCP snooping database [254](#)
 - DHCP Snooping Port Configure screen [68](#)
 - DHCP Status screen [329](#)
 - DHCP Unique Identifier (DUID) [428](#)
 - DHCP-assigned IP [414](#)
 - DHCPv4
 - global relay [332](#)
 - global relay example [334](#)
 - Option 82 [330](#)
 - option 82 profiles [331](#)
 - Relay Agent Information [330](#)
 - DHCPv4 relay [329](#)
 - DHCPv6
 - enable in Windows XP [431](#)
 - DHCPv6 Client Setup screen [111](#)
 - DHCPv6 relay [338](#)
 - interface-ID [338](#)
 - remote-ID [338](#)
 - DHCPv6 Relay screen [338](#)
 - diagnostics [380](#)
 - Ethernet port test [381](#)
 - ping [381](#)
 - Differentiated Service (DiffServ) [324](#)
 - DiffServ [324](#)
 - activate [325](#)
 - DS field [324](#)
 - DSCP [324](#)
 - network example [325](#)
 - PHB [324](#)
 - service level [324](#)
 - DiffServ Code Points [324](#)
 - Digital Diagnostics Monitoring Interface [408](#)
 - disclaimer [434](#)
 - disposal and recycling information
 - EU [436](#)
 - DS (Differentiated Services) [324](#)
 - DSCP [324](#)
 - what it does [324](#)
 - dual firmware images [348](#)
 - duplex mode [36](#)
 - dust plug [38](#)
 - Dynamic Host Configuration Protocol for IPv6 (DHCPv6) [428](#)
 - dynamic link aggregation [171](#)
- ## E
- egress port [135](#)
 - egress rate [166](#)
 - electrical inspection authority [42](#)
 - electrician [42](#)
 - electrostatic discharge (ESD) [38](#)
 - Environment Statement [436](#)
 - Errdisable Detect screen [283](#)
 - Errdisable Recovery screen [284](#)
 - Errdisable screen [280](#)
 - errdisable status [282](#)
 - error disable [279](#)
 - control packets [281](#)
 - CPU protection [282](#)
 - detect [283](#)
 - recovery [284](#)
 - status [280](#)
 - error-disable recovery [279](#)
 - Ethernet broadcast address [340](#), [396](#)
 - Ethernet MAC [82](#)
 - Ethernet OAM [313](#)
 - Ethernet port
 - auto-crossover [37](#)
 - auto-negotiating [36](#)
 - dual personality [37](#)
 - Ethernet port test [381](#)
 - Ethernet settings
 - default [37](#)
 - external authentication server [233](#)

F

FCC interference statement [434](#)

fiber cable

- connecting [39](#)
- removal [39](#)

file transfer using FTP

- command example [355](#)

filename convention, configuration

- file names [354](#)

filtering [143](#)

- rules [143](#)

filtering database, MAC table [393](#)

Filtering screen [143](#)

firmware

- upgrade [348](#), [391](#)
- ZyNOS [82](#)

Firmware Upgrade screen [348](#)

firmware version

- support ZON [23](#)

flow control

- back pressure [94](#)
- IEEE802.3x [94](#)

forwarding

- delay [154](#)

frames

- tagged [122](#)
- untagged [122](#)

freestanding installation

- precautions [30](#)
- procedure [29](#)

front panel [36](#)

FTP [354](#)

- file transfer procedure [355](#)
- restrictions over WAN [356](#)

full duplex

- Ethernet port [36](#)

G

GARP (Generic Attribute Registration Protocol) [115](#)

GARP timer [86](#), [115](#)

general setup [83](#)

General Setup screen [83](#)

getting help [59](#)

gigabit ports [36](#)

GMT (Greenwich Mean Time) [85](#)

gratuitous ARP [341](#)

green Ethernet [288](#)

- and uplink port [288](#)
- auto power down [288](#)
- EEE [288](#)
- short reach [288](#)

grounding

- for safety [40](#)

GVRP (GARP VLAN Registration Protocol) [116](#)

H

half duplex

- Ethernet port [36](#)

hardware features [21](#)

hardware installation [29](#)

hardware monitor [82](#)

hardware overview [36](#)

hello time [153](#)

hops [154](#)

HTTPS [374](#)

- certificates [374](#)
- implementation [374](#)
- public keys, private keys [374](#)

HTTPS Certificates screen [353](#)

HTTPS example [374](#)

I

IANA (Internet Assigned Number Authority) [423](#)

Identity Association (IA) [428](#)

IEEE 802.1x

- activate [181](#)
- re-authentication [182](#)

IEEE 802.3af PoE standard [24](#)

IEEE 802.3at High Power over Ethernet standard [23](#)

IEEE 802.3az [288](#)

IGMP

- overview [324](#)

IGMP filtering [210](#)

- profile **218**
 - IGMP leave timeout
 - fast **216**
 - normal **216**
 - IGMP snooping **210**
 - MVR **211**
 - IGMP snooping and VLANs **210**
 - IGMP throttling **216**
 - ingress port **135**
 - ingress rate **166**
 - initial setup **61**
 - Innovation, Science and Economic Development
 - Canada ICES statement **434**
 - installation
 - air circulation **29**
 - desk mounting **30**
 - desktop **29**
 - freestanding **29**
 - rack-mounting **33**
 - transceiver **38**
 - wall mounting **32**
 - installation requirements
 - wall mounting **32**
 - installation scenarios **29**
 - Interface Setup screen **100**
 - Internet Protocol version 6, see IPv6
 - IP
 - configuration **89**
 - status **88**
 - IP address **89**
 - Switch management **63**
 - IP Setup screen **65, 87**
 - IP source guard **242**
 - ARP inspection **262**
 - IP Status Detail screen **88**
 - IP subnet mask **89**
 - IPv6 **426**
 - addressing **426**
 - enable in Windows 2003 **431**
 - enable in Windows 7 **432**
 - enable in Windows Vista **431**
 - enable in Windows XP **431**
 - EUI-64 **428**
 - global address **426**
 - interface ID **428**
 - link-local address **426**
 - Neighbor Discovery Protocol **426**
 - neighbor table **402**
 - ping **426**
 - prefix **426**
 - prefix length **426**
 - unspecified address **427**
 - IPv6 cache **430**
 - IPv6 Configuration screen **104**
 - IPv6 Global Address Setup screen **108**
 - IPv6 Global Setup screen **105**
 - IPv6 interface **100**
 - DHCPv6 client **111**
 - enable **105**
 - global address **107**
 - global unicast address **103**
 - link-local address **106**
 - link-local IP **103**
 - neighbor discovery **109**
 - neighbor table **110**
 - status **102**
 - IPv6 Interface Setup screen **106**
 - IPv6 Interface Status screen **103**
 - IPv6 Link-Local Address Setup screen **107**
 - IPv6 multicast
 - status **220**
 - IPv6 Neighbor Setup screen **110**
 - IPv6 Neighbor Table screen **402**
 - IPv6 screen **101**
- ## J
- Java permission **46, 415**
 - JavaScript **46, 415**
- ## L
- L2PT **267**
 - access port **268**
 - CDP **267**
 - configuration **268**
 - encapsulation **267**
 - example **267**
 - LACP **268**
 - MAC address **267, 269**
 - mode **268**

- overview [267](#)
 - PAgP [268](#)
 - point to point [268](#)
 - STP [267](#)
 - tunnel port [268](#)
 - UDLD [268](#)
 - VTP [267](#)
 - LACP [171, 270](#)
 - system priority [176](#)
 - timeout [177](#)
 - Layer 2 protocol tunneling, see L2PT
 - LEDs [42](#)
 - limit MAC address learning [190](#)
 - link aggregation [171](#)
 - dynamic [171](#)
 - ID information [172](#)
 - setup [173](#)
 - traffic distribution algorithm [173](#)
 - traffic distribution type [175](#)
 - trunk group [171](#)
 - link aggregation (trunking)
 - example [26](#)
 - Link Aggregation Control Protocol (LACP) [171](#)
 - Link Layer Discovery Protocol [290](#)
 - LLDP [290](#)
 - basic TLV [305](#)
 - global settings [304](#)
 - local port status [294](#)
 - organization-specific TLV [306](#)
 - status of remote device [298](#)
 - TLV [290](#)
 - LLDP (Link Layer Discovery Protocol) [290](#)
 - LLDP screen [292](#)
 - LLDP-MED [291](#)
 - classes of endpoint devices [291](#)
 - example [291](#)
 - LLDP-MED Configuration screen [307](#)
 - LLDP-MED Location screen [309](#)
 - lockout [58](#)
 - Switch [58](#)
 - log message [383](#)
 - login [46](#)
 - password [57](#)
 - privilege level [364](#)
 - login account
 - administrator [363](#)
 - non-administrator [363](#)
 - login accounts [363](#)
 - configuring via Web Configurator [363](#)
 - multiple [363](#)
 - number of [363](#)
 - login password
 - edit [363](#)
 - Logins screen [363](#)
 - loop guard [264](#)
 - examples [265](#)
 - port shut down [265](#)
 - setup [266](#)
 - vs. STP [264](#)
- ## M
- MAC (Media Access Control) [82](#)
 - MAC address [82, 396](#)
 - maximum number per port [190](#)
 - MAC address learning [86, 190](#)
 - specify limit [190](#)
 - MAC Based VLAN screen [129](#)
 - MAC filter
 - and ARP inspection [262](#)
 - MAC freeze [190](#)
 - MAC table [393](#)
 - display criteria [395](#)
 - how it works [393](#)
 - sorting criteria [395](#)
 - transfer type [395](#)
 - viewing [394](#)
 - MAC-based VLAN [129](#)
 - maintenance [344](#)
 - configuration backup [350](#)
 - current configuration [345](#)
 - firmware [348](#)
 - main screen [345](#)
 - restore configuration [349](#)
 - Maintenance screen [344](#)
 - Management Information Base (MIB) [367](#)
 - management IP address [63](#)
 - management mode
 - change [22](#)
 - management port [135](#)
 - managing the Switch
 - cluster management [27](#)

- good habits [27](#)
 - NCC [27](#)
 - using FTP, see FTP [27](#)
 - using SNMP [27](#)
 - Web Configurator [27](#)
 - ZON Utility [27](#)
 - man-in-the-middle attacks [262](#)
 - max
 - age [154](#)
 - hops [154](#)
 - maximum transmission unit [398](#)
 - Maximum Transmission Unit (MTU) [103](#)
 - Mbuf (Memory Buffer) [351](#)
 - MDIX (Media Dependent Interface Crossover) [37](#)
 - Media Access Control [82](#)
 - Memory Buffer [351](#)
 - MIB
 - and SNMP [367](#)
 - supported MIBs [368](#)
 - MIB (Management Information Base) [367](#)
 - mirroring ports [169](#)
 - MLD filtering profile [225](#)
 - MLD snooping-proxy [220](#)
 - filtering [224](#)
 - filtering profile [225](#)
 - port role [222](#)
 - VLAN ID [221](#)
 - models
 - GS1920v2 [21](#)
 - monitor port [169](#)
 - mounting brackets [31](#)
 - attaching [34](#)
 - MST Instance, see MSTI [163](#)
 - MST region [163](#)
 - MSTI [163](#)
 - MSTP
 - bridge ID [157](#)
 - configuration [152](#)
 - configuration digest [158](#)
 - forwarding delay [154](#)
 - Hello Time [157](#)
 - hello time [153](#)
 - Max Age [157](#)
 - max age [154](#)
 - max hops [154](#)
 - path cost [155](#)
 - port priority [154](#)
 - revision level [154](#)
 - status [156](#)
 - MTU [398](#)
 - MTU (Multi-Tenant Unit) [85](#)
 - multicast
 - IGMP throttling [216](#)
 - IP addresses [209](#)
 - setup [213](#)
 - multicast group [218](#)
 - multicast MAC address [139](#)
 - Multi-Tenant Unit [85](#)
 - MVR [211](#)
 - configuration [226](#)
 - network example [211](#)
 - MVR (Multicast VLAN Registration) [211](#)
 - myZyxel account [22](#)
- ## N
- navigation panel [55](#)
 - NCC registration [22](#)
 - Nebula Cloud Management [22](#)
 - Nebula Control Center (NCC) [21](#)
 - Nebula setup wizard
 - select site [22](#)
 - Nebula Switch Registration screen [113](#)
 - Nebula web portal [22](#)
 - NebulaFlex for hybrid mode [21](#)
 - Neighbor Detail screen [79](#)
 - Neighbor Discovery Protocol (NDP) [429](#)
 - Neighbor screen [77](#)
 - network applications [24](#)
 - network management system (NMS) [367](#)
 - NTP (RFC-1305) [84](#)
- ## O
- OAM [313](#)
 - details [314](#)
 - discovery [313](#)
 - port configuration [313](#)
 - remote loopback [313, 319](#)

- one-time schedule [191](#)
 - Operations, Administration and Maintenance [313](#)
 - Option 82 [330](#)
 - Organizationally Unique Identifiers (OUI) [128](#)
 - Org-specific TLV Setting screen [306](#)
 - overheating
 - prevention [29](#)
- P**
- PAGP [270](#)
 - password [57](#)
 - administrator [48, 363](#)
 - change [28](#)
 - write down [28](#)
 - password change
 - via Password / SNMP link [47](#)
 - Path MTU Discovery [398](#)
 - Path MTU Table screen [398](#)
 - Per-Hop Behavior [324](#)
 - PHB [324](#)
 - ping, test connection [381](#)
 - PoE
 - PD priority [99](#)
 - power management mode [98](#)
 - power-up mode [97](#)
 - PoE (Power over Ethernet) [94](#)
 - PoE features [24](#)
 - PoE models
 - GS1920v2 [21](#)
 - PoE Setup screen [97](#)
 - PoE Status screen [95](#)
 - PoE Time Range Setup screen [97](#)
 - policy [203](#)
 - and classifier [203](#)
 - and DiffServ [202](#)
 - configuration [203](#)
 - example [205](#)
 - overview [202](#)
 - rules [202, 203](#)
 - port
 - setup [92](#)
 - speed/duplex [93](#)
 - Port Aggregation Protocol, see PAGP
 - port authentication [179](#)
 - guest VLAN [184](#)
 - IEEE802.1x [181](#)
 - MAC authentication [182](#)
 - method [180](#)
 - port cloning [399, 400](#)
 - advanced settings [399, 400](#)
 - basic settings [399, 400](#)
 - port details [405](#)
 - Port isolation
 - Setting Wizard [135](#)
 - port mirroring [169](#)
 - port redundancy [171](#)
 - Port screen
 - DHCPv4 Global Relay [333](#)
 - DHCPv4 VLAN [336](#)
 - port security [189](#)
 - address learning [190](#)
 - limit MAC address learning [190](#)
 - setup [189](#)
 - Port Setup screen [92](#)
 - port status [404](#)
 - port details [405](#)
 - port utilization [410](#)
 - port utilization [410](#)
 - Port VID (PVID) [63](#)
 - port VLAN ID, see PVID [122](#)
 - port VLAN trunking [116](#)
 - port-based VLAN [132](#)
 - all connected [135](#)
 - configure [132](#)
 - port isolation [135](#)
 - settings wizard [135](#)
 - ports
 - diagnostics [381, 382](#)
 - mirroring [169](#)
 - standby [172](#)
 - power
 - voltage [83](#)
 - power connections [42](#)
 - power connector [42](#)
 - Power Sourcing Equipment (PSE) [23](#)
 - power status [83](#)
 - Powered Device (PD) [23](#)
 - powered device (PD) [94](#)
 - Power-over-Ethernet (PoE) [23](#)

PPPoE IA [271](#)
 agent sub-options [273](#)
 configuration [273](#)
 drop PPPoE packets [275](#)
 port state [273](#)
 sub-option format [272](#)
 tag format [271](#)
 trusted ports [273](#)
 untrusted ports [273](#)
 VLAN [277](#)
 PPPoE Intermediate Agent [271](#)
 prefix delegation [429](#)
 priority level
 queue assignment [87](#)
 priority queue assignment [87](#)
 priority, and OSPF [323](#)
 product registration [438](#)
 protocol based VLAN
 configuration example [135](#)
 PVID [115](#)

Q

QoS [324](#)
 and classifier [193](#)
 Quality of Service [324](#)
 queue weight [207](#)
 queuing [206, 207](#)
 SPQ [206](#)
 WRR [206](#)
 queuing method [206, 208](#)

R

rack-mounting [33](#)
 installation requirements [34](#)
 precautions [34](#)
 RADIUS [233](#)
 advantages [233](#)
 and tunnel protocol attribute [240](#)
 setup [233](#)
 Rapid Spanning Tree Protocol (RSTP) [145](#)
 rear panel [40](#)
 reboot

 load configuration [346](#)
 reboot system [346](#)
 recurring schedule [191](#)
 registration
 product [438](#)
 Regulatory Notice and Statement [434](#)
 remote management [365](#)
 service [366](#)
 trusted computers [366](#)
 RESET button [59](#)
 resetting [59, 345, 347](#)
 to custom default settings [347](#)
 to factory default settings [345, 347](#)
 restore
 configuration [28](#)
 RESTORE button [59](#)
 restore configuration [349](#)
 restoring configuration [59](#)
 RFC 3164 [384](#)
 Round Robin Scheduling [206](#)
 Router Advertisement (RA) [429](#)
 RSTP
 configuration [150](#)
 rubber feet
 attach [30](#)
 running configuration [345](#)
 erase [345](#)
 reset [345](#)

S

safety precautions
 using the Switch [29](#)
 safety warnings [435](#)
 save configuration [58, 346](#)
 Save link [58](#)
 schedule
 one-time [191](#)
 recurring [191](#)
 type [192](#)
 screw anchors
 using [32](#)
 Secure Shell, see SSH
 service access control [364](#)

- service port [365](#)
- SFP/SFP+ slot [37](#)
- Simple Network Management Protocol, see SNMP
- Small Form-factor Pluggable (SFP) [37](#)
- SNMP [367](#)
 - agent [367](#)
 - and MIB [367](#)
 - authentication [362](#)
 - communities [48, 359](#)
 - management model [367](#)
 - manager [367](#)
 - MIB [368](#)
 - network components [367](#)
 - object variables [367](#)
 - protocol operations [367](#)
 - security [362](#)
 - security level [362](#)
 - setup [358](#)
 - traps [359](#)
 - users [361](#)
 - version 3 and security [367](#)
 - versions supported [367](#)
- SNMP traps [368](#)
 - supported [368, 370, 372](#)
- SPQ (Strict Priority Queuing) [206](#)
- SSH
 - encryption methods [373](#)
 - how it works [372](#)
 - implementation [373](#)
- SSH (Secure Shell) [372](#)
- SSL (Secure Socket Layer) [374](#)
- standalone mode [21](#)
- standby ports [172](#)
- static MAC address [137](#)
- static MAC forwarding [137](#)
- Static MAC Forwarding screen [137](#)
- static multicast forwarding [139](#)
- Static Multicast Forwarding screen [140](#)
- static route [320](#)
 - enable [321](#)
 - metric [321](#)
- static VLAN [120](#)
 - control [121](#)
 - tagging [121](#)
- Static VLAN screen [62](#)
- status [53, 75](#)
 - MSTP [156](#)
 - port [404](#)
 - power [83](#)
 - STP [149](#)
 - VLAN [117](#)
- Status screen [75](#)
- STP [269](#)
 - bridge ID [149, 161](#)
 - bridge priority [151, 159](#)
 - designated bridge [146](#)
 - edge port [152, 160](#)
 - forwarding delay [151](#)
 - Hello BPDU [146](#)
 - Hello Time [149, 151, 159, 161](#)
 - how it works [146](#)
 - Max Age [149, 151, 159, 161](#)
 - path cost [146, 152, 160](#)
 - port priority [152, 160](#)
 - port role [150, 162](#)
 - port state [146, 150, 161](#)
 - root port [146](#)
 - status [148, 149](#)
 - terminology [146](#)
 - vs. loop guard [264](#)
- STP Path Cost [146](#)
- straight-through Ethernet cable [37](#)
- subnet based VLANs [123](#)
- subnet masking [428](#)
- Switch
 - DHCP client [46](#)
 - fanless-type usage precaution [29](#)
 - fan-type usage precaution [29](#)
- switch lockout [58](#)
- Switch reset [59](#)
- Switch Setup screen [86](#)
- Switch's QR code [23](#)
- syslog [263, 384](#)
 - protocol [384](#)
 - settings [384](#)
 - setup [384](#)
 - severity levels [384](#)
- Syslog Setup screen [384](#)
- System Info screen [81](#)
- system reboot [346](#)

T

TACACS+ [233](#)
 advantages [233](#)
 setup [235](#)

tag-based VLAN
 example [27](#)

tagged VLAN [114](#)

Tech-Support [350](#)
 log enhancement [350](#)

Tech-Support screen [350](#)

temperature indicator [83](#)

time
 current [84](#)
 daylight saving [85](#)
 format [84](#)

Time (RFC-868) [84](#)

time range [191](#)

time server [84](#)

time service protocol [84](#)

ToS [324](#)

trademarks [438](#)

transceiver
 connection interface [38](#)
 connection speed [38](#)
 installation [38](#)
 removal [39](#)

transceiver MultiSource Agreement (MSA) [37](#)

transceivers [37](#)

Trap Group screen [359](#)

traps
 destination [359](#)

troubleshooting [74](#)

trunk group [171](#)

trunking [171](#)

trusted ports
 ARP inspection [263](#)
 DHCP snooping [254](#)
 PPPoE IA [273](#)

tunnel protocol attribute
 and RADIUS [240](#)

tutorial
 DHCP snooping [66](#)

tutorials
 basic setup [66](#)

Type of Service [324](#)

U

UDLD [270](#)

UniDirectional Link Detection, see UDLD

untrusted ports
 ARP inspection [263](#)
 DHCP snooping [254](#)
 PPPoE IA [273](#)

uplink connection
 super-fast [25](#)

User Information screen
 SNMP [361](#)

user name [47](#)
 default [47](#)

user profiles [233](#)

UTC (Universal Time Coordinated) [85](#)

V

Vendor ID Based VLAN screen [131](#)

Vendor Specific Attribute, see VSA [239](#)

ventilation holes [29](#)

VID [90](#), [118](#), [119](#)
 number of possible VIDs [115](#)
 priority frame [115](#)

VID (VLAN Identifier) [115](#)

Virtual Local Area Network [85](#)

VLAN [85](#)
 acceptable frame type [122](#)
 and IGMP snooping [210](#)
 automatic registration [115](#)
 creation [61](#), [71](#)
 ID [114](#)
 ingress filtering [122](#)
 introduction [85](#), [114](#)
 number of VLANs [118](#)
 port number [119](#)
 port settings [121](#)
 port-based [135](#)
 port-based VLAN [132](#)
 port-based, isolation [135](#)
 port-based, wizard [135](#)

- PVID [122](#)
- static VLAN [120](#)
- status [117](#), [118](#), [119](#)
- subnet based [123](#)
- tagged [114](#)
- terminology [116](#)
- trunking [116](#), [123](#)
- type [86](#), [117](#)
- VLAN (Virtual Local Area Network) [85](#)
- VLAN ID [114](#)
- VLAN number [89](#)
- VLAN Setting screen [337](#)
 - DHCPv4 [335](#)
- VLAN terminology [116](#)
- VLAN trunking [123](#)
- VLAN Trunking Protocol, see VTP
- VLAN-unaware devices [62](#)
- voice VLAN [127](#)
- Voice VLAN Setup screen [128](#)
- VSA [239](#)
- VTP [269](#)

W

- wall mounting [32](#)
 - distance above the floor [32](#)
 - distance between holes [32](#)
- warranty [438](#)
 - note [438](#)
- Web browser pop-up window [46](#), [415](#)
- Web Configurator
 - getting help [59](#)
 - home [53](#)
 - home screen [53](#)
 - login [46](#)
 - logout [59](#)
 - navigating components [53](#)
 - navigation panel [54](#)
 - online help [59](#)
 - usage prerequisite [46](#)
- weight [207](#)
- Windows OS version
 - check [49](#)
- WRR (Weighted Round Robin Scheduling) [206](#)

Z

- ZDP [49](#)
- ZON (Zyxel One Network) [438](#)
- ZON Utility [49](#)
 - compatible OS [49](#)
 - fields description [52](#)
 - icon description [52](#)
 - installation requirements [49](#)
 - introduction [23](#)
 - minimum hardware requirements [49](#)
 - network adapter select [51](#)
 - password prompt [52](#)
 - run [49](#)
 - supported firmware version [50](#)
 - supported models [50](#)
 - Switch IP address [46](#)
- ZON utility
 - use for troubleshooting [414](#)
- ZyNOS (Zyxel Network Operating System) [354](#), [438](#)
- Zyxel AP Configurator (ZAC) [52](#)
- Zyxel Discovery Protocol (ZDP) [49](#)
- Zyxel Nebula Mobile App
 - register the Switch [22](#)
- Zyxel One Network (ZON) Utility [23](#)