

Quad Monitor Mount | Full Motion | Premium



Actual product may vary from photos

User Manual SKU#: ARMQUADPS

For the latest information and specifications visit
www.startech.com/ARMQUADPS

Manual Revision: 09/16/2019

Compliance Statements

Use of Trademarks, Registered Trademarks, and other Protected Names and Symbols

This manual may make reference to trademarks, registered trademarks, and other protected names and/or symbols of third-party companies not related in any way to StarTech.com. Where they occur these references are for illustrative purposes only and do not represent an endorsement of a product or service by StarTech.com, or an endorsement of the product(s) to which this manual applies by the third-party company in question. Regardless of any direct acknowledgement elsewhere in the body of this document, StarTech.com hereby acknowledges that all trademarks, registered trademarks, service marks, and other protected names and/or symbols contained in this manual and related documents are the property of their respective holders.

Warning Statements

- Make sure that you assemble this product according to the instructions.
- Do not exceed the weight capacity of this product. Overloading this product might result in injury or property damage. This product can support the following weight: 99.2 lb. (45 kg).
- This product is intended for indoor use only and should not be used outdoors.

Varningsmeddelanden

- Se till att du monterar produkten i enlighet med instruktionerna.
- Överskrid inte produktens viktkapacitet. Överbelastning av produkten kan orsaka skada på person eller egendom. Denna produkt har stöd för följande vikter: 45 kg.
- Produkten är endast avsedd för användning inomhus och ska inte användas utomhus.

Avertissements

- Assemblez ce produit conformément aux instructions.
- Ne dépassez pas la capacité pondérale du produit. Une surcharge du produit peut entraîner des blessures ou des dommages matériels. Ce produit peut supporter 45 kg.
- Ce produit est uniquement destiné à une utilisation en intérieur et ne doit pas être utilisé à l'extérieur.

Warnhinweise

- Beachten Sie bei der Montage dieses Produkts die Montageanweisungen.
- Überschreiten Sie nicht die Tragkraft dieses Produkts. Ein Überladen dieses Produkts kann zu Verletzungen oder zur Beschädigung des Produkts führen. Dieses Produkt ist für folgendes Gewicht geeignet: 45 kg.
- Dieses Produkt ist nur zum Gebrauch in Innenräumen vorgesehen und sollte nicht im Freien verwendet werden.

Dichiarazioni di avvertenza

- Assicurarsi di Assemblare il prodotto secondo le istruzioni.
- Non superare la capacità di carico del prodotto. Il sovraccarico del prodotto potrebbe causare danni o lesioni. Il prodotto è in grado di supportare i seguenti pesi: 45 kg.
- Il prodotto è destinato all'uso in ambienti interni. Se ne sconsiglia l'impiego in ambienti esterni.

Mensagens de aviso

- Certifique-se de que monta este produto de acordo com as instruções.
- Não exceda a capacidade de peso deste produto. Sobrecarregar este produto pode resultar em ferimentos ou danos de propriedade. Este produto pode suportar o seguinte peso: 45 kg.
- Este produto destina-se apenas a uma utilização no interior e não deve ser utilizado no exterior.

Advertencias de uso

- Asegúrese de ensamblar este producto según las instrucciones.
- Asegúrese de no exceder la capacidad de peso de este producto. La sobrecarga de este producto puede causar lesiones personales o daños en la propiedad. Este producto tiene capacidad para el siguiente peso: 45 kg.
- El uso de este producto es solo para interiores y no debe utilizarse en exteriores.

Waarschuwingen

- Zorg dat u dit product volgens de instructies in elkaar zet.
- Overschrijd de maximale capaciteit van dit product niet. Overbelasting van dit product kan letsel of materiële schade veroorzaken. Dit product ondersteunt het volgende gewicht: 45 kg.
- Dit product is alleen bedoeld voor binnengebruik en mag niet buiten worden gebruikt.

注意

- 必ず取扱説明書に従って本製品の組み立てを行って下さい。
- 本製品で定められた最大積載重量を超えないようにして下さい。最大積載重量をオーバーした場合、怪我をする恐れや器物破損の恐れがあります。本製品は、モニター1台あたり45kgまで支持できます。
- 本製品は、室内での使用を想定しています。戸外では使用しないで下さい。

Safety Statements

Safety Measures

- Cables (including power and charging cables) should be placed and routed to avoid creating electric, tripping or safety hazards.

Mesures de sécurité

- Les câbles (y compris les câbles d'alimentation et de chargement) doivent être placés et acheminés de façon à éviter tout risque électrique, de chute ou de sécurité

安全対策

- ケーブル(電源ケーブルと充電ケーブルを含む)は、適切な配置と引き回しを行い、電気障害やつまづきの危険性など、安全上のリスクを回避するようにしてください。

Misure di sicurezza

- I cavi (inclusi i cavi di alimentazione e di ricarica) devono essere posizionati e stesi in modo da evitare pericoli di inciampo, rischi di scosse elettriche o pericoli per la sicurezza.

Säkerhetsåtgärder

- Kablar (inklusive elkablar och laddningskablar) ska dras och placeras på så sätt att risk för snubblingsolyckor och andra olyckor kan undvikas.

Table of Contents

Compliance Statements	1
Warning Statements	2
Safety Statements	4
Product Diagram	6
Product Dimension	7
Product Rotation	8
Product Information	9
Specifications.....	9
Package Contents	10
Installation	13
Using the Grommet Mount	13
Using the C-Clamp.....	17
Attaching the Monitor Mount.....	21
Attaching a Monitor Using the VESA Mount.....	24
Attaching the Monitor Mount	25
Removing the Monitor Mount	26
Adjusting the Monitor Tilt	27
Routing the Cables.....	27

Product Diagram

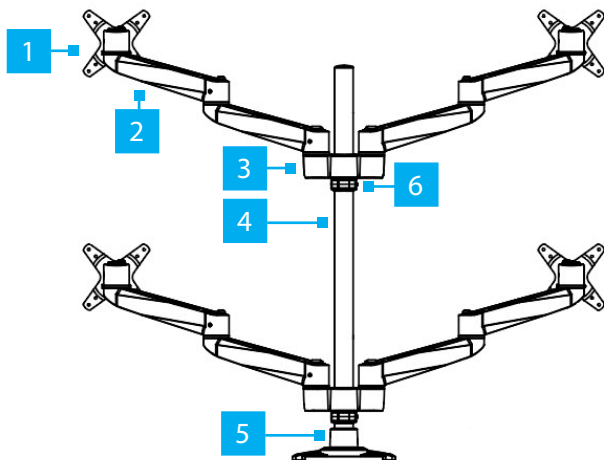

1	<i>Monitor Mount (x 4)</i>	4	<i>Support Pole</i>
2	<i>Swivel Arm (x 8)</i>	5	<i>C-Clamp</i>
3	<i>Swivel Arm Shoulder (x 2)</i>	6	<i>Cable-Management Clip</i>

Product Dimension

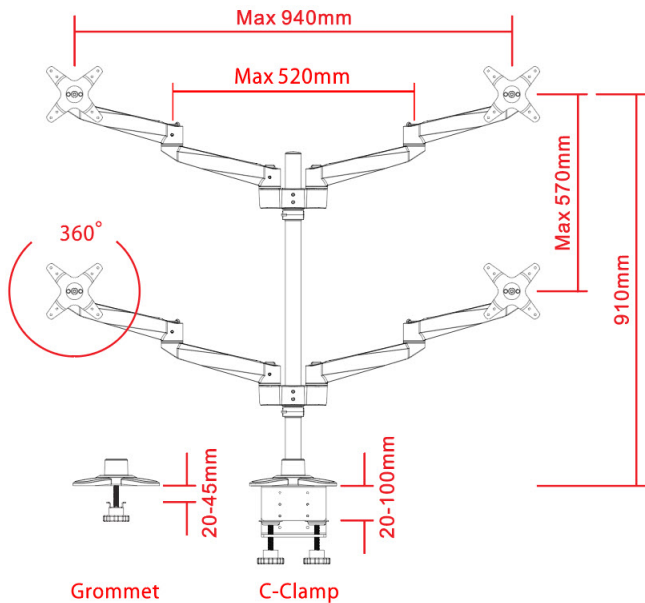

Product Rotation

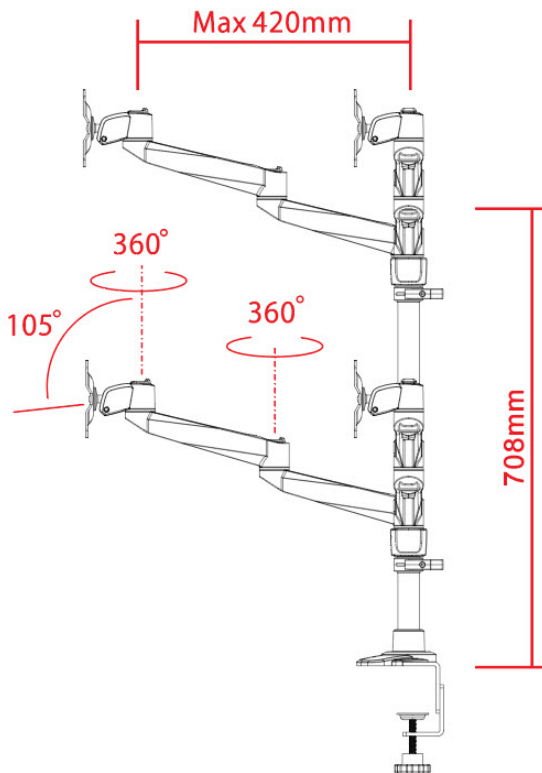

To view manuals, videos, drivers, downloads, technical drawings, and more visit www.startech.com/support

Product Information

Specifications

Type of Measurement	Measurement
VESA Mounting Hole Pattern	75x75 100x100
Tilt	+90° to -15°
Screen Size	Maximum 27 in. (685 mm)
Rotate	360°
Swivel	360°
Weight/Load Capacity	99.2 lb. (45 kg)
Arm Extension	16.53 in. (420 mm)

Package Contents



Swivel Arms

Qty: Eight



VESA Monitor Mounts

Qty: Four

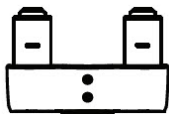

Swivel Arm Shoulder

Qty: Two



*Support Pole w/Decorative
Plate*

Qty: One



M3 Hex Key

Qty: Four



EVA Pad

Qty: One



Thumb Screws

Qty: Eight



Lower Base

Qty: One



Grommet Base

Qty: One



Grommet Clip

Qty: One



Upper Base

Qty: One



M5 x 14 mm Screw

Qty: Ten

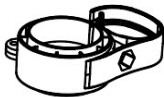

Cable Management Clip

Qty: Four

Installation

Using the Grommet Mount

1. Align the **Mounting Holes** in the **Grommet Base** with the **Mounting Holes** on the **Support Pole**.
2. Insert four **M5 x 14 mm Screws** through the **Mounting Holes** on the **Grommet Base** and into the **Mounting Holes** on the **Support Pole**.
3. Using the **M3 Hex Keys**, tighten the four **M5 x 14 mm Screws**.

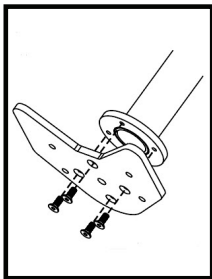

Attaching the Grommet Base to the Support Pole

4. Slide the four **Pegs** on the **Decorative Plate** (attached to the Support Pole) into the four **Peg Holes** on the **Grommet Base**.

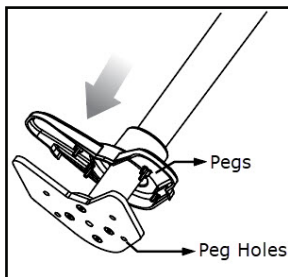

Sliding the Pegs into the Peg Holes

5. Remove the backing from the **EVA Pad** and apply the adhesive side of the **EVA Pad** to the bottom of the **Grommet Base**, to cover the four **M5 x 14 mm Screws** to protect the mounting surface.

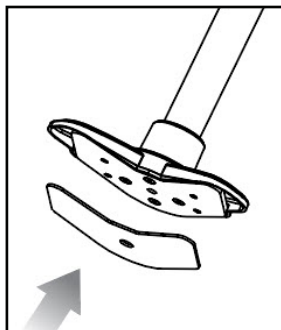

Applying the EVA Pad

6. You need to remove one of the **Hand Screws** from the **Lower Base** to use with the **Grommet Base**. Use a **Phillips Head Screwdriver** (sold separately) to remove the **Screw** from the **Hand Screw** on the **Lower Base**.

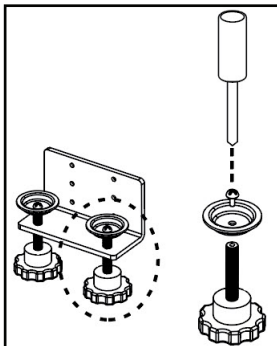

Removing a Hand Screw from the Lower Base

7. Slide the **Grommet Clip** over the **Hand Screw**.

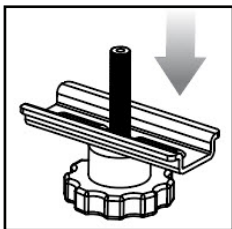

Sliding the Grommet Clip onto the Hand Screw

- Align the **Support Pole with Grommet Assembly** with the **Grommet Hole** on the **Mounting Surface**.

Note: The size of the **Grommet Hole** should be between .39" - 3" (10 - 80 mm).

The thickness of the **Mounting Surface** should be between .78" - 1.7" (20 - 45 mm).

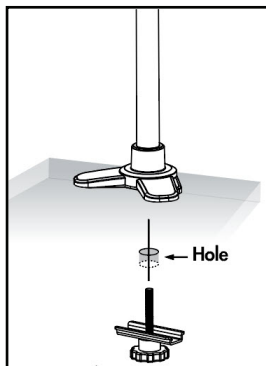

Aligning the Support Pole With the Grommet Hole

- Insert the **Hand Screw with Grommet Clip** through the **Grommet Hole** in the **Mounting Surface** and into the **Grommet Base**.
- Hand tighten the **Hand Screw**, securing the **Support Pole** in place.

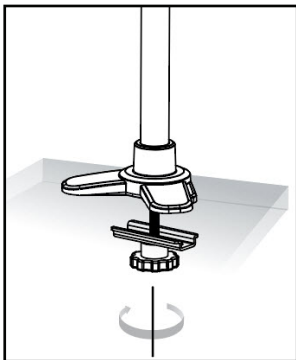

Hand Tightening the Hand Screw

Using the C-Clamp

1. Align the **Mounting Holes** in the **Upper Base** of the **C-Clamp** with the **Mounting Holes** on the **Support Pole**.
2. Insert four **M5 x 14 mm Screws** through the **Mounting Holes** on the **Upper Base** and into the **Mounting Holes** on the **Support Pole**.

- Using the **M3 Hex Key**, tighten the four **M5 x 14 mm Screws**.

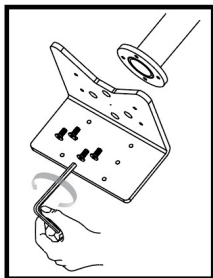

Attaching the Upper Base to the Support Pole

- Slide the four **Pegs** on the **Decorative Plate** (attached to the **Support Pole**) into the four **Peg Holes** on the **Upper Base**.

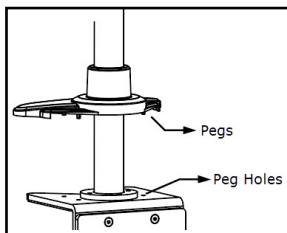

Sliding the Pegs into the Peg Holes

- Remove the backing from the **EVA Pad** and apply the adhesive side of the **EVA Pad** to the bottom of the **Upper Base**, covering the four **M5 x 14 mm Screws** to protect the mounting surface.

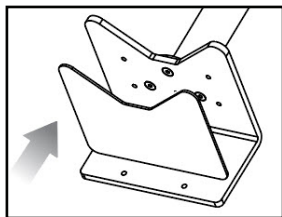

Applying the EVA Pad

- Measure the width of the mounting surface and adjust the width of the **C-Clamp** by aligning the holes on the **Lower Base** with the holes on the **Upper Base**.
- When the desired width is achieved, insert the six **M5 x 14 mm Screws** through the **Lower Base** and into the **Upper Base**.

Note: *The thickness of the mounting surface must be between .79" - 3.5" (20 mm - 90 mm).*

- Use the **M3 Hex Key** to tighten the **M5 x 14 mm Screws**.

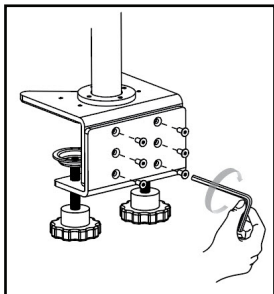

Tightening the M5 x 14 mm Screws

9. While supporting the weight of the **Support Pole** slide the **C-Clamp** over the edge of the mounting surface.

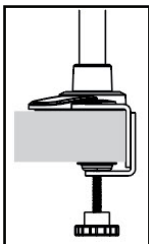

Sliding C-Clamp over the Edge of Mounting Surface

10. Using the **Hand Screws** tighten the **C-Clamp** until the **C-Clamp** is pressed tightly against the mounting surface.

Attaching the Monitor Mount

When the **Desk Mount** has been mounted to the mounting surface either by using the **C-Clamp** or **Grommet**:

1. Slide two of the **Cable Management Clip** onto the **Support Pole**.
2. Position the second **Cable Management Clip** at the (approximate) height you want the first row of **Monitor** to sit.
3. Tighten the **Cable Management Clip** using the **Adjustment Screw** located on the side of the **Cable Management Clip**, using the **M3 Hex Key**. Be careful not to over-tighten the **Cable Management Clip**.
4. Slide the **Swivel Arm Shoulder** onto the **Support Pole**, so that it is resting on the second **Cable-Management Clip**.

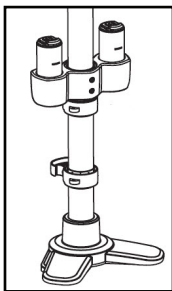

Sliding the Monitor Shoulder over the Support Pole

5. Tighten the **Swivel Arm Shoulder** using the **Adjustment Screw** located on the side of the **Swivel Arm Shoulder**, using the **M3 Hex Key**. Be careful not to over-tighten the **Swivel Arm Shoulder**.

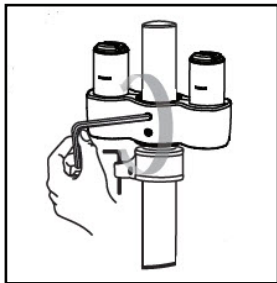

Tightening the Swivel Arm Shoulder

6. Repeat steps 1 - 4 to install the second **Swivel Arm Shoulder**.

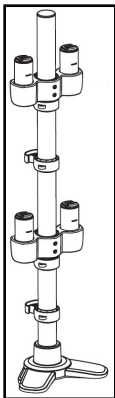

Both Swivel Arm Shoulders Installed

7. Slide the **Mounting Hole** on **Swivel Arm 1** over the **Mounting Peg** on the **Swivel Arm Shoulder** until it clicks into place.

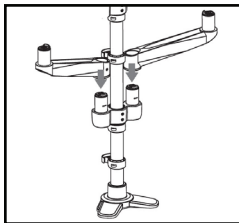

Sliding the Swivel Arms into Place

- Repeat step 7 to install **Swivel Arms 2, 3, and 4**.
- To install the second row of **Swivel Arms (5, 6, 7, and 8)**, slide the **Mounting Hole** on **Swivel Arm 5** over the **Mounting Peg** on **Swivel Arm 1** until it clicks into place.

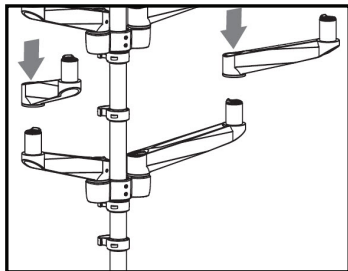

Attaching the Swivel Arm

- Repeat step 9 to install **Swivel Arms 6, 7, and 8**.

Attaching a Monitor Using the VESA Mount

- Align the **Mounting Holes (x 4)** on the **Monitor Mount** with the mounting holes on the back of the **Monitor**.

Note: *When mounting the VESA mount the orientation of the **Monitor** is important.*

- Insert the **Thumb Screws** through the **Monitor Mount** and into the back of the **Monitor**.

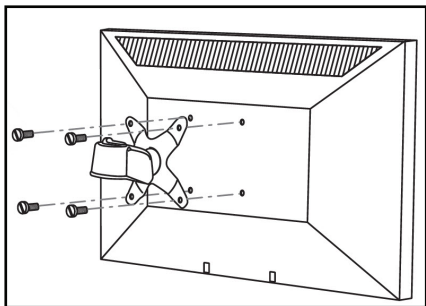

Mounting the Monitor Using the VESA Mount

- Using your fingers, tighten the **Thumb Screws**.

Warning! Do not over-tighten the **Thumb Screws**. If you encounter resistance while you are tightening the **Thumb Screws**, stop tightening. Failure to do so could result in damage to the monitor.

- Complete steps 1 - 3 to mount the remaining **Monitors**.

Attaching the Monitor Mount

Note: Attaching the **Monitor Mount** may require two people.

- While supporting the weight of the **Monitor**, carefully slide the **Mounting Hole** on the **Monitor Mount** over the **Mounting Peg** on the **Swivel Arm** until it clicks into place.

2. Using the **Hex Keys**, adjust the swivel tension of the **Monitor Mount** by loosening or tightening the **Hex Screws** located on the **Monitor Mount** next to the **Mounting Hole**.
3. Repeat Steps 1 - 2 to attach the remaining **Monitor Mounts**.

Removing the Monitor Mount

1. Slide the **Thumb Clip** to disengaging the locking mechanism.

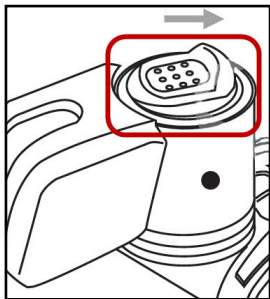

Sliding the Thumb Clip towards the Monitor Mount

2. While holding the **Thumb Clip** and the weight of the **Monitor Mount**, lift the **Monitor Mount** up, sliding the **Mounting Peg** out of the **Mounting Hole**.

Adjusting the Monitor Tilt

- While supporting the weight of the **Monitor**, use the **Hex Key** (included) to loosen or tighten the **Hex Screw** on the side of the **Monitor Mount**, until the tension can hold the weight of the **Monitor** but it is still adjustable.

Note: *The screw cap located on the opposite side of the **Hex Screw** is not used for tilt adjustments.*

Routing the Cables

The **Monitor Mount** comes with a **Cable-Management System** that can be used to run the monitor cables down the mounting arms.

Note: *Make sure that the cables are unplugged before you route them through the **Cable-Management System**.*

1. Thread the **Cable** through the hole in the **Swivel Arms**.
2. Run the **Cable** through the **Cable-Management Clip** on the side of the **Support Pole**.
3. Repeat steps 1 - 2 for any additional **Monitors**.

Warranty Information

This product is backed by a ten-year warranty.

For further information on product warranty terms and conditions, please refer to www.startech.com/warranty.

Limitation of Liability

In no event shall the liability of StarTech.com Ltd. and StarTech.com USA LLP (or their officers, directors, employees or agents) for any damages (whether direct or indirect, special, punitive, incidental, consequential, or otherwise), loss of profits, loss of business, or any pecuniary loss, arising out of or related to the use of the product exceed the actual price paid for the product.

Some states do not allow the exclusion or limitation of incidental or consequential damages. If such laws apply, the limitations or exclusions contained in this statement may not apply to you.

Hard-to-find made easy. At StarTech.com, that isn't a slogan. It's a promise.

StarTech.com is your one-stop source for every connectivity part you need. From the latest technology to legacy products — and all the parts that bridge the old and new — we can help you find the parts that connect your solutions.

We make it easy to locate the parts, and we quickly deliver them wherever they need to go. Just talk to one of our tech advisors or visit our website. You'll be connected to the products you need in no time.

Visit www.startech.com for complete information on all StarTech.com products and to access exclusive resources and time-saving tools.

StarTech.com is an ISO 9001 Registered manufacturer of connectivity and technology parts. StarTech.com was founded in 1985 and has operations in the United States, Canada, the United Kingdom and Taiwan servicing a worldwide market.

Reviews

Share your experiences using StarTech.com products, including product applications and setup, what you love about the products, and areas for improvement.

StarTech.com Ltd.

45 Artisans Cres.
London, Ontario
N5V 5E9
Canada

FR: startech.com/fr
DE: startech.com/de

StarTech.com LLP

2500 Creekside Pkwy.
Lockbourne, Ohio
43137
U.S.A.

ES: startech.com/es
NL: startech.com/nl

StarTech.com Ltd.

Unit B, Pinnacle
15 Gowerton Rd.,
Brackmills
Northampton
NN4 7BW
United Kingdom

IT: startech.com/it
JP: startech.com/jp