

**ASUS®**

**VG2791R Series  
LCD Monitor**

**User Guide**

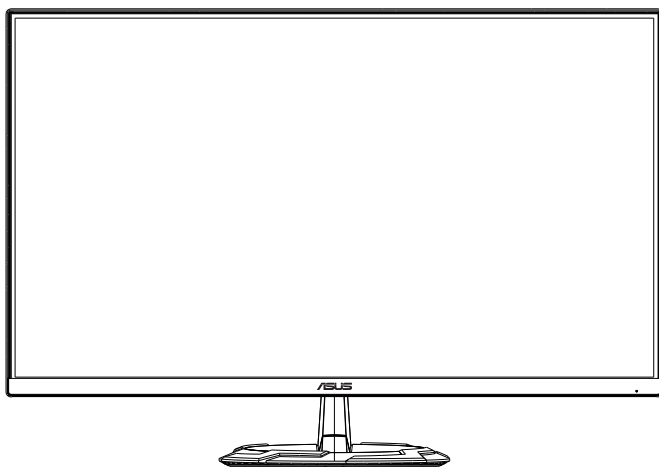

**HDMI™**  
HIGH-DEFINITION MULTIMEDIA INTERFACE

# Table of contents

Notices.....	iii
Care & Cleaning.....	v
1.1 Welcome!.....	1-1
1.2 Package contents.....	1-1
1.3 Assembling the monitor.....	1-2
1.4 Outline dimension.....	1-2
1.5 Connect cables.....	1-3
1.5.1 Rear of the LCD monitor.....	1-3
1.6 Monitor introduction.....	1-4
1.6.1 Using the Controls button.....	1-4
2.1 Detaching the arm/stand (for wall mount).....	2-1
2.2 Adjusting the monitor.....	2-2
3.1 OSD (On-Screen Display) menu.....	3-1
3.1.1 How to reconfigur.....	3-1
3.1.2 OSD Function Introduction.....	3-2
3.2 Specification.....	3-11
3.3 Troubleshooting (FAQ).....	3-12
3.4 Supported Timing List.....	3-13

Copyright © 2020 ASUSTeK COMPUTER INC. All Rights Reserved.

No part of this manual, including the products and software described in it, may be reproduced, transmitted, transcribed, stored in a retrieval system, or translated into any language in any form or by any means, except documentation kept by the purchaser for backup purposes, without the express written permission of ASUSTeK COMPUTER INC. ("ASUS").

Product warranty or service will not be extended if: (1) the product is repaired, modified or altered, unless such repair, modification or alteration is authorized in writing by ASUS; or (2) the serial number of the product is defaced or missing.

ASUS PROVIDES THIS MANUAL "AS IS" WITHOUT WARRANTY OF ANY KIND, EITHER EXPRESS OR IMPLIED, INCLUDING BUT NOT LIMITED TO THE IMPLIED WARRANTIES OR CONDITIONS OF MERCHANTABILITY OR FITNESS FOR A PARTICULAR PURPOSE. IN NO EVENT SHALL ASUS, ITS DIRECTORS, OFFICERS, EMPLOYEES OR AGENTS BE LIABLE FOR ANY INDIRECT, SPECIAL, INCIDENTAL, OR CONSEQUENTIAL DAMAGES (INCLUDING DAMAGES FOR LOSS OF PROFITS, LOSS OF BUSINESS, LOSS OF USE OR DATA, INTERRUPTION OF BUSINESS AND THE LIKE), EVEN IF ASUS HAS BEEN ADVISED OF THE POSSIBILITY OF SUCH DAMAGES ARISING FROM ANY DEFECT OR ERROR IN THIS MANUAL OR PRODUCT.

SPECIFICATIONS AND INFORMATION CONTAINED IN THIS MANUAL ARE FURNISHED FOR INFORMATIONAL USE ONLY, AND ARE SUBJECT TO CHANGE AT ANY TIME WITHOUT NOTICE, AND SHOULD NOT BE CONSTRUED AS A COMMITMENT BY ASUS. ASUS ASSUMES NO RESPONSIBILITY OR LIABILITY FOR ANY ERRORS OR INACCURACIES THAT MAY APPEAR IN THIS MANUAL, INCLUDING THE PRODUCTS AND SOFTWARE DESCRIBED IN IT.

Products and corporate names appearing in this manual may or may not be registered trademarks or copyrights of their respective companies, and are used only for identification or explanation and to the owners' benefit, without intent to infringe.

# Notices

## Federal Communications Commission Statement

This device complies with Part 15 of the FCC Rules. Operation is subject to the following two conditions:

- This device may not cause harmful interference, and
- This device must accept any interference received including interference that may cause undesired operation.

This equipment has been tested and found to comply with the limits for a Class B digital device, pursuant to Part 15 of the FCC Rules. These limits are designed to provide reasonable protection against harmful interference in a residential installation. This equipment generates, uses and can radiate radio frequency energy and, if not installed and used in accordance with the instructions, may cause harmful interference to radio communications. However, there is no guarantee that interference will not occur in a particular installation. If this equipment does cause harmful interference to radio or television reception, which can be determined by turning the equipment off and on, the user is encouraged to try to correct the interference by one or more of the following measures:

- Reorient or relocate the receiving antenna.
- Increase the separation between the equipment and receiver.
- Connect the equipment to an outlet on a circuit different from that to which the receiver is connected.
- Consult the dealer or an experienced radio/TV technician for help.

## Canadian Department of Communications Statement

This digital apparatus does not exceed the Class B limits for radio noise emissions from digital apparatus set out in the Radio Interference Regulations of the Canadian Department of Communications.

This class B digital apparatus complies with Canadian ICES-003.



# Safety information

- Before setting up the monitor, carefully read all the documentation that came with the package.
- To prevent fire or shock hazard, never expose the monitor to rain or moisture.
- Never try to open the monitor cabinet. The dangerous high voltages inside the monitor may result in serious physical injury.
- If the power supply is broken, do not try to fix it by yourself. Contact a qualified service technician or your retailer.
- Before using the product, make sure all cables are correctly connected and the power cables are not damaged. If you detect any damage, contact your dealer immediately.
- Slots and openings on the back or top of the cabinet are provided for ventilation. Do not block these slots. Never place this product near or over a radiator or heat source unless proper ventilation is provided.
- The monitor should be operated only from the type of power source indicated on the label. If you are not sure of the type of power supply to your home, consult your dealer or local power company.
- Use the appropriate power plug which complies with your local power standard.
- Do not overload power strips and extension cords. Overloading can result in fire or electric shock.
- Avoid dust, humidity, and temperature extremes. Do not place the monitor in any area where it may become wet. Place the monitor on a stable surface.
- Unplug the unit during a lightning storm or if it will not be used for a long period of time. This will protect the monitor from damage due to power surges.
- Never push objects or spill liquid of any kind into the slots on the monitor cabinet.
- If you encounter technical problems with the monitor, contact a qualified service technician or your retailer.
- Adjustment of the volume control as well as the equalizer to other settings than the center position may increase the ear-/headphones output voltage and therefore the sound pressure level.
- The adapter is only used for this monitor, do not use it for other purpose.
- Please make sure to connect the adapter to main socket with protective earthing. Your device uses one of the following power supplies:
  - Manufacturer: Delta Electronics Inc., Model: ADP-40KD BB



This symbol of the crossed out wheeled bin indicates that the product (electrical, electronic equipment, and mercury-containing button cell battery) should not be placed in municipal waste. Please check local regulations for disposal of electronic products.

## WARNING

Usage of other than specific head- or earphones can result in hearing loss due to excessive sound pressures.

## Care & Cleaning

- Before you lift or reposition your monitor, it is better to disconnect the cables and power cord. Follow the correct lifting techniques when positioning the monitor. When lifting or carrying the monitor, grasp the edges of the monitor. Do not lift the display by the stand or the cord.
- Cleaning. Turn your monitor off and unplug the power cord. Clean the monitor surface with a lint-free, non-abrasive cloth. Stubborn stains may be removed with a cloth dampened with mild cleaner.
- Avoid using a cleaner containing alcohol or acetone. Use a cleaner intended for use with the LCD. Never spray cleaner directly on the screen, as it may drip inside the monitor and cause an electric shock.

### The following symptoms are normal with the monitor:

- The screen may flicker during the initial use due to the nature of the fluorescent light. Turn off the Power Switch and turn it on again to make sure that the flicker disappears.
- You may find slightly uneven brightness on the screen depending on the desktop pattern you use.
- When the same image is displayed for hours, an afterimage of the previous screen may remain after switching the image. The screen will recover slowly or you can turn off the Power Switch for hours.
- When the screen becomes black or flashes, or cannot work anymore, contact your dealer or service center to fix it. Do not repair the screen by yourself!

### Conventions used in this guide



**WARNING:** Information to prevent injury to yourself when trying to complete a task.



**CAUTION:** Information to prevent damage to the components when trying to complete a task.



**IMPORTANT:** Information that you **MUST** follow to complete a task.



**NOTE:** Tips and additional information to aid in completing a task.

## Where to find more information

Refer to the following sources for additional information and for product and software updates.

### 1. ASUS websites

The ASUS websites worldwide provide updated information on ASUS hardware and software products. Refer to **<http://www.asus.com>**

### 2. Optional documentation

Your product package may include optional documentation that may have been added by your dealer. These documents are not part of the standard package.

## Takeback Services

ASUS recycling and takeback programs come from our commitment to the highest standards for protecting our environment. We believe in providing solutions for our customers to be able to responsibly recycle our products, batteries and other components as well as the packaging materials.

Please go to <http://csr.asus.com/english/Takeback.htm> for detail recycling information in different region.

## 1.1 Welcome!

Thank you for purchasing the ASUS® LCD monitor!

The latest widescreen LCD monitor from ASUS provides a crisper, broader, and brighter display, plus a host of features that enhance your viewing experience.

With these features, you can enjoy the convenience and delightful visual experience that the monitor brings you!

## 1.2 Package contents

Check your package for the following items:

- ✓ LCD Monitor
- ✓ Monitor Base
- ✓ Quick Start Guide
- ✓ Warranty Card
- ✓ 1x Power Cord
- ✓ 1x Power adapter
- ✓ 1x HDMI Cable (optional)
- ✓ 1x DisplayPort Cable (optional)



- 
- If any of the above items is damaged or missing, contact your retailer immediately.
-

# 1.3 Assembling the monitor

## To assemble the monitor:

1. Place the display flat on a cloth on the table, Then attach the base to the arm and fix with the screw to join them tightly. You can easily tighten the screw by fingers.
2. Adjust the monitor to the angle that is most comfortable for you.

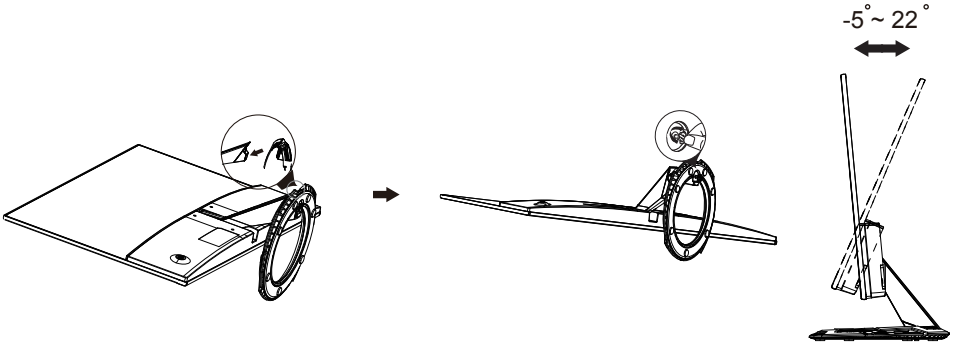

# 1.4 Outline dimension

Unit: mm [inch]

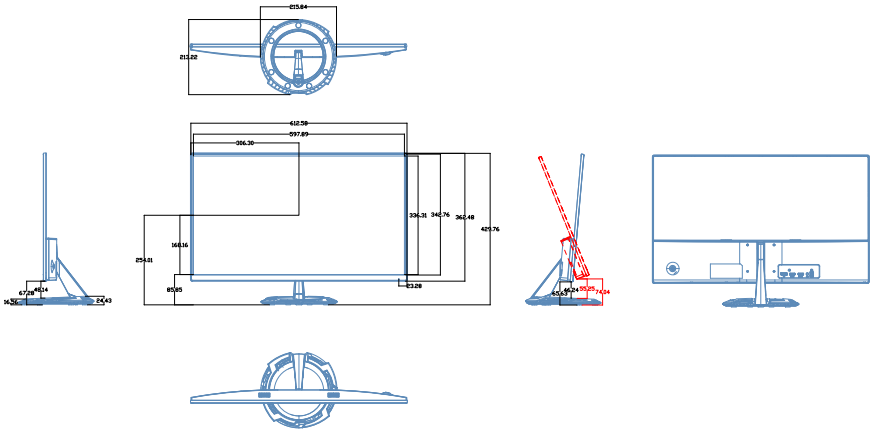



## 1.5 Connect cables

### 1.5.1 Rear of the LCD monitor

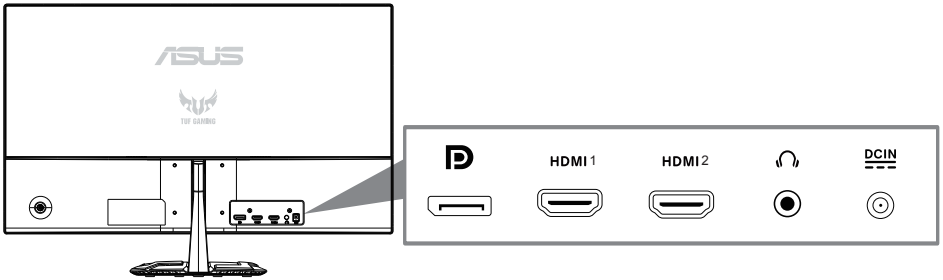

1. DC-IN Port
2. Audio - out Port
3. HDMI 2 Port
4. HDMI 1 Port
5. DisplayPort Port

## 1.6 Monitor introduction

### 1.6.1 Using the Controls button

Use the control button on the back of the monitor to adjust the image settings.

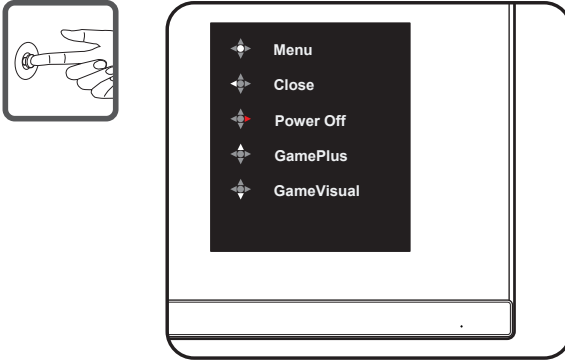

1. Power Indicator:

- The color definition of the power indicator is as the below table.

Status	Description
White	ON
Amber	Standby mode
OFF	OFF

2. Central button:

- Press this button to enter the OSD menu.
- Press this button to turn on the monitor when turned off.

3. Left key:

- Exit the OSD menu or return to the previous layer.

4. Right key:

- Power Off shortcut key.
- Enter the option of the next layer.

5. Up key:

- Use this hotkey to GamePlus.
- Move the option upwards or increase the option value.

6. Down key:

- Use this hotkey to GameVisual.
- Move the option downwards or decrease the option value.
- Key Lock shortcut key. Press and hold it for 5 seconds to enable/disable Keys Lock.

## GamePlus Function

- Press **GamePlus** Button to enter the GamePlus main menu.
- Activate Crosshair, Timer or FPS Counter or Display Alignment function.
- Press the ▼ and ▲ buttons to select and press ● to confirm the function needed. Press ◀ to go off, and exit.

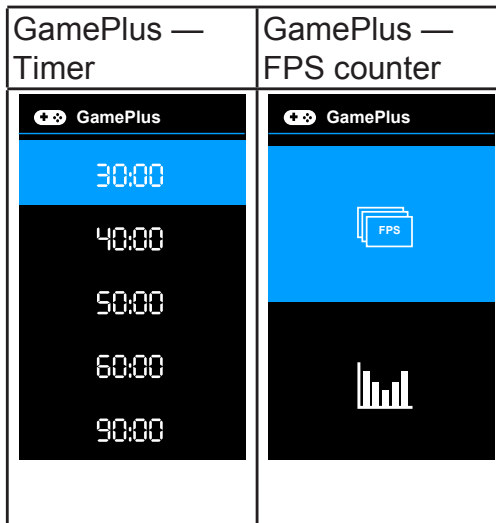

## GameVisual Function

The GameVisual function helps you select among different picture modes in a convenient way.

To active GameVisual:

Press the GameVisual hotkey repeatedly to select.

- **Scenery Mode:** This is the best choice for scenery photo displaying with GameVisual™ Video intelligence Technology.
- **Racing Mode:** This is the best choice for racing game playing with GameVisual™ Video intelligence Technology.
- **Cinema Mode:** This is the best choice for movie watching with GameVisual™ Video intelligence Technology.
- **RTS/RPG Mode:** This is the best choice for Real-Time Strategy (RTS)/ Role-Playing Game (RPG) playing with GameVisual™ Video intelligence Technology.
- **FPS Mode:** This is the best choice for First Person Shooter game playing with GameVisual™ Video intelligence Technology.
- **sRGB Mode:** This is the best choice for viewing photos and graphics from PCs.
- **MOBA Mode:** This is the best choice for multiplayer online battle arena game playing with GameVisual™ Video intelligence Technology.



- 
- In the Racing mode, the following function(s) are not user-configurable: Saturation, Skin Tone, ASCR.
  - In the sRGB mode, the following function(s) are not user-configurable: Brightness, Contrast, Saturation, Color Temp., Skin Tone, ASCR.
  - In the MOBA mode, the following function(s) are not user-configurable: Saturation, Skin Tone, ASCR.
-

## 2.1 Detaching the arm/stand (for wall mount) (wall mount only for HDMI Port)

The detachable stand of this monitor is specially designed for wall mount.

### To detach the arm/stand

1. Disconnect power and signal cables. Carefully put the front of the monitor face down on a clean table.
2. Use a screwdriver to remove the two screws on the arm (Figure 1), and then detach the arm/stand from the monitor (Figure 2).



- We recommend that you cover the table surface with soft cloth to prevent damage to the monitor.
- Hold the stand of the monitor while removing the screws.

Figure 1

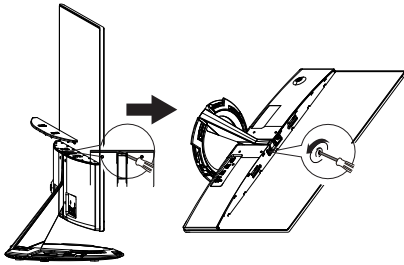
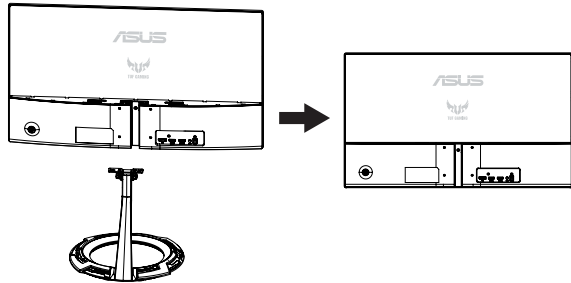

Figure 2



- The wall mount kit (75 x 75 mm) is purchased separately.
- Use only the UL Listed Wall Mount Bracket with minimum weight/load 12 kg (Screw size: M4 x 10 mm).

## 2.2 Adjusting the monitor

- For optimal viewing, we recommend that you look at the full face of the monitor, then adjust the monitor to the angle that is most comfortable for you.
- Hold the stand to prevent the monitor from falling when you change its angle.
- You can adjust the monitor's angle from  $+22^\circ$  to  $-5^\circ$  .

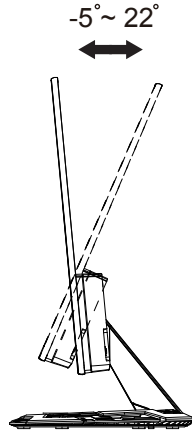

---

It is normal that the monitor slightly shakes while you adjust the viewing angle.

---

## 3.1 OSD (On-Screen Display) menu

### 3.1.1 How to reconfigur

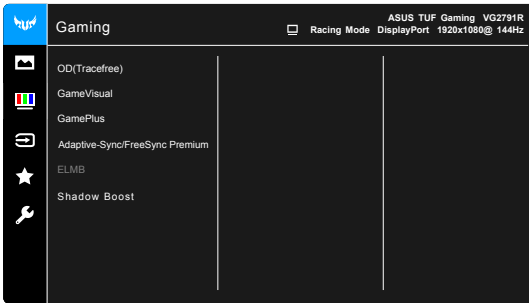

1. Press the MENU button to activate the OSD menu.
2. Press the ▼ and ▲ buttons to toggle between options in the Menu. As you move from one icon to another, the option name is highlighted.
3. To select the highlighted item on the menu press the ● button.
4. Press the ▼ and ▲ buttons to select the desired parameter.
5. Press the ● button to enter the slide bar and then use the ▼ or ▲ buttons, according to the indicators on the menu, to make your changes.
6. Select the ◀ to return to previous menu or ● to accept and return to previous menu.

## 3.1.2 OSD Function Introduction

### 1. Gaming

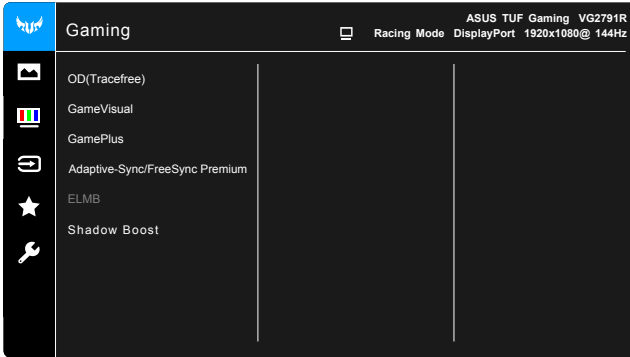

- **OD(Tracefree):** Improves the gray level response time of the LCD panel.



This function is not available when **ELMB** is enabled.

- **GameVisual:** See **1.6.1 GameVisual.Function** for details.
- **GamePlus:** See **1.6.1 GamePlus.Function** for details.
- **Adaptive-Sync/FreeSync Premium:** Allows an FreeSync Premium (Adaptive-Sync) supported graphics source to dynamically adjust display refresh rate based on typical content frame rates for power efficient, virtually stutter free and low-latency display update.



- **Adaptive-Sync/FreeSync Premium** can only be activated within 48Hz~144Hz for DisplayPort.
- **FreeSync Premium** can only be activated within 48Hz~144Hz for HDMI .

- For supported GPUs, minimum PC system and driver requirements, please contact the GPU manufactures.

- **ELMB :** Allows you to turn on the function when FreeSync Premium is Off. This function eliminates screen tearing, reduces ghosting and motion blur when playing games.



When **FreeSync Premium** is Off, this function can only be activated when the refresh rate is 100Hz, 120Hz, or 144Hz.

- **Shadow Boost:** Dark color enhancement adjusts monitor gamma curve to enrich the dark tones in an image, making dark scenes and objects much easier to be seen.



This function is only available in Racing mode, RTS/RPG mode, FPS mode, or sRGB mode.



## 2. Image

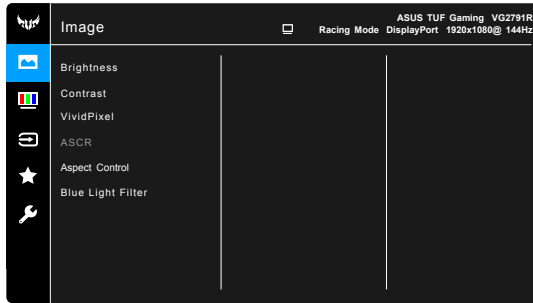

- **Brightness:** The adjusting range is from 0 to 100.
- **Contrast:** The adjusting range is from 0 to 100.

---

- **VividPixel:** Enhances the outline of the displayed picture and generates high-quality images on screen.
- **ASCR:** Turns on/off the ASCR (ASUS Smart Contrast Ratio) function.
- **Aspect Control:** Adjusts the aspect ratio to **Full**, or **4:3**
- **Blue Light Filter**
  - \* **Level 0:** No change.
  - \* **Level 1~4:** The higher the level, the less blue light is scattered. When Blue Light Filter is activated, the default settings of Racing Mode will be automatically imported. Between Level 1 to Level 3, the Brightness function is user-configurable. Level 4 is optimized setting. It is compliance with TUV Low Blue Light Certification. The Brightness function is not user-configurable.



Please refer to the following to alleviate eye strains:

- Users should take some time away from the display if working for long hours. It is advised to take short breaks (at least 5 mins) after around 1 hour of continuous working at the computer. Taking short and frequent breaks is more effective than a single longer break.
- To minimize eye strain and dryness in your eyes, users should rest the eye periodically by focusing on objects that are far away.
- Eye exercises can help to reduce eye strain. Repeat these exercises often. If eye strain continues please consult a physician. Eye exercises: (1) Repeating look up and down (2) Slowly roll your eyes (3) Move your eyes diagonal.
- High energy blue light may lead to eye strain and AMD (Age-Related Macular Degeneration). Blue light Filter to reduce 70% (max.) harmful blue light to avoiding CVS (Computer Vision Syndrome).

### 3. Color

Set a desired color setting from this menu.



- **Color Temp** : Contains 4 modes including Cool, Normal, Warm, and User Mode.
- **Saturation**: the adjusting range is from 0 to 100.
- **Skin Tone**: Contains three color modes including Reddish, Natural, and Yellowish.

### 4. Input Select

In this function, you can select your desired input source.

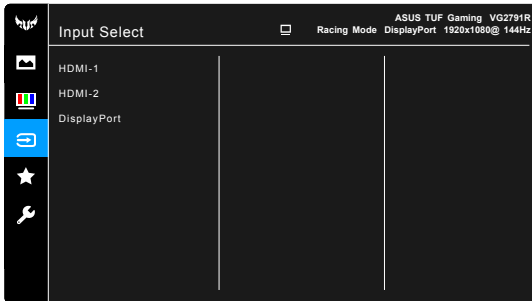

## 5. MyFavorite

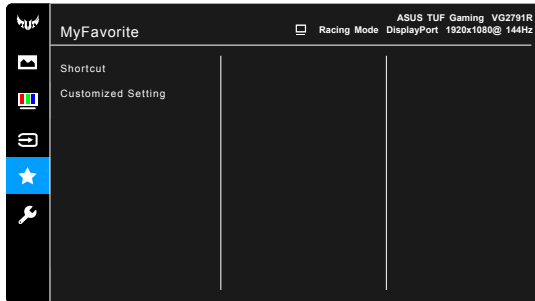

- **Shortcut:**
  - \* **Shortcut 1/Shortcut 2:** Sets the shortcut functions for shortcut buttons.



---

When a certain function is selected or activated, your shortcut button may not support. Available function choices for shortcut: GamePlus (only for **Shortcut 1**), GameVisual (only for **Shortcut 2**), Brightness, Contrast, Blue Light Filter, Color Temp., Volume.

---

- **Customized Setting:** Loads/Saves all settings on the monitor.

## 6. System Setup

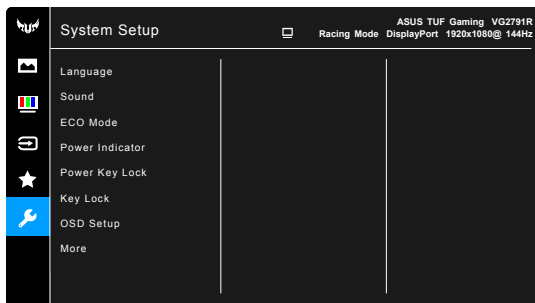

- **Language:** There are 21 languages for your selection, including English, French, German, Italian, Spanish, Dutch, Portuguese, Russian, Czech, Croatian, Polish, Romanian, Hungarian, Turkish, Simplified Chinese, Traditional Chinese, Japanese, Korean, Thai, Indonesian, Persian.
- **Sound:** Sets the sound related settings from this menu.
  - \* **Volume:** The adjusting range is from 0 to 100.
  - \* **Mute:** Toggles the monitor sound between on and off.
- **ECO Mode:** reduces power consumption.
- **Power Indicator:** Turn the power LED indicator on/off.

- **Power Key Lock:** Enables or disables the power key.
- **Key Lock:** To disable all function keys. Press ▼ over 5 seconds to cancel the key lock function.
- **OSD Setup:**
  - \* Adjusts the OSD timeout from 10 to 120 seconds.
  - \* Enables or disables the DDC/CI function.
  - \* Adjusts the OSD background from opaque to transparent.
- **Information:** Shows the monitor information.
- **All Reset:** “Yes” allows you to restore the default settings.

## 3.2 Specification

<b>Model</b>	<b>VG279Q1R</b>
Panel Size	27"W(68.6cm)
Max. Resolution	1920x1080@144Hz
Brightness (Typ.)	250cd/m <sup>2</sup>
Intrinsic Contrast Ratio (Typ.)	1000:1
Viewing Angle (CR>10)	178°(H) /178°(V)
Display Colors	16.7 M
Response Time	4ms (G To G ) 1ms(MPRT)
HDMI unput 1	Yes
HDMI input 2	Yes
DisplayPort	Yes
Audio Line-out	Yes
Power ON Consumption	<18w (Mesasuring a screen brightness of 200 nits Without audio / USB / Card reader connection)
Chassis Colors	Black
Power saving mode	< 0.5W
Power off mode	< 0.3W
Tilt	-5° ~ +22°
Wall Mounting	Yes (75mm x 75mm)
Phys. Dimension with stand (WxHxD)	612.6mm x 431mm x 213mm
Phys. Dimension without stand (WxHxD) (For VESA Wall Mount)	612.6mm x 362.5mm x 37.7mm
Box Dimension (WxHxD)	692mm x 499mm x 183mm
Net Weight (Esti.)	3.6kg
Gross Weight (Esti.)	6.1 kg
Voltage Rating	AC: 100-240V DC: 19V, 2.1A (AC adapter)
Temperature(operation)	0°C~40°C

### 3.3 Troubleshooting (FAQ)

Problem	Possible Solution
Power LED is not ON	<ul style="list-style-type: none"> <li>• Press the  button to check if the monitor is in the ON mode.</li> <li>• Check if the power cord is properly connected to the monitor and the power outlet.</li> <li>• Check Power Indicator function in main menu OSD. Select "ON" to turn on power LED.</li> </ul>
The power LED lights amber and there is no screen image	<ul style="list-style-type: none"> <li>• Check if the monitor and the computer are in the ON mode.</li> <li>• Make sure the signal cable is properly connected the monitor and the computer.</li> <li>• Inspect the signal cable and make sure none of the pins are bent.</li> <li>• Connect the computer with another available monitor to check if the computer is properly working.</li> </ul>
Screen image is too light or dark	<ul style="list-style-type: none"> <li>• Adjust the Contrast and Brightness settings via OSD.</li> </ul>
Screen image bounces or a wave pattern is present in the image	<ul style="list-style-type: none"> <li>• Make sure the signal cable is properly connected to the monitor and the computer.</li> <li>• Move electrical devices that may cause electrical interference.</li> </ul>
Screen image has color defects (white does not look white)	<ul style="list-style-type: none"> <li>• Inspect the signal cable and make sure that none of the pins are bent.</li> <li>• Perform Reset via OSD.</li> <li>• Adjust the R/G/B color settings or select the Color Temperature via OSD.</li> </ul>
No sound or sound is low	<ul style="list-style-type: none"> <li>• Make sure the audio cable is properly connected to the monitor.</li> <li>• Adjust the volume settings of both your monitor and computer.</li> <li>• Make sure the computer sound card driver is properly installed and activated.</li> <li>• Make sure the audio source is correct on the OSD.</li> </ul>

## 3.4 Supported Timing List

### PC Supported Primary Timing

Resolution	Refresh Rate	Horizontal Frequency
640x480	60Hz	31.469kHz
640x480	72Hz	37.861kHz
640x480	75Hz	37.5kHz
800x600	56Hz	35.156kHz
800x600	60Hz	37.879kHz
800x600	72Hz	48.077kHz
800x600	75Hz	46.875kHz
1024x768	60Hz	48.363kHz
1024x768	70Hz	56.476kHz
1024x768	75Hz	60.023kHz
1152x864	75Hz	67.5kHz
1280x960	60Hz	60kHz
1280x1024	60Hz	63.981kHz
1280x1024	75Hz	79.976kHz
1440x900	60Hz	55.935kHz
1440x900	75Hz	70.635kHz
1680x1050	60Hz	65.29kHz
1920x1080	60Hz	67.5kHz
1280x720	60Hz	44.772kHz
1920x1080	100Hz	137.3kHz
1920x1080	120Hz	139.1kHz
1920x1080	144Hz	158.1kHz

#### IBM Modes, Factory Preset Timing

Resolution	Refresh Rate	Horizontal Frequency
640x350	70Hz	31.469kHz
720x400	70Hz	31.469kHz

#### MAC Modes, Factory Preset Timing

Resolution	Refresh Rate	Horizontal Frequency
640x480	67Hz	35kHz
832x624	75Hz	49.725kHz

#### VESA Modes, User Available Timing

Resolution	Refresh Rate	Horizontal Frequency
848x480	60Hz	31.02kHz
1280x720(RB)	60Hz	44.444kHz
1280x720	60Hz	44.772kHz
1280x720	75Hz	56.456kHz
1280x768(RB)	60Hz	47.396kHz
1280x800(RB)	60Hz	49.306kHz
1280x800	60Hz	49.702kHz
1280x800	75Hz	62.795kHz
1366x768	60Hz	47.712kHz

1440x900(RB)	60Hz	55.469kHz
1440x900	75Hz	70.635kHz
1680x1050(RB)	60Hz	64.674kHz
1920x1080	60Hz	66.587kHz

## SD/HD Timings

HDMI/DP,CEA-861B Formats, SD/HD Supported Primary Timings of

Resolution	Refresh Rate	Horizontal Frequency
640 x 480 P 4:3	59.94/60Hz	31.469kHz
720 x 480 P 4:3	59.94/60Hz	31.469/31.5kHz
720 x 480 P 16:9	59.94/60Hz	31.469 / 31.5kHz
720 x 576 P 4:3	50Hz	31.25kHz
720 x 576 P 16:9	50Hz	31.25kHz
1280 x 720 P 16:9	50Hz	37.5kHz
1280 x 720 P 16:9	59.94/60Hz	44.955/45kHz
1440 x 480 P 4:3	59.94/60Hz	31.469/ 31.5kHz
1440 x 480 P 16:9	59.94/60Hz	31.469/ 31.5kHz
1440 x 576 P 4:3	50Hz	31.25kHz
1440 x 576 P 16:9	50Hz	31.25kHz
1920 x 1080 P 16:9	50Hz	56.25kHz
1920 x 1080 P 16:9	59.94/60Hz	67.433/67.5kHz

HDMI/DP,CEA-861B Formats, SD/HD Supported Optional Timings of

Resolution	Refresh Rate	Horizontal Frequency
1440x480P	59.94 / 60Hz	31.469 / 31.5kHz
1440x576P	50Hz	31.25kHz
1920x1080P	50Hz	56.25kHz
1920x1080P	59.94 / 60Hz	67.433 / 67.5kHz

\* The modes not listed in the above tables may not be supported. For optimal resolution, we recommend that you choose a mode listed in the above tables.