



RAZER THUNDERBOLT™ 4 DOCK CHROMA

MASTER GUIDE

CONTENTS

1. WHAT'S INSIDE / WHAT'S NEEDED.....	2
2. WHAT'S NEEDED	3
3. LET'S GET YOU COVERED.....	3
4. SETTING UP YOUR RAZER THUNDERBOLT™ 4 DOCK CHROMA.....	4
5. CONFIGURING YOUR RAZER THUNDERBOLT™ 4 DOCK CHROMA.....	5
6. SAFETY AND MAINTENANCE	12
7. LEGALESE.....	13

1. WHAT'S INSIDE / WHAT'S NEEDED

- Razer Thunderbolt™ 4 Dock Chroma

Model No.: RC21-0169

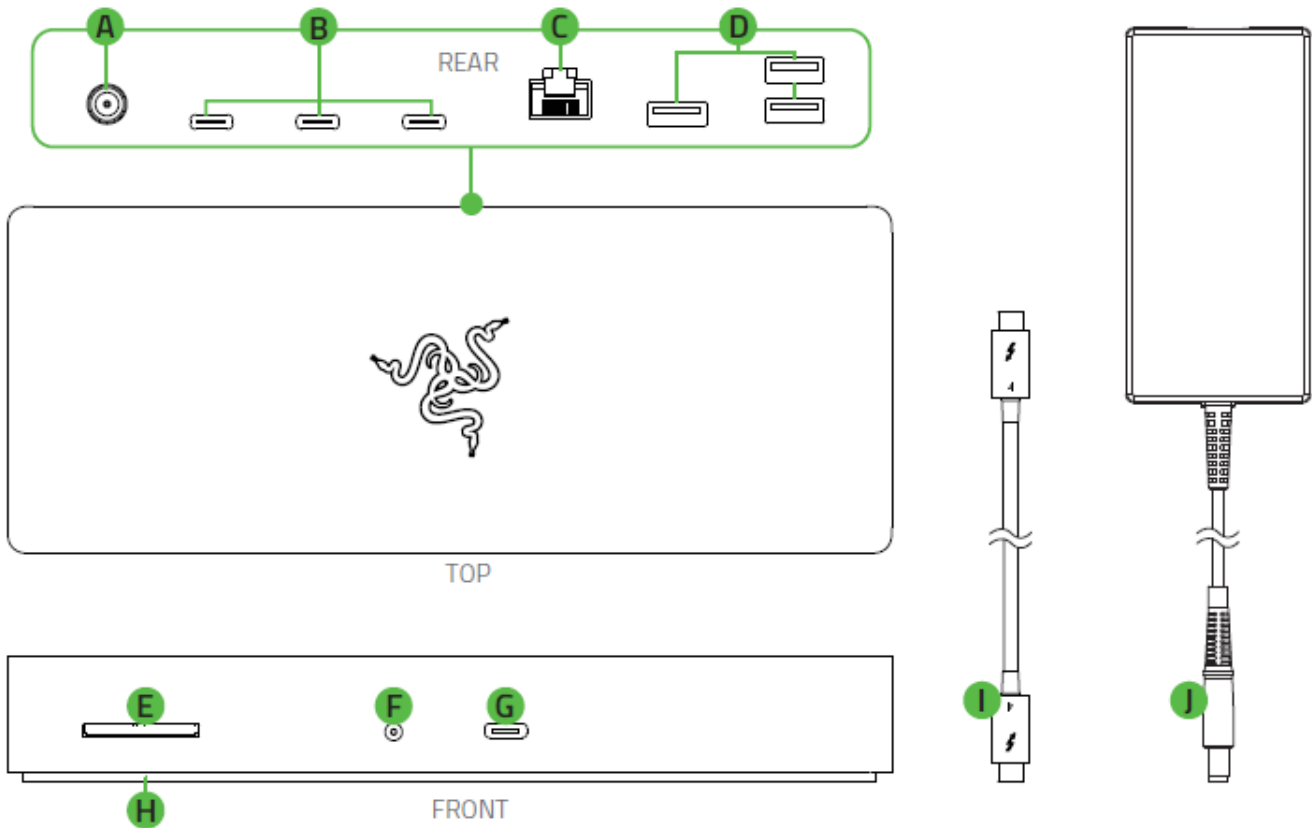

- A.** Power port
- B.** Thunderbolt™ 4 / USB Type-C ports (receiver)
- C.** Gigabit Ethernet port (RJ-45)
- D.** USB 3.1 Gen 2 Type-A ports
- E.** SD card slot
- F.** 3.5mm audio combo port
- G.** Thunderbolt™ 4 / USB Type-C port (source)
- H.** Razer Chroma™ RGB underglow lighting
- I.** 100W Thunderbolt™ 4 / USB Type-C cable
- J.** Power adapter + regional power cord

- Important Product Information Guide

2. WHAT'S NEEDED

PRODUCT REQUIREMENTS

- PC with a free Thunderbolt™ 4 / USB Type-C port or compatible Thunderbolt™ 3 devices*
- AC power outlet

RAZER SYNAPSE REQUIREMENTS

- Windows® 10 64-bit (or higher)
- Internet connection for software installation

*Compatible Thunderbolt™ 3 devices listed here: rZR.to/ZIUhg

3. LET'S GET YOU COVERED

You've got a great device in your hands, complete with a 1-year limited warranty coverage. Now maximize its potential and score exclusive Razer benefits by registering at razerid.razer.com

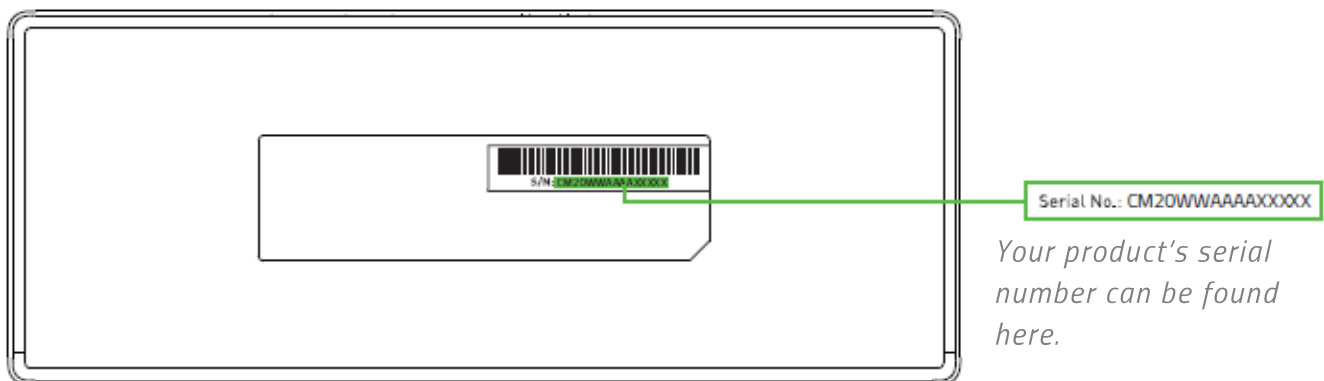

Got a question? Ask the Razer Support Team at support.razer.com

4. SETTING UP YOUR RAZER THUNDERBOLT™ 4 DOCK CHROMA

1. With the appropriate power cord connected to the power adapter, insert its AC plug into a power outlet, and then connect it to the power port of your Razer Thunderbolt™ 4 Dock Chroma.

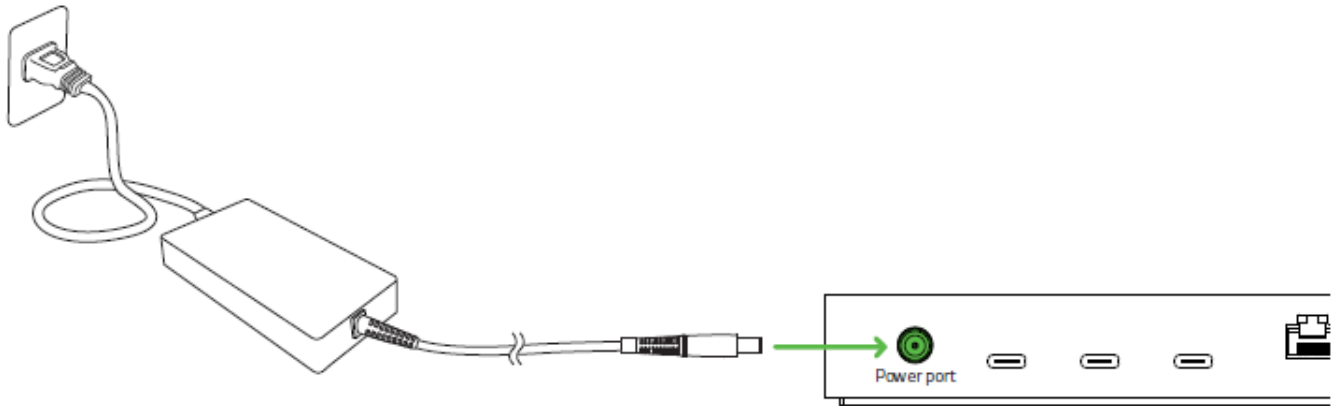

2. Using the provided cable, connect your Razer device to the Thunderbolt™ 4/USB Type-C port (source) of your computer.

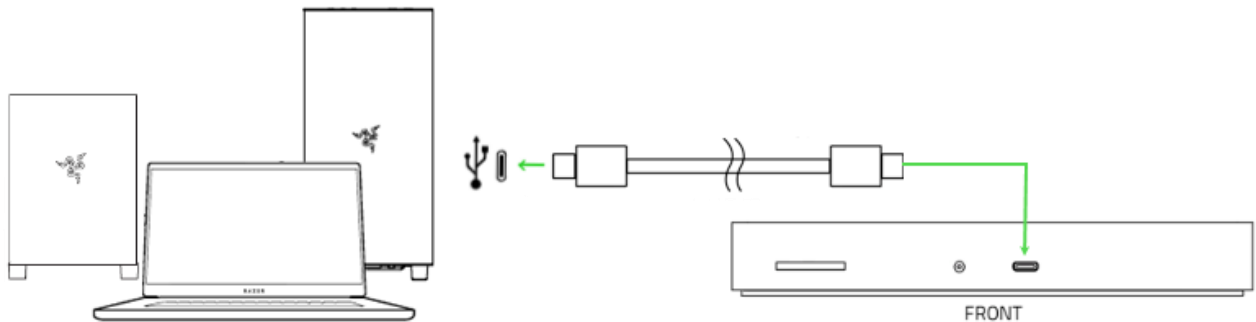

i Thunderbolt™ 4 supports up to USB 4 and is compatible with previous versions.

3. Use the Razer Synapse app to customize your device's lighting.

i Install Razer Synapse when prompted or download the installer from razer.com/synapse.

5. CONFIGURING YOUR RAZER THUNDERBOLT™ 4 DOCK CHROMA

Disclaimer: The features listed here require you to log in to Razer Synapse. These features are also subject to change based on the current software version and your Operating System.

SYNAPSE TAB

The Synapse tab is your default tab when you first launch Razer Synapse 3. This tab allows you to navigate the Dashboard subtab.

Dashboard

The Dashboard subtab is an overview of your Razer Synapse 3 where you can access all your Razer devices, modules, and online services.

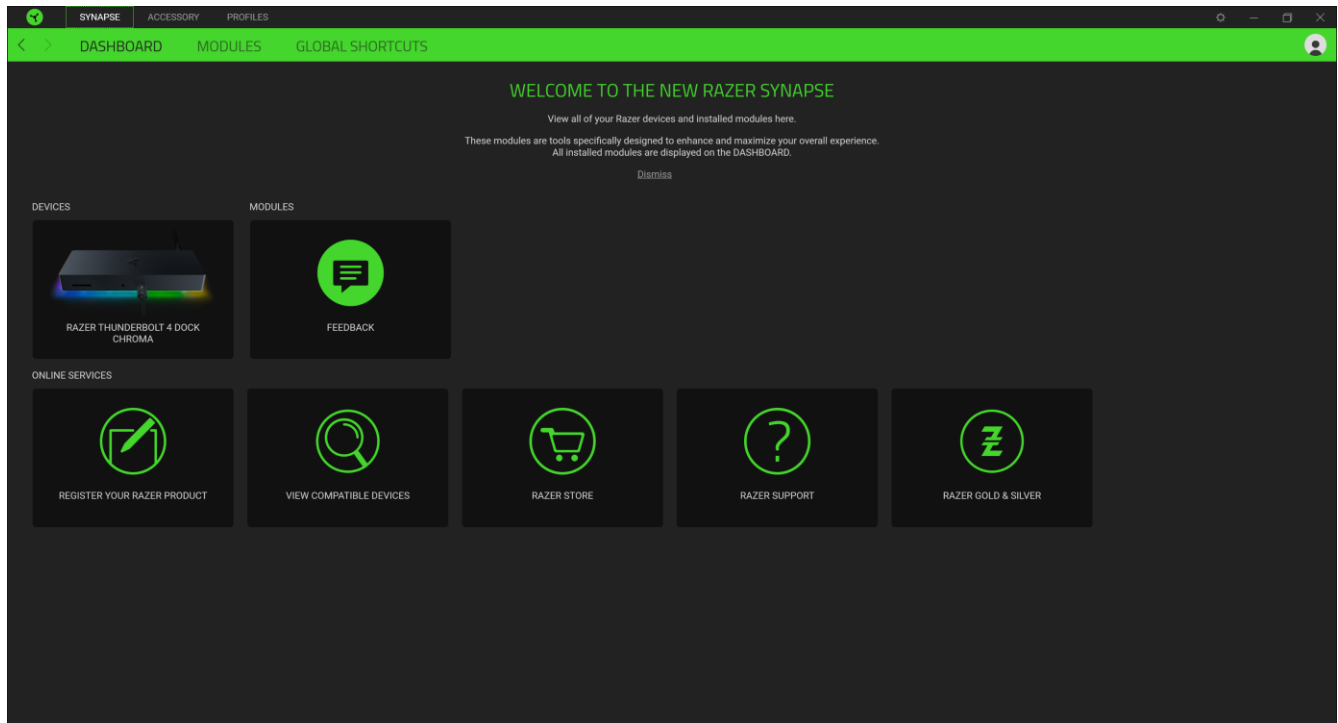

ACCESSORY TAB

The Accessory tab is the main tab for your Razer Thunderbolt™ 4 Dock Chroma. From here, you can customize your device's settings to unleash its full potential. Changes made under this tab are automatically saved to your system and cloud storage.

AUDIO

The Audio subtab is for modifying your device's sound properties.

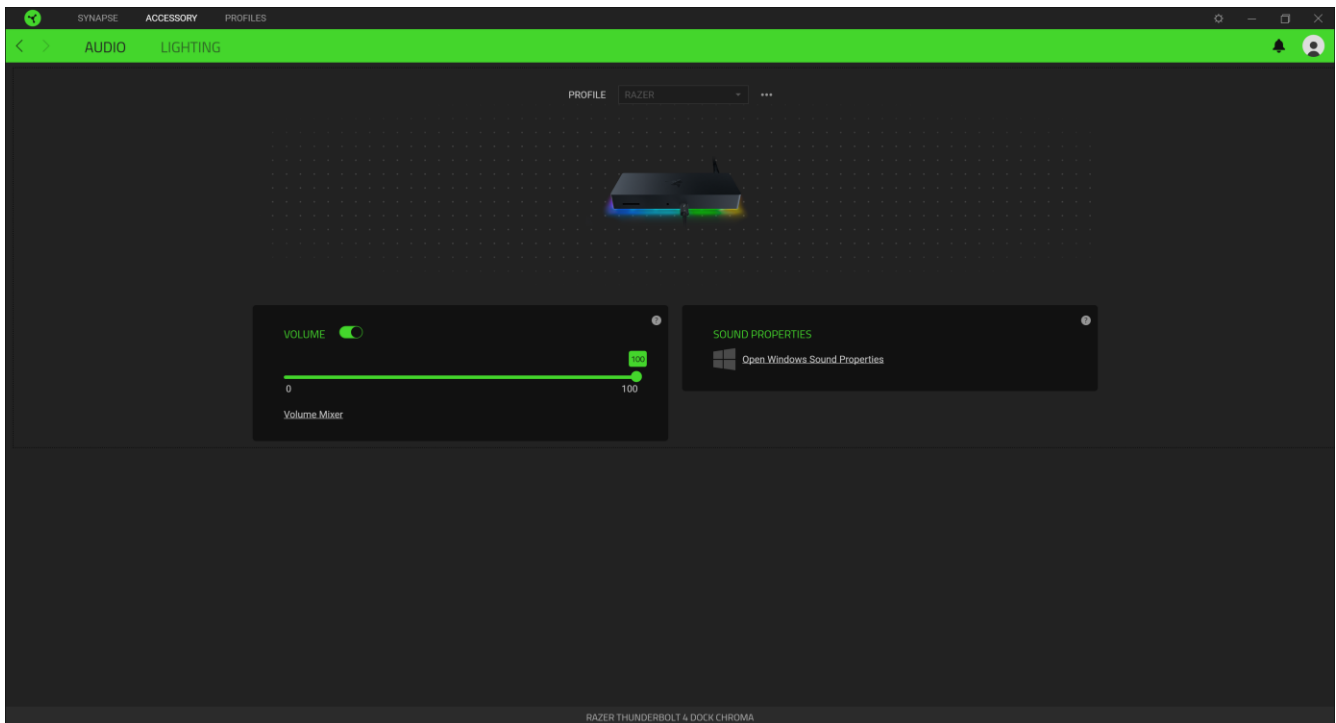

Lighting

The Lighting subtab enables you to modify your Razer device's light settings.

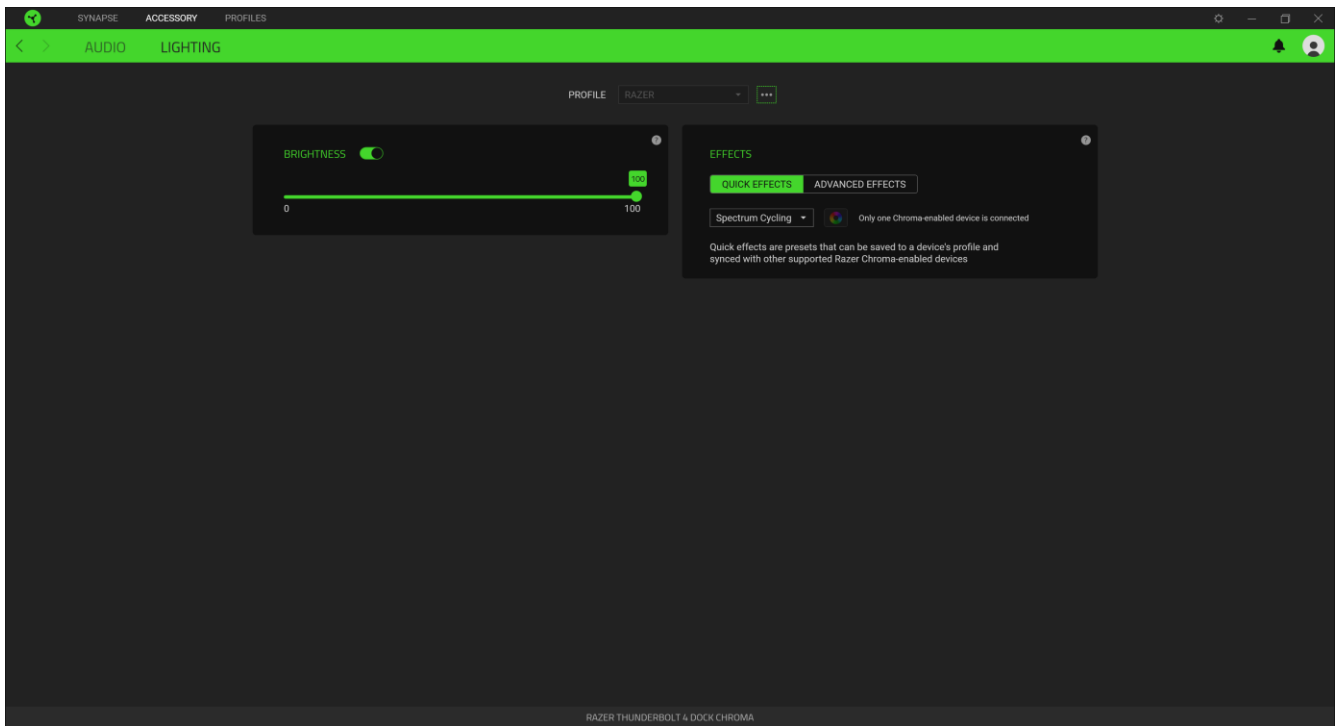

Brightness

You can turn off your Razer device's lighting by toggling the Brightness option or increase/decrease the luminance using the slider.







Switch Off Lighting

This is a power saving tool which allows you to disable your device's lighting in response to your system's display turning off.

Quick Effects

A number of quick effects can be selected and applied to your mouse's lighting, as listed here:

	Name	Description	How to set up
	Audio meter	The device will light up according to the audio level with a default spectrum of colors	Select a Color Boost level

	Breathing	The lighting fades in and out of the selected color(s)	Select up to 2 colors or randomize
	Fire	The device lights up in warm colors to mimic the motion of flames	No further customization required
	Spectrum cycling	The LEDs will cycle between 16.8 million colors indefinitely	No further customization required
	Starlight	Each LED will fade in and out at a random time and duration	Select up to 2 colors or randomize colors and select a duration
	Static	The LEDs will remain lit in the selected color	Select a color
	Wave	The lighting will move in the direction selected with a default spectrum of colors	Select either clockwise or counterclockwise wave direction

If you have other supported Razer Chroma-enabled devices, you can synchronize their quick effects with your Razer device by clicking the Chroma Sync button ().

Advanced Effects

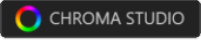
The Advanced Effects option allows you to choose a Chroma Effect you want to use on your Razer Chroma-enabled peripheral. To start making your own Chroma Effect, simply press the Chroma Studio button (). [Click here to learn more about the Chroma Studio](#)



PROFILES TAB

The Profiles tab is a convenient way of managing all your profiles and linking them to your games and applications.

Devices

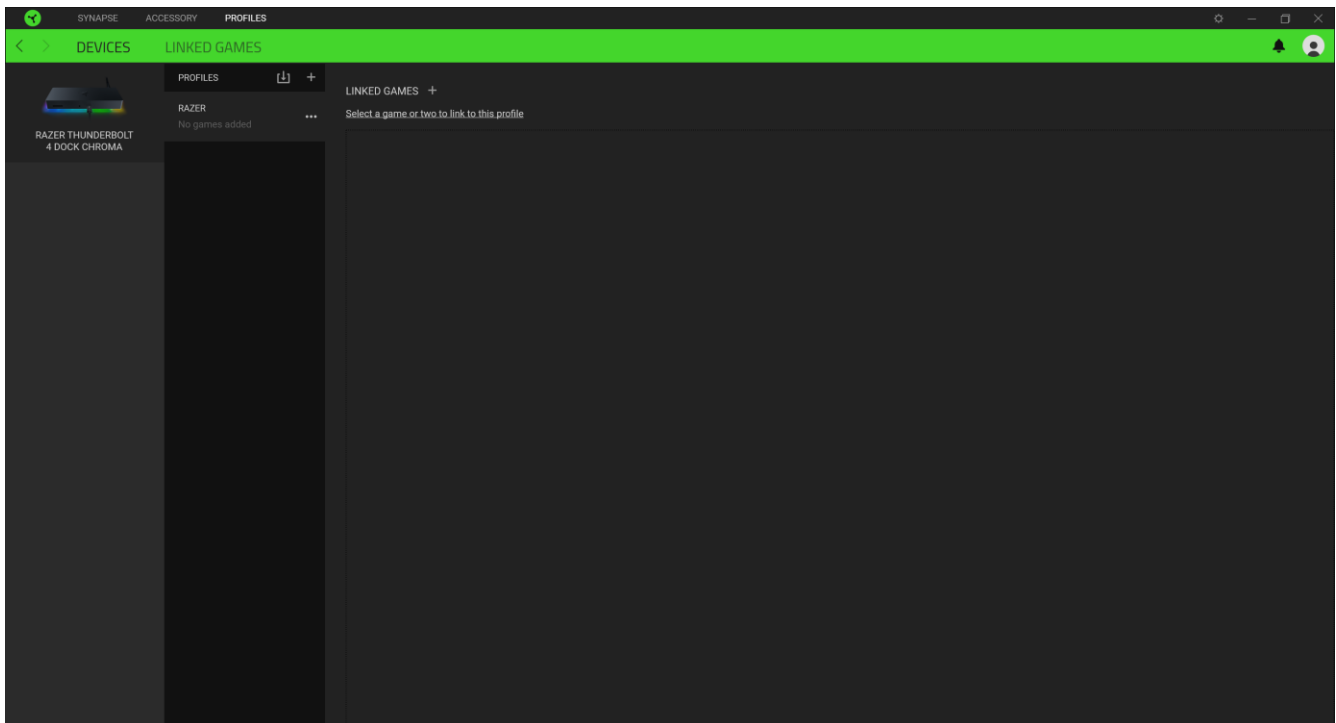
View which games are linked to each device's profiles or which Chroma Effect is linked to specific games using the Devices subtab.



You can import Profiles / Chroma Effects from your computer or from the cloud through the import button (), or create new profiles within the selected device or new Chroma Effects for specific games using the add button (). To rename, duplicate, export, or delete a profile, simply press the Miscellaneous button (). Each profile and/or Chroma Effect can be set to automatically activate when you run an application using the Linked Games option.

Linked Games

The Linked Games subtab gives you the flexibility to add games, view peripherals that are linked to games, or search for added games. You can also sort games based on alphabetical order, last played, or most played. Added games will still be listed here even if it is not linked to a Razer device.

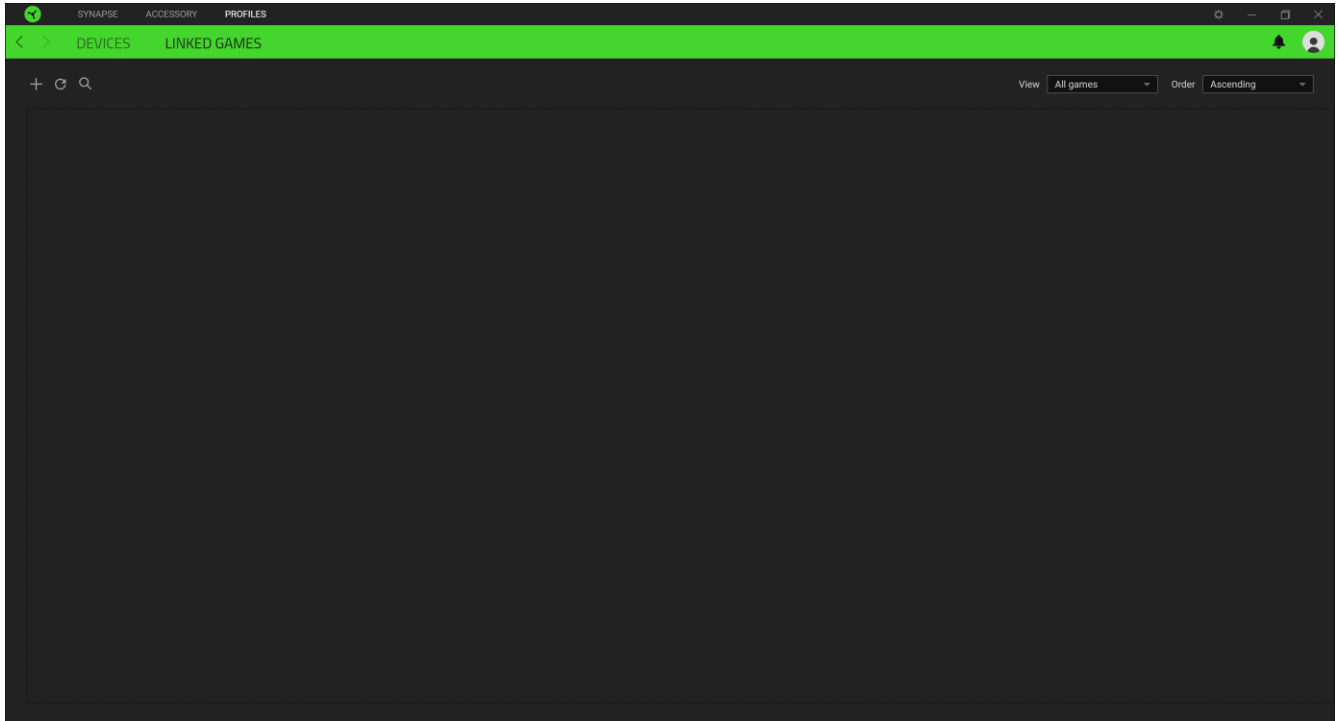

To link games to connected Razer devices or Chroma Effects, simply click on any game from the list, and then click **Select a device and its profile to launch automatically during gameplay** to select the Razer device or Chroma Effect it will link with.

Once linked, you may click on the Miscellaneous button (●●●) of the corresponding Chroma Effect or device to select a specific Chroma Effect or profile.

SETTINGS WINDOW

The Settings window, accessible by clicking the () button on Razer Synapse 3, enables you to configure the startup behavior, change language, view your Razer device's master guide, or perform factory reset on any connected Razer device.

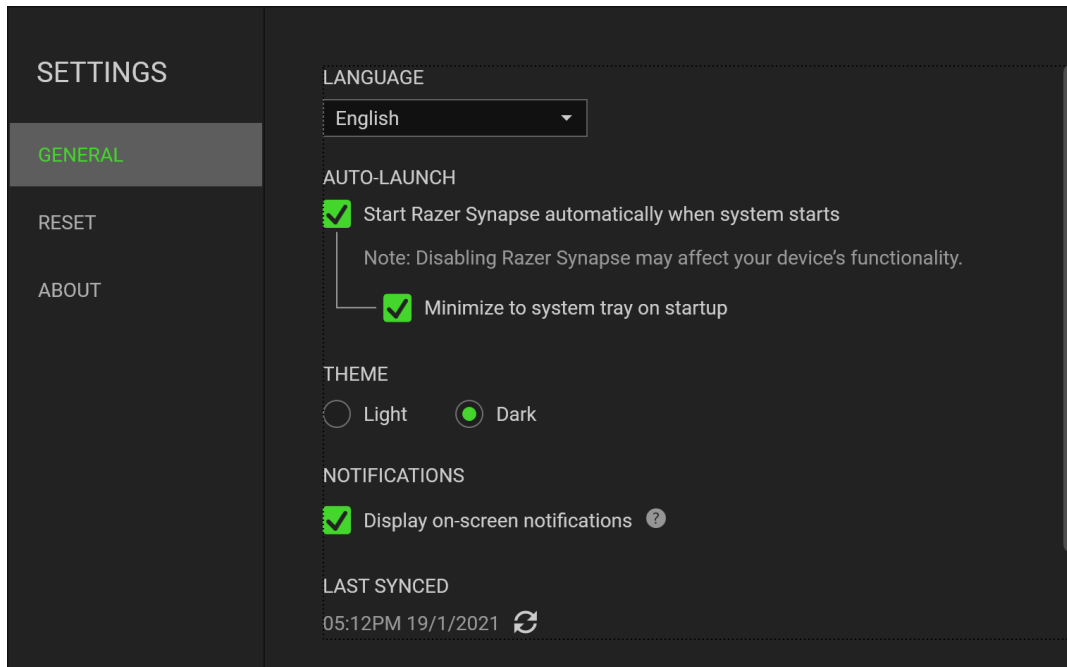

General tab

The default tab of the Settings window. The General tab enables you to change the software's display language, start-up behavior, and display theme; or view the master guide of all connected Razer devices. You may also manually sync your profiles to the cloud () or view the master guide of all connected Razer devices.

Reset tab

The Reset tab allows you to perform a factory reset on all connected Razer devices with on-board memory and/or reset Razer Synapse 3 tutorials to acquaint yourself again with Razer Synapse 3's new features on its next launch.

 *By resetting a Razer device, all profiles stored on the selected device's on-board memory will be erased.*

About tab

The About tab displays brief software information, copyright statement, and provides relevant links for its terms of use. You may also use this tab to check for software updates, or as a quick access to Razer's social communities.

6. SAFETY AND MAINTENANCE

SAFETY GUIDELINES

In order to achieve maximum safety while using your Razer Thunderbolt™ 4 Dock Chroma, we suggest that you adopt the following guidelines:

Should you have trouble operating the device properly and troubleshooting does not work, unplug the device and contact the Razer hotline or go to support.razer.com for support.

Do not take apart the device (doing so will void your warranty) and do not attempt to operate it under abnormal current loads.

Keep the device away from liquid, humidity or moisture. Operate the device only within the specific temperature range of 0°C (32°F) to 40°C (104°F). Should the temperature exceed this range, unplug and/or switch off the device in order to let the temperature stabilize to an optimal level.

MAINTENANCE AND USE

The Razer Thunderbolt™ 4 Dock Chroma requires minimum maintenance to keep it in optimum condition. Once a month we recommend you unplug the device from the computer and clean it using a soft cloth or cotton swab with a bit of warm water to prevent dirt buildup. Do not use soap or harsh cleaning agents.

7. LEGALESE

COPYRIGHT AND INTELLECTUAL PROPERTY INFORMATION

©2021 Razer Inc. All rights reserved. Razer, the triple-headed snake logo, Razer logo, “For Gamers. By Gamers.”, and “Powered by Razer Chroma” logo are trademarks or registered trademarks of Razer Inc. and/or affiliated companies in the United States or other countries. All other trademarks and trade names are the property of their respective owners and other company and product names mentioned herein may be trademarks of their respective companies.

Windows and the Windows logo are trademarks or registered trademarks of the Microsoft group of companies.

Thunderbolt and the Thunderbolt logo are trademarks of Intel Corporation in the U.S. and/or other countries.

Razer Inc. (“Razer”) may have copyright, trademarks, trade secrets, patents, patent applications, or other intellectual property rights (whether registered or unregistered) concerning the product in this guide. Furnishing of this guide does not give you a license to any such copyright, trademark, patent or other intellectual property right. The Razer Thunderbolt™ 4 Dock Chroma (the “Product”) may differ from pictures whether on packaging or otherwise. Razer assumes no responsibility for such differences or for any errors that may appear. Information contained herein is subject to change without notice.

LIMITED PRODUCT WARRANTY

For the latest and current terms of the Limited Product Warranty, please visit [razer.com/warranty](https://www.razer.com/warranty).

LIMITATION OF LIABILITY

Razer shall in no event be liable for any lost profits, loss of information or data, special, incidental, indirect, punitive or consequential or incidental damages, arising in any way out of distribution of, sale of, resale of, use of, or inability to use the Product. In no event shall Razer’s liability exceed the retail purchase price of the Product.

COSTS OF PROCUREMENT

For the avoidance of doubt, in no event will Razer be liable for any costs of procurement unless it has been advised of the possibility of such damages, and in no case shall Razer be liable for any costs of procurement liability exceeding the retail purchase price of the Product.

GENERAL

These terms shall be governed by and construed under the laws of the jurisdiction in which the Product was purchased. If any term herein is held to be invalid or unenforceable, then such term (in so far as it is invalid or unenforceable) shall be given no effect and deemed to be excluded without invalidating any of the remaining terms. Razer reserves the right to amend any term at any time without notice.