

fx-83GT CW
fx-85GT CW
User's Guide

CASIO Worldwide Education Website

<https://edu.casio.com>

Manuals are available in multi languages at

<https://world.casio.com/manual/calc/>

Table of Contents

Before Using the Calculator	5
Read This First	5
About This Manual	5
Key Operations	5
Menu Operations	6
Ⓚ Key and ⓧ Key	7
Examples	7
Initializing the Calculator	7
Calculator "Get Started" Screen	7
Precautions	8
Safety Precautions	8
Handling Precautions	10
Getting Started	10
Attaching and Removing the Front Cover	10
Turning Power On and Off	12
HOME Screen	13
Adjusting Display Contrast	13
Key Markings	13
Indicators	14
Using Menus	14
Calculator Apps and Menus	17
Calculator Apps	17
Selecting a Calculator App	17
Installed Calculator App List	17
Using the SETTINGS Menu	18
Changing Calculator Settings	19
Items and Available Setting Options	19
Using the CATALOG Menu	23
Using the TOOLS Menu	24
Inputting Expressions and Values	25
Basic Input Rules	25
Inputting an Expression Using Natural Textbook Format (MathI/MathO or MathI/DecimalO Only)	26
Undo Operations	27
Using Values and Expressions as Arguments	27
Overwrite Input Mode (LineI/LineO or LineI/DecimalO Only)	27
Basic Calculations	28
Arithmetic Calculations	28
Fraction Calculations	28
Powers, Power Roots, and Reciprocals	30

Pi, Natural Logarithm Base e	32
Pi	32
Natural Logarithm Base e	32
Calculation History and Replay	32
Calculation History	32
Replay	33
Using Memory Functions	33
Answer Memory (Ans)	33
Variables (A, B, C, D, E, F, x, y, z)	34
Clearing the Contents of All Memories	36
Changing Calculation Result Format	37
Using the FORMAT Menu	37
FORMAT Menu List	37
Conversion Sample Operation	38
Standard and Decimal Conversion	38
Prime Factorization	39
Recurring Decimal Conversion (Recurring Decimal Calculations)	40
Converting a Calculation Result to a Recurring Decimal Value	40
Inputting a Recurring Decimal	40
Recurring Decimal Calculation Example	41
Improper Fraction and Mixed Fraction Conversion	42
Engineering Notation	42
Sexagesimal Conversion (Degree, Minute, Second Calculations)	43
Converting a Decimal Value Calculation Result to a Sexagesimal Value	43
Inputting and Calculating with a Sexagesimal Value	44
Advanced Calculations	45
Function Analysis	45
Logarithm(logab), Logarithm(log)	45
Natural Logarithm	46
Probability	46
%	46
Factorial(!)	47
Permutation(P), Combination(C)	47
Random Number	47
Random Integer	47
Numeric Calculations	48
GCD, LCM	48
Absolute Value	48
Recurring Decimal	49
Round Off	49
Angle Unit, Polar/Rectangular Coordinate, Sexagesimal	49
Degrees, Radians, Gradians	49
Rect to Polar, Polar to Rect	50
Degrees, Minutes, Seconds	50
Hyperbolic, Trigonometric	51

Hyperbolic Functions	51
Trigonometric Functions	51
Others	52
Registering and Using Defining Equations for $f(x)$ and $g(x)$	53
Registering and Using Defining Equations for $f(x)$ and $g(x)$	53
Registering a Defining Equation	53
Performing a Calculation by Assigning a Value to the Registered Defining Equation	54
Registering a Composite Function	54
Data Retention	55
Using QR Code Functions	56
Using QR Code Functions	56
Displaying a QR Code	56
If You Experience Difficulty Scanning a QR Code	57
Using Calculator Apps	58
Statistical Calculations	58
General Procedure for Performing a Statistical Calculation	58
Inputting Data with Statistics Editor	59
Displaying Statistical Calculation Results	62
Using Statistical Calculation Screen	66
Statistical Calculation Formula	71
Creating a Number Table	74
General Procedure for Creating a Number Table	74
Maximum Number of Rows in a Number Table According to Table Type	75
Defining Equation Registration	76
Editing Number Table Screen Data	76
$f(x)$ and $g(x)$ Update Timing	77
Data Retention	77
Ratio Calculations	78
General Procedure for Performing a Ratio Calculation	78
Calculation Example	79
Using Math Box	79
Dice Roll	79
Coin Toss	83
Number Line	86
Circle	90
Technical Information	95
Errors	95
Displaying the Location of an Error	95
Error Messages	95
Before Assuming Malfunction of the Calculator...	97
Replacing the Battery	98
Calculation Priority Sequence	99

Calculation Ranges, Number of Digits, and Precision	100
Calculation Range and Precision	100
Function Calculation Input Ranges and Precision	101
Specifications	103
Frequently Asked Questions	105
Frequently Asked Questions	105

Before Using the Calculator

Read This First

About This Manual

- In no event shall CASIO Computer Co., Ltd. be liable to anyone for special, collateral, incidental, or consequential damages in connection with or arising out of the purchase or use of this product and items that come with it. Moreover, CASIO Computer Co., Ltd. shall not be liable for any claim of any kind whatsoever by any other party arising out of the use of this product and the items that come with it.
- The contents of this manual are subject to change without notice.
- The displays and illustrations (such as key markings) shown in this manual are for illustrative purposes only, and may differ somewhat from the actual items they represent.
- QR Code is a registered trademark of DENSO WAVE INCORPORATED in Japan and in other countries.
- Company and product names used in this manual may be registered trademarks or trademarks of their respective owners.

Key Operations

The example below shows how key operations are represented in this manual.

Example 1: AC $\sqrt{\square}$ 9 EXE

Keys should be pressed in the sequence shown above (left to right).

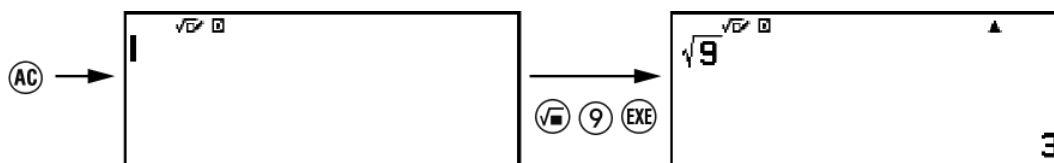

Example 2: \uparrow 7 $(\pi)^*$

The above indicates you should press \uparrow and then 7 , which will input a π symbol. All multiple-key input operations are indicated like this. Key cap markings are shown, followed by the input character or command in parentheses.

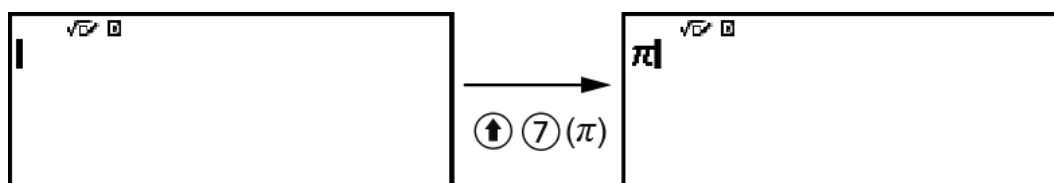

* Refer to **"Key Markings" (page 13)** for more information about the key symbols used in this example.

Example 3: ⤴, ⤵, ⤶, ⤷, ⤴⤵, ⤶⤷

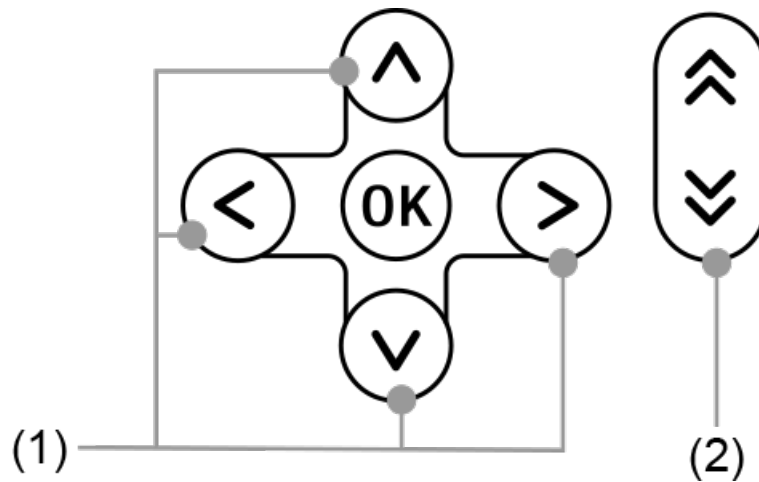

- Individual cursor keys indicated by (1) are represented as ⤴, ⤵, ⤶, ⤷.
- Individual page scroll keys indicated by (2) are represented as ⤴⤵, ⤶⤷.

Menu Operations

Some operations in this manual use a simplified form of menu operations, as shown in the examples below.

Example 1

⊞ – [Other] > [π]

or

Press ⊞, and then select [Other] > [π].



Actual Operation 1

1. Press ⊞.
2. Use ⤴ and ⤵ to select [Other], and then press OK.
3. Use ⤴ and ⤵ to select [π], and then press OK.







Example 2

⊞ - Calculate









or

Press , select the Calculate app icon, and then press .

Actual Operation 2

1. Press .
2. Use the cursor keys (, , , ) to select the Calculate app icon, and then press .

Key and Key

The  key and  key perform the same operation. In this manual,  is used for selecting or applying a setting, while  is used for executing a calculation. Note, however, that it makes no difference whether you press  or  for operations where either  or  is shown.

Examples

If you are not instructed to use a specific calculator app or to configure particular settings for an example operation, the app and settings below are assumed.

Calculator app: Calculate







Settings: Initial default calculator settings

For information about returning the calculator to its initial default settings, see ["Initializing the Calculator" \(page 7\)](#).

Initializing the Calculator

Important!

- The procedure below initializes all calculator settings, except for Contrast and Auto Power Off. Also clears all data stored in calculator memory.

1. Press  to display the HOME screen.
2. Use the cursor keys (, , , ) to select a calculator app icon, and then press .
3. Press , and then select [Reset] > [Initialize All] > [Yes].
 - This displays the HOME screen.

Calculator "Get Started" Screen

While the HOME screen is displayed, pressing the  key will display the "Get Started" screen, which includes the information below.

- QR Code for accessing the "Get Started" webpage of the Worldwide Education Service (<https://wes.casio.com/calc/cw/>)
The Get Started webpage gives you access to the User's Guide and other related information to help you get started with your calculator.
- Calculator ID number (24-character string)

Press  to return to the HOME screen.

Note

- You can also display the Get Started screen, by selecting it from the SETTINGS menu. See "[Using the SETTINGS Menu](#)" (page 18).

Precautions

Safety Precautions

Thank you for purchasing this CASIO product.

Be sure to read the "Safety Precautions" before using this product to ensure that you use it correctly. Be sure to keep all user documentation handy for future reference.

Danger

Indicates something that creates the major risk of death or serious personal injury.

Button Type and Coin Type Battery Precautions (fx-85GT CW only)

 **Take care to ensure that a battery will not be swallowed accidentally.**

 **Particular care is required to keep batteries away from children.**

Should a battery be swallowed accidentally or if there is a possibility that a battery has been swallowed, immediately contact a physician. Swallowing a battery can result in chemical burns, mucosal tissue penetration, and other serious problems that create the risk of death.

Warning

Indicates something that creates the risk of death or serious personal injury.

■ Display Screen

 **Do not press the LCD or subject it to strong impact.**

Doing so can cause the LCD glass to crack, creating the risk of personal injury.

 **Should the LCD become cracked, never touch any of the liquid inside.**

LCD liquid getting on the skin creates the risk of skin irritation.

Should LCD liquid get into your mouth, immediately rinse your mouth out and contact your physician.

Should LCD liquid get in your eyes or on your skin, rinse with clean water and then contact your physician.

■ Battery Precautions

 **Should fluid leaking from a battery get on your skin or clothing, immediately rinse it off with clean water.**

Battery fluid getting into the eyes creates the risk of eyesight loss, etc.

Rinse the eyes and then immediately contact a physician.



Caution

Indicates something that creates the risk of minor personal injury or physical damage.

Observe the precautions below. Failure to do so can cause a battery to rupture, creating the risk of fire, personal injury, and soiling of nearby objects by leaking fluid.



- Do not try to take a battery apart and never allow a battery to become shorted.
- Do not charge a non-rechargeable battery.
- Do not expose a battery to heat or throw it into fire.

• Use only the specified type of battery.



- Load a battery with its poles (plus (+) and minus (-)) facing correctly.
- Replace the battery as soon as possible after it goes dead.



Battery Precautions



Observe the precautions below. Failure to do so can cause the battery to explode or leak flammable liquid or gas.

- Use only the type of battery that is specified for this product.
- Do not burn a battery or dispose of it in an incinerator, or by mechanical crushing or cutting.
- Do not subject a battery to excessively high or low temperatures during use, storage, or transport.
- Do not subject a battery to excessively low barometric pressure during use, storage, or transport.

Handling Precautions

- fx-83GT CW: Even if the calculator is operating normally, replace the battery at least once every two years (R03).
fx-85GT CW: Even if the calculator is operating normally, replace the battery at least once every two years (LR44).
A dead battery can leak, causing damage to and malfunction of the calculator. Never leave a dead battery in the calculator. Do not try using the calculator while the battery is completely dead (fx-85GT CW).
- You will be charged for malfunction or damage due to battery leakage, which is not covered by the warranty.
- The battery that comes with the calculator discharges slightly during shipment and storage. Because of this, it may require replacement sooner than the normal expected battery life.
- Avoid use and storage of the calculator in areas subjected to temperature extremes, and large amounts of humidity and dust.
- Do not subject the calculator to excessive impact, pressure, or bending.
- Never try to take the calculator apart.
- Use a soft, dry cloth to clean the exterior of the calculator.
- Whenever discarding the calculator or batteries, be sure to do so in accordance with the laws and regulations in your particular area.

Getting Started

Attaching and Removing the Front Cover

To remove the front cover

Before using the calculator, remove the front cover (①) and attach it to the back (②).

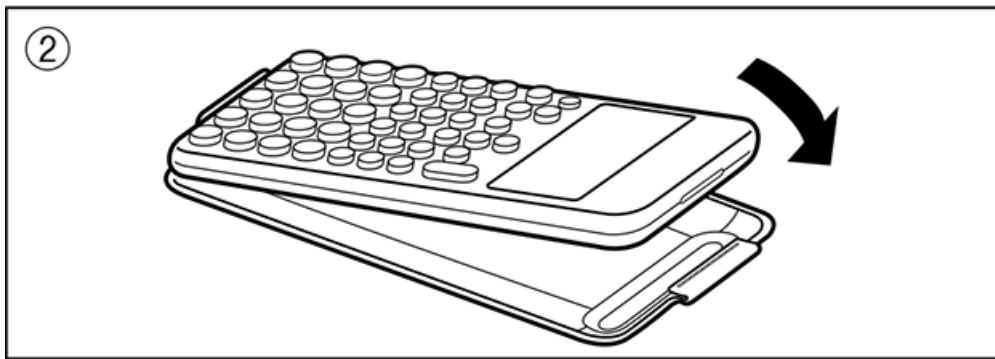
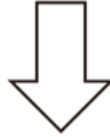
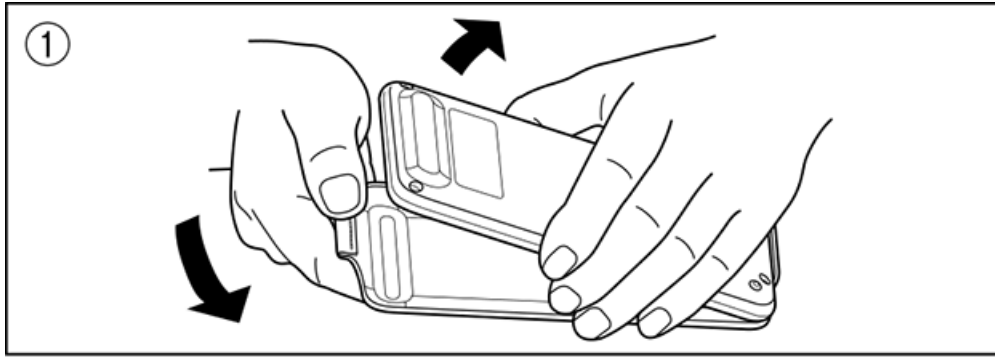

To attach the front cover

When you are not using the calculator, remove the front cover (①) and attach it to the front (②).

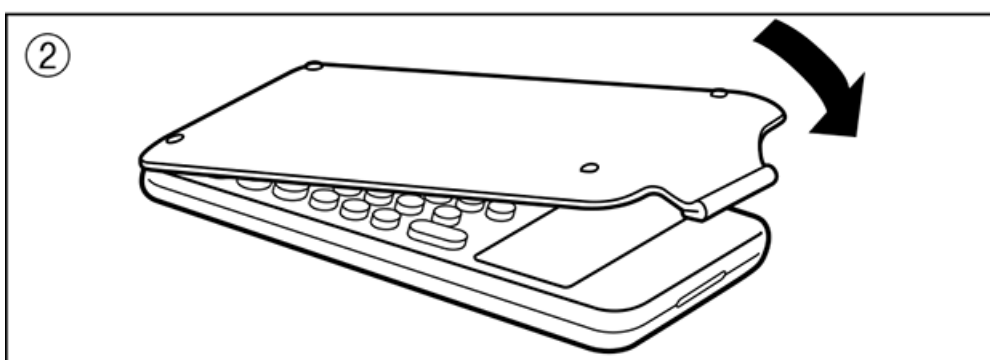
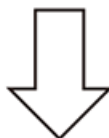
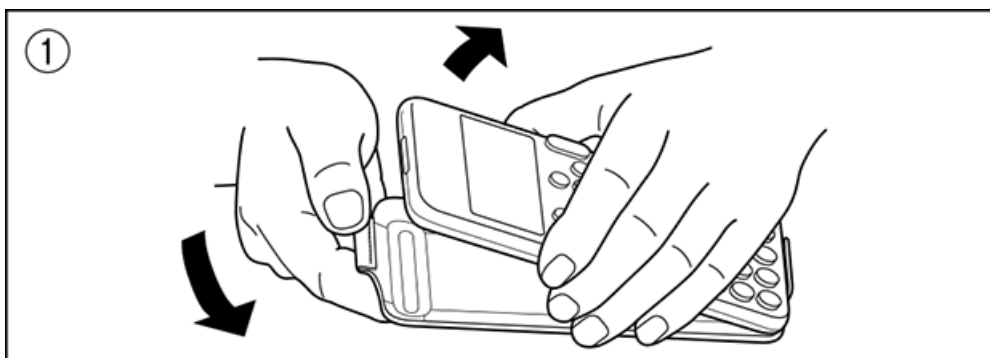



Important!



- Always attach the front cover to the calculator whenever you are not using it. Otherwise, accidental operation of the  key can cause the power to turn on and run down the battery.

Turning Power On and Off

Press  to turn on the calculator.

Press   (OFF) to turn off the calculator.

Note

- To turn on power, long-press . To avoid turning on power accidentally, the top of  key is slightly lower than the other keys.
- If the screen shown below appears right after you turn on power, it means that remaining battery power is low.



If this screen appears, replace the battery as soon as possible. For details about battery replacement, see ["Replacing the Battery" \(page 98\)](#).

- The calculator also will turn off automatically after approximately 10 minutes or 60 minutes of non-use. Press the  key to turn the calculator back on.

HOME Screen

Pressing \odot displays the HOME screen. The HOME screen shows a list of installed calculator apps.

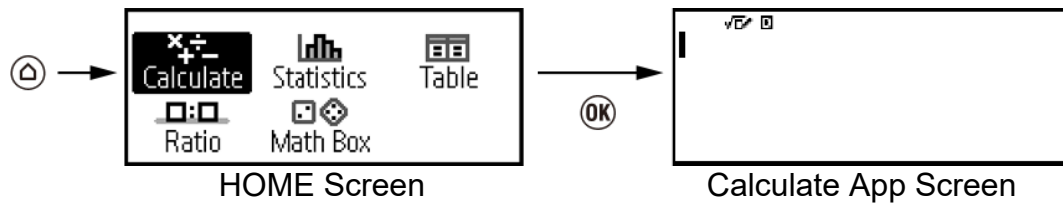

For information about installed calculator apps, see "[Installed Calculator App List](#)" (page 17).

Adjusting Display Contrast

1. Press \odot , select a calculator app icon, and then press OK .
2. Press Menu , and then select [System Settings] > [Contrast].

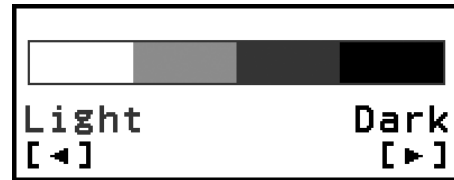

3. Use \leftarrow and \rightarrow to adjust display contrast.
4. After the setting is the way you want, press AC .

Important!

- If adjusting display contrast does not improve display readability, it probably means that battery power is low. Replace the battery.

Key Markings

Pressing the \uparrow key followed by a second key performs the alternate function of the second key. The alternate function is indicated by the text printed above the key, on the left.

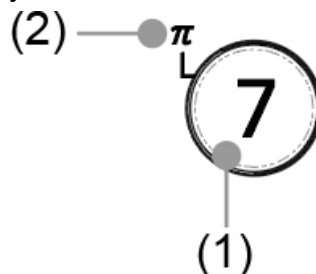

- (1) Keycap function: 7
- (2) Alternate function: $\uparrow \text{7} (\pi)$

Indicators

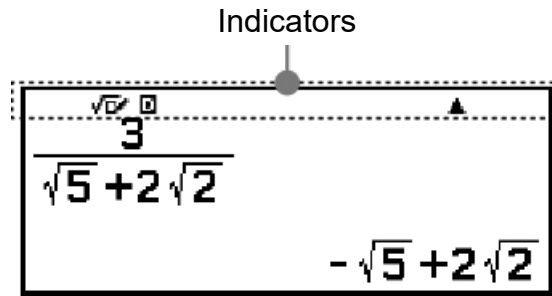

The table below describes indicators that appear at the top of the screen.

This indicator:	Means this:
S	The keypad has been shifted by pressing the key. The keypad will unshift and this indicator will disappear when you press a key.
	MathI/MathO or MathI/DecimalO is selected for Input/Output on the SETTINGS menu.
D / R / G	Current setting of Angle Unit (D : Degree, R : Radian, or G : Gradian) on the SETTINGS menu.
FIX	A fixed number of decimal places is in effect.
SCI	A fixed number of significant digits is in effect.
▲ / ▼	There is previous (▲) or following (▼) calculation history for the currently displayed calculation result.
	Calculator is being powered directly by its solar cells, either entirely or in some combination with the battery. (fx-85GT CW only)

Using Menus

Many of the operations of your calculator are performed using menu screens. The example below shows operations starting from the menu screen that appears when you press .

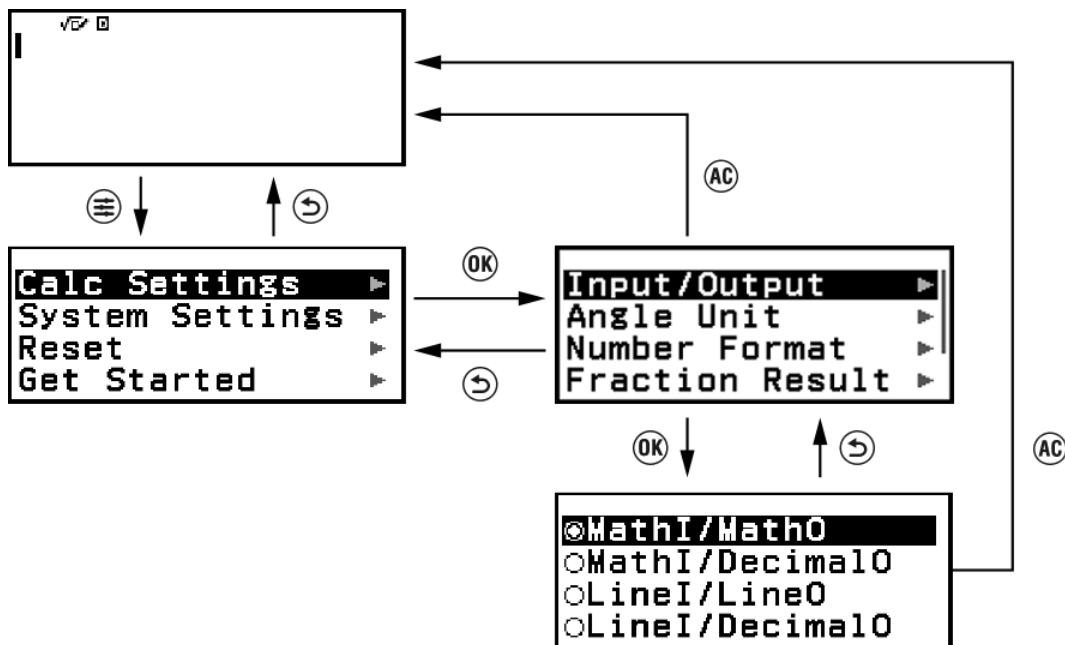

Selecting a Menu Item

To select a menu item, use the cursor keys (\uparrow , \downarrow , \leftarrow , \rightarrow) to highlight it and then press OK . Note that \leftarrow and \rightarrow are used only when there are multiple menu item columns.

Navigating Between Menu Hierarchies

The "▶" indicator to the right of a menu item means that there are lower hierarchy levels under that item. Selecting the menu item and pressing OK or \rightarrow navigates the next lower level of the hierarchy. To return to the next upper level of the hierarchy, press \leftarrow .

Note

- If you are in a lower level of the hierarchy of a one-column menu, you can press \leftarrow in addition to \leftarrow to return to the next higher level.

Selecting a Menu Item with a Radio Button (\circ/\bullet)

When the display shows a list of multiple options, each option will have a radio button (\circ or \bullet) to its left. \bullet indicates the currently selected option.

To configure the setting of a radio button menu item

1. Highlight the applicable menu item and then press OK .
 - What happens next depends on the type of menu item you selected.
 - If there are no more settings to configure for the menu item you selected, the radio button next to it will change to \bullet .

- The menu item you selected has more settings to configure, a screen for selecting the menu item setting will appear. In this case, proceed to step 2.
2. On the setting screen, highlight the setting you want and then press **OK**.
- This returns to the menu item screen in step 1, with the radio button next to the menu item you previously selected changed to **●**.

Scrolling Between Screens

A scroll bar will appear along the right side of the display when there are so many menu items that they do not fit on one screen.

- Use **▲** and **▼** to scroll between screens.
- Use **▲** and **▼** to scroll line-by-line.

To close the menu and return to the screen displayed before the menu

Press **AC**.

Note

- You can close a menu displayed by pressing **≡**, **2/3D**, **f(x)**, **□**, **000**, or **FORMA** by pressing **AC**. If the displayed menu is one that appears immediately after launching a particular calculator app or if it is an app-specific menu, you cannot close it by pressing **AC**. In that case, you must press **↶** to close the menu.

Calculator Apps and Menus

Calculator Apps

Selecting a Calculator App



Select a calculator app that is suitable for the type of calculation you want to perform.

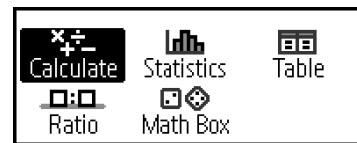

1. Press \odot to display the HOME screen.
 - For information about each calculator app, see the ["Installed Calculator App List" \(page 17\)](#).

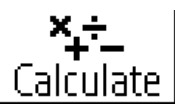

2. Use the cursor keys (\uparrow , \downarrow , \leftarrow , \rightarrow) to select the calculator app icon you want.
3. Press \odot to display the initial screen of the calculator app whose icon you selected.

Installed Calculator App List

Icon	Description
 Calculate (Calculate)	General calculations
 Statistics (Statistics)	Statistical and regression calculations
 Table (Table)	Generates a number table based on one or two functions

 Ratio (Ratio)	Ratio calculations
 Math Box (Math Box)	The following functions to support math learning. Dice Roll, Coin Toss: Probability simulation Number Line: Number line graphs for up to three equalities or inequalities Circle: Angles and trigonometric values shown using a Unit Circle or Half Circle figure. Angles can also be shown using a Clock figure.

Using the SETTINGS Menu

To display the SETTINGS menu, press  while using a calculator app. The SETTINGS menu includes the menu items below.



Calc Settings	Includes menu items for configuring calculation settings, such as the display format for calculation results.
System Settings	Includes menu items for configuring calculator operation settings, such as contrast adjustment.
Reset	Includes menu items for performing various types of reset operations.
Get Started	Displays the Get Started screen. For more information, see "Calculator "Get Started" Screen" (page 7) .

Note

- Pressing ☰ while the HOME screen is displayed will display the Get Started screen instead of the SETTINGS menu.
- Depending on the screen displayed by the calculator app, pressing ☰ may not display the SETTINGS menu.

Changing Calculator Settings

1. Press ⏏ , select a calculator app icon, and then press OK .
2. Press ☰ to display the SETTINGS menu.



3. Use ⬆ and ⬇ to select Calc Settings or System Settings, and then press OK .
 - This displays a list of setting items included on the selected menu. The screen here shows an example of what appears when [Calc Settings] is selected.

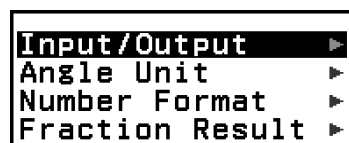

4. Use ⬆ and ⬇ to highlight the item whose setting you want to change, and then press OK .
 - See ["Items and Available Setting Options" \(page 19\)](#) for the setting items included for [Calc Settings] and [System Settings].
 - This displays a list of setting options for the item you selected. The screen here shows an example of what appears when [Input/Output] is selected.

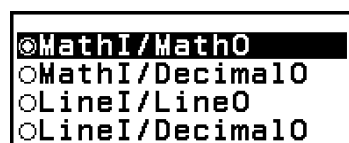

5. Use ⬆ and ⬇ to highlight the option you want, and then press OK .
6. After the setting is the way you want, press AC .

Items and Available Setting Options

"◆" indicates the initial default setting.

Calc Settings > Input/Output

Specifies the format to be used by the calculator for expression input and calculation result output.

MathI/MathO♦	Input: Natural Textbook; Output: Format that includes a fraction, $\sqrt{\quad}$, and/or π^{*1}
MathI/DecimalO	Input: Natural Textbook; Output: Converted to decimal value
LineI/LineO	Input: Linear ^{*2} ; Output: Decimal or fraction
LineI/DecimalO	Input: Linear ^{*2} ; Output: Converted to decimal value

*1 Decimal output is applied when these formats cannot be output for some reason.

*2 All calculations, including fractions and functions are input in a single line. Same output format as that for models without Natural Textbook Display (S-V.P.A.M. models, etc.)

Input/output format display examples:

MathI/MathO (initial default setting)	$\frac{1}{200}$ $\frac{1}{200}$
--	---------------------------------

MathI/DecimalO (Number Format: Norm 1)	$\frac{1}{200}$ 5×10^{-3}
---	------------------------------------

(Number Format: Norm 2)	$\frac{1}{200}$ 0.005
-------------------------	-------------------------

LineI/LineO	$1 \downarrow 200$ $1 \downarrow 200$
-------------	---------------------------------------

LineI/DecimalO (Number Format: Norm 2)	$1 \downarrow 200$ 0.005
---	----------------------------

Calc Settings > Angle Unit

Degree[♦]; Radian; Gradian

Specifies degree, radian or gradian as the angle unit for value input and calculation result display.

Calc Settings > Number Format

Specifies the number of digits for display of a calculation result.

Fix: The value you specify (from 0 to 9) controls the number of decimal places for displayed calculation results. Calculation results are rounded off to the specified digit before being displayed.

Example: $1 \div 6$

(Fix 3)

$1 \div 6 \uparrow \text{EXE} (\approx)^*$

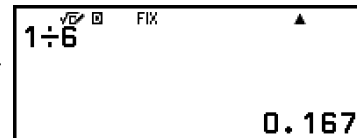

Sci: The value you specify (from 1 to 10) controls the number of significant digits for displayed calculation results. Calculation results are rounded off to the specified digit before being displayed.

Example: $1 \div 6$

(Sci 3)

$1 \div 6 \uparrow \text{EXE} (\approx)^*$

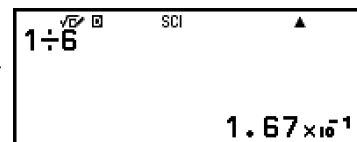

Norm: Displays calculation results in exponential format when they fall within the ranges below.

Norm 1: $10^{-2} > |x|$, $|x| \geq 10^{10}$, Norm 2[♦]: $10^{-9} > |x|$, $|x| \geq 10^{10}$

Example: $1 \div 200$

(Norm 1)

$1 \div 200 \uparrow \text{EXE} (\approx)^*$

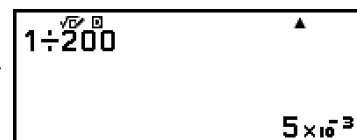

(Norm 2)

$1 \div 200 \uparrow \text{EXE} (\approx)^*$

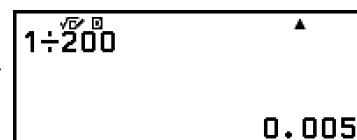

* Pressing \uparrow (EXE) (\approx) instead of (EXE) after inputting a calculation will display the calculation result in decimal form.

Calc Settings > Fraction Result

Mixed Fraction; Improper Fraction \blacklozenge

Specifies either mixed fraction or improper fraction for display of fractions in calculation results.

Calc Settings > Decimal Mark

Dot \blacklozenge ; Comma

Specifies whether to display a dot or a comma for the calculation result decimal mark. A dot is always displayed during input. When dot is selected as the decimal mark, the separator for multiple results is a comma (,). When comma is selected, the separator is a semicolon (;).

Calc Settings > Digit Separator

On \blacklozenge ; Off

Specifies whether or not a separator character should be used in calculation results.

System Settings > Contrast

See ["Adjusting Display Contrast" \(page 13\)](#).

System Settings > Auto Power Off

10 Min. \blacklozenge ; 60 Min.

Specify the amount of time until Auto Power Off is triggered.

System Settings > MultiLine Font

Normal Font \blacklozenge ; Small Font

Specifies the display font size when LineI/LineO or LineI/DecimalO is selected for Input/Output. Up to four lines can be displayed while Normal Font is selected, and up to six lines can be displayed with Small Font.

System Settings > QR Code

Specifies the version of the QR Code displayed when \uparrow \otimes (QR) is pressed.

Version 3: Indicates QR Code Version 3.

Version 11 \blacklozenge : Indicates QR Code Version 11.

Reset > Settings & Data

See ["To initialize calculator settings" \(page 23\)](#).

Reset > Variable Memory

See ["Clearing the Contents of All Memories" \(page 36\)](#).

Reset > Initialize All

See ["Initializing the Calculator" \(page 7\)](#).

Get Started

See ["Calculator "Get Started" Screen" \(page 7\)](#).

To initialize calculator settings

Important!

- The procedure below initializes all calculator settings, except for Contrast and Auto Power Off. Also clears all data except for variable memory and Ans data.

1. Press \uparrow , select a calculator app icon, and then press \otimes .
2. Press \equiv , and then select [Reset] > [Settings & Data] > [Yes].
 - This displays the HOME screen.

Using the CATALOG Menu

Press \otimes to display the CATALOG menu. This menu shows categories of the commands, functions, and symbols in accordance with the calculator app you are currently using and the current status (displayed screen or current settings) of the app.

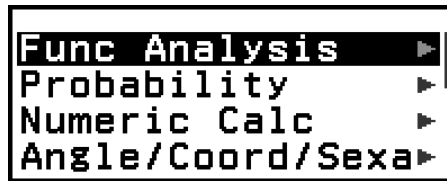

Example: CATALOG menu of the Calculate app

Note

- For information about how to input commands, functions, and symbols from the CATALOG menu, see ["Advanced Calculations" \(page 45\)](#).
- For information about the commands, functions, and symbols specific to each calculator app, refer to the calculator app descriptions in ["Using Calculator Apps" \(page 58\)](#).

Using the TOOLS Menu

The TOOLS menu that appears when you press \odot includes menu items for performing functions specific to each calculator app and for configuring settings.

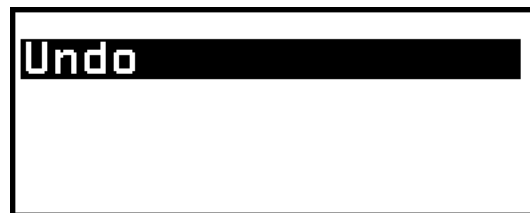

Example: TOOLS menu for the Calculate app

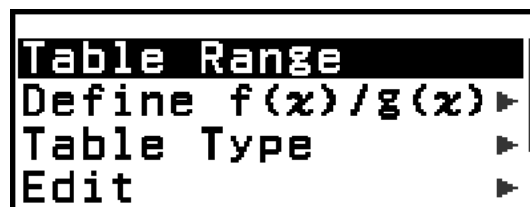

Examples: TOOLS menu for the Table app

Note

- The menu items below are common to multiple calculator apps.
 - Undo (See ["Undo Operations" \(page 27\)](#).)

Inputting Expressions and Values

Basic Input Rules

When you press EXE the priority sequence of the input calculation will be evaluated automatically and the result will appear on the display.

$$4 \times \sin 30 \times (30 + 10 \times 3) = 120$$

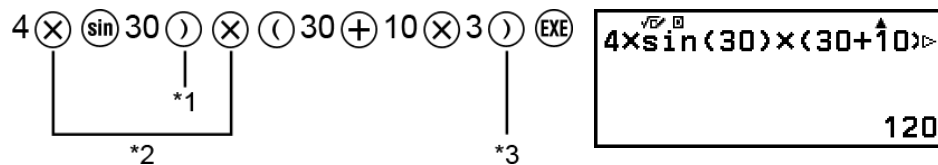

- *1 Input of the closing parenthesis is required for sin and other functions that include parentheses.
- *2 These multiplication symbols (x) can be omitted.
- *3 The closing parenthesis immediately before the EXE operation can be omitted.

Moving the Cursor to the Beginning or End of an Input Expression

While inputting an expression, you can press HOME to make the cursor jump to the beginning of the expression or END to jump to the end of the expression.

Input Expression and Calculation Result "More" Indicator (▶, ▶-)

If you see a pointer (▶ or ▶-) symbol on the right side of either an input expression line or calculation result line, it means the displayed line continues to the right. Use LEFT and RIGHT to scroll the line left and right.

- When you see ▶ at the right end of a calculation result line, you can jump to the end of the result by pressing END . To jump to the beginning of a calculation result line, press HOME .
- Note that if you want to scroll the input expression while both the ▶ and ▶- indicators are displayed, you will need to press ON or AC first and then use LEFT and RIGHT to scroll.

Pol(1.414213562,
r=2, θ=0.785398163▶

Parentheses Auto Complete

If you execute a calculation that includes both division and multiplication operations in which a multiplication sign has been omitted, parentheses will be inserted automatically as shown in the examples below.

- When a multiplication sign is omitted immediately before an open parenthesis or after a closing parenthesis.

Example: $6 \div 2(1 + 2) \rightarrow 6 \div (2(1 + 2))$

- When a multiplication sign is omitted immediately before a variable, a constant, etc.

Example: $6 \div 2\pi \rightarrow 6 \div (2\pi)$

Input Limit Indication

The cursor will change shape to ■ when there are 10 bytes or less of allowed input remaining. If this happens, end calculation input and then press EXE .

Inputting an Expression Using Natural Textbook Format (MathI/MathO or MathI/DecimalO Only)

Expressions that include fractions and/or special functions such as $\sqrt{\quad}$ can be input in natural textbook format by using templates that appear when certain keys are pressed, or when you input certain functions from the CATALOG menu.

Example: $3\frac{1}{2} + 5\frac{3}{2}$

1. Press \uparrow $\frac{\square}{\square}$ ($\frac{\square}{\square}$).

- This inputs a mixed fraction template.

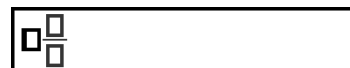

2. Input values into the integer, numerator, and denominator areas of the template.

Basic Calculations

Arithmetic Calculations

Use the \oplus , \ominus , \otimes , and \odiv keys to perform arithmetic calculations.

Example: $7 \times 8 - 4 \times 5 = 36$

$7 \otimes 8 \ominus 4 \otimes 5 \text{EXE}$

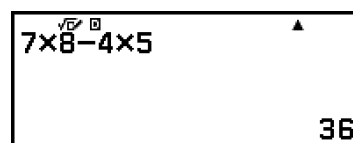

Fraction Calculations

Note that the input method for fractions depends on the current Input/Output setting on the SETTINGS menu.

To input $\frac{7}{3}$ (improper fraction)

(Input/Output: MathI/MathO or MathI/DecimalO)

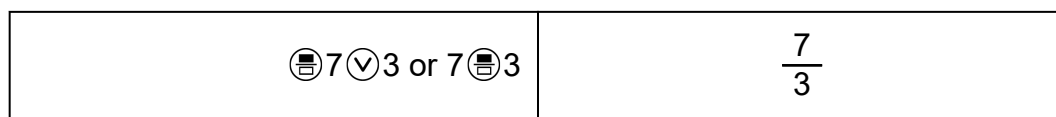

(Input/Output: LineI/LineO or LineI/DecimalO)

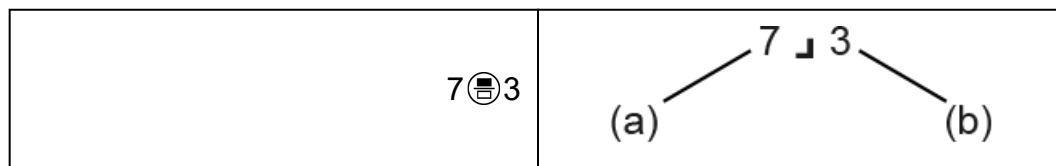

(a) Numerator, (b) Denominator

To input $2 \frac{1}{3}$ (mixed fraction)

(Input/Output: MathI/MathO or MathI/DecimalO)

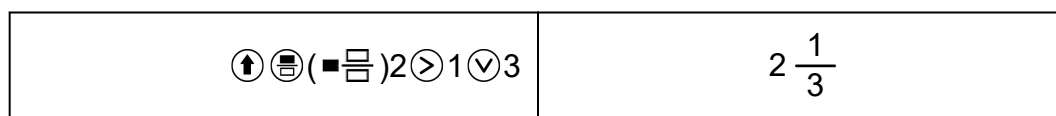

(Input/Output: LineI/LineO or LineI/DecimalO)

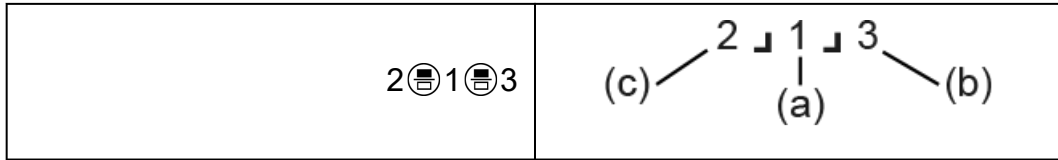

(a) Numerator, (b) Denominator, (c) Integer Part

Example: $\frac{2}{3} + 1\frac{1}{2} = \frac{13}{6}$

(Input/Output: MathI/MathO)

$2 \frac{1}{3} \text{ (Frac)} \text{ (>) } + \text{ (Frac)} \text{ (1) } \frac{1}{2} \text{ (Frac)} \text{ (EXE)}$



(Input/Output: LineI/LineO)

$2 \frac{1}{3} \text{ (Frac)} \text{ (+) } 1 \frac{1}{2} \text{ (Frac)} \text{ (EXE)}$

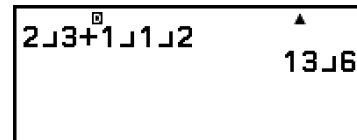

Note

- Fractions in calculation results are displayed after being reduced to their lowest terms.

To convert a calculation result format to improper fraction or mixed fraction, press FORMAT . For more information, see ["Improper Fraction and Mixed Fraction Conversion" \(page 42\)](#).

Fraction Format Calculation Results

A calculation result whose total number of mixed fraction number of digits (including integer, numerator, denominator, and separator symbol $\frac{_}{_}$) is greater than 10 cannot be displayed using fraction format. In this case, the calculation result is displayed as a decimal value.

Example 1: $1\frac{1}{1} \frac{123456}{123456} = 123457\frac{1}{123456}$

(Input/Output: LineI/LineO)

$1 \frac{1}{1} \text{ (Frac)} \frac{123456}{123456} \text{ (Frac)} \text{ (EXE)}$

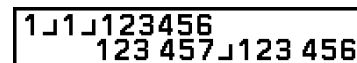

Since the total number of digits of the value $1\frac{1}{1} \frac{123456}{123456}$ is 10, the result is displayed as a fraction value.

Example 2: $1\frac{1}{1} \frac{1234567}{1234567} (= 1234568\frac{1}{1234567}) = 1.00000081$

(Input/Output: LineI/LineO)

1 $\frac{\square}{\square}$ 1 $\frac{\square}{\square}$ 1234567 $\frac{\square}{\square}$ EXE 1 $\frac{\square}{\square}$ 1 $\frac{\square}{\square}$ 1234567
1.00000081

Since the total number of digits of the value $1 \frac{\square}{\square} 1 \frac{\square}{\square} 1234567$ is 11, the result is displayed as a decimal value.

Note

- Mixing fractions and decimal values in a calculation while something other than MathI/MathO is selected will cause the result to be displayed as a decimal value.

Powers, Power Roots, and Reciprocals

Use the keys below to input power functions, power root functions, and reciprocal function.

Power functions: $\frac{\square}{\square}$ (square), $\frac{\square}{\square}$ (n^{th} power)

Power root functions: $\sqrt{\square}$ (square root), $\sqrt[n]{\square}$ (n^{th} root)

Reciprocal function: $\frac{\square}{\square}$ (\square^{-1})

Example 1: $(5^2)^3 = 15625$

(5 $\frac{\square}{\square}$) $\frac{\square}{\square}$ 3 EXE

 $\sqrt{\square} \frac{\square}{\square}$
 $(5^2)^3$
15 625

Example 2: $(1 + 1)^{2+2} = 16$

(1 + 1) $\frac{\square}{\square}$ 2 + 2 EXE

 $\sqrt{\square} \frac{\square}{\square}$
 $(1+1)^{2+2}$
16

Example 3: $\sqrt{2} \times 3 = 3\sqrt{2} = 4.242640687\dots$

(Input/Output: MathI/MathO)

$\sqrt{\square}$ 2 > \times 3 EXE

 $\sqrt{\square} \frac{\square}{\square}$
 $\sqrt{2} \times 3$
 $3\sqrt{2}$

(Input/Output: LineI/LineO)

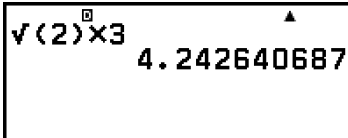
$$\sqrt{\square} 2 \text{) } \times 3 \text{ EXE}$$



Example 4: ${}^5\sqrt{32} = 2$
 (Input/Output: MathI/MathO)

$$\uparrow \sqrt{\square} (\sqrt{\square}) 5 > 32 \text{ EXE}$$

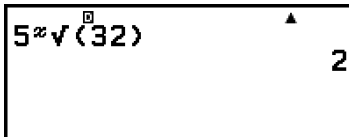
(Input/Output: LineI/LineO)

$$5 \uparrow \sqrt{\square} (\sqrt{\square}) 32 \text{) EXE}$$

Example 5: $10^{-1} = \frac{1}{10}$
 (Input/Output: MathI/MathO)

$$10 \uparrow \square^{-1} \text{ EXE}$$

$\times 10^{\square}$ Key (Power of 10)

Pressing the $\times 10^{\square}$ key is the same as pressing $\times 1 \text{ 0 } \square^{\square}$. Both operations input " $\times 10^{\square}$ " (MathI/MathO or MathI/DecimalO) or " $\times 10^{\square}$ " (LineI/LineO or LineI/DecimalO).

Example: $1.23 \times 10^3 = 1230$

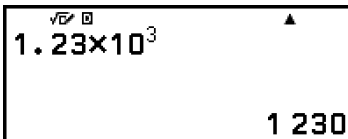
$$1 \text{ . } 23 \times 10^{\square} 3 \text{ EXE}$$

$\sqrt{\square}$ Form Calculation Range

The allowable display ranges of the $\sqrt{\square}$ form calculation result are shown below.

$$\pm a\sqrt{b}, \pm d \pm a\sqrt{b}, \pm \frac{a\sqrt{b}}{c} \pm \frac{d\sqrt{e}}{f}$$

$$1 \leq a < 100, 1 < b < 1000, 1 \leq c < 100$$

$$0 \leq d < 100, 0 \leq e < 1000, 1 \leq f < 100$$

Example:

- $10\sqrt{2} + 15 \times 3\sqrt{3} = 45\sqrt{3} + 10\sqrt{2} \dots$ Displayed in $\sqrt{\quad}$ form
- $99\sqrt{999} (= 297\sqrt{111}) = 3129.089165 \dots$ Displayed as a decimal value

Pi, Natural Logarithm Base e

Pi

Input π by pressing \uparrow $\textcircled{7}$ (π).

π is displayed as 3.141592654, but $\pi = 3.1415926535897932384626$ is used for internal calculations.

Natural Logarithm Base e

Input e by pressing \uparrow $\textcircled{8}$ (e).

Natural Logarithm Base e is displayed as 2.718281828, but $e = 2.7182818284590452353602$ is used for internal calculations.

Calculation History and Replay

Calculation History

An \blacktriangle and/or \blacktriangledown at the top of the screen indicates more calculation history content above and/or below. You can scroll through calculation history contents using $\textcircled{\wedge}$ and $\textcircled{\vee}$.

Calculation history can be used only in the Calculate app.

Example

$2 + 2 = 4$

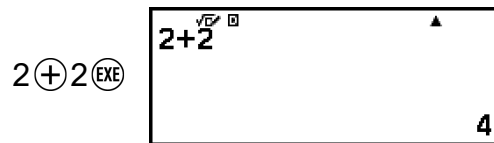

$3 + 3 = 6$

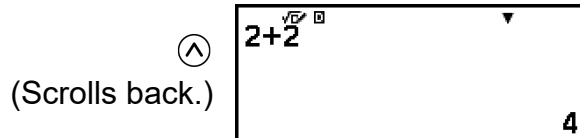
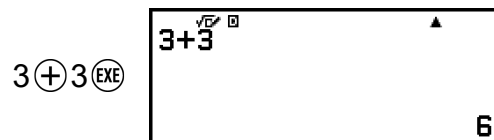

Note

- Calculation history data is all cleared whenever you press C or C , when you change the Input/Output setting, or whenever you perform a Reset operation ("Settings & Data" or "Initialize All").

Replay

While a calculation result is on the display, you can press ◀ , ▶ or ↶ to edit the expression you used for the previous calculation.

Example

$$4 \times 3 + 2 = 14$$

$$4 \text{ (X) } 3 \text{ (+) } 2 \text{ (EXE)}$$

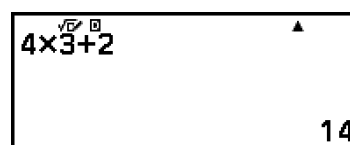

A calculator display showing the expression $4 \times 3 + 2$ and the result 14 . The display has a small triangle cursor at the top right.

$$4 \times 3 - 7 = 5$$

(Continuing) $\text{◀} \text{ (X) } \text{ (X) } \text{ (X) } - 7 \text{ (EXE)}$

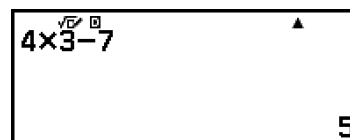

A calculator display showing the expression $4 \times 3 - 7$ and the result 5 . The display has a small triangle cursor at the top right.

Note

- If ◀ (left) or ▶ (right) is displayed on either end or both ends of a calculation result line, you can use ◀ and ▶ to scroll the line left and right. If this happens, press ↶ or AC first, and then use ◀ and ▶ to edit the expression.

Using Memory Functions

Answer Memory (Ans)

The last calculation result obtained is stored in Ans (answer) memory.

Using Ans Memory to Perform a Series of Calculations

Example: To divide the result of 3×4 by 30

$$3 \text{ (X) } 4 \text{ (EXE)}$$

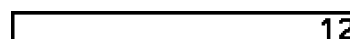

A calculator display showing the result 12 .

(Continuing) $\text{ (DIV) } 30 \text{ (EXE)}$

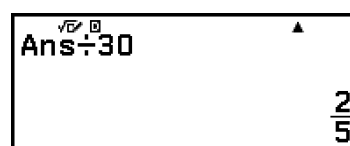

A calculator display showing the expression $\text{Ans} \div 30$ and the result $\frac{2}{5}$. The display has a small triangle cursor at the top right.

Inputting Ans Memory Contents into an Expression

Example: To perform the calculations shown below:

$$123 + 456 = 579 \qquad 789 - 579 = 210$$

$$123 \oplus 456 \text{ EXE} \quad \boxed{579}$$

(Continuing) $789 \ominus \text{Ans} \text{ EXE}$

Variables (A, B, C, D, E, F, x, y, z)

You can store values to variables and use the variables in calculations.

Variable List Screen

A=36	B=123 456
C=1 234 567	D=12 345 678
E=123 456 789	F=1 234 567 890
x=1.2345×10 ¹⁰	y=0
z=0	

Pressing $\text{2nd} \text{ } \text{2nd}$ displays a screen that shows the values currently stored to variables A, B, C, D, E, F, x, y, and z. On this screen, values are always displayed using the "Norm 1" Number Format. To close the screen, press $\text{2nd} \text{ } \text{2nd}$ or AC .

Example 1: To store the result of $3 + 5$ to variable A

1. Execute the calculation.

$$3 \oplus 5 \text{ EXE} \quad \boxed{3+5 \quad 8}$$

2. Press $\text{2nd} \text{ } \text{2nd}$, and then select [A=] > [Store].

- This stores the result of $3 + 5$ (which is 8) to variable A.

3. Press $\text{2nd} \text{ } \text{2nd}$.

Example 2: To change the contents of variable A to 1

1. Press $\text{2nd} \text{ } \text{2nd}$, and then highlight [A=].

2. Press $\text{\textcircled{1}}$.

- This displays the editing screen with 1 entered.



A=1

3. Press $\text{\textcircled{EXE}}$.



A=1 B=0

Note

- In place of the operation in step 2 above, you can press $\text{\textcircled{OK}}$ and then select [Edit]. This displays the editing screen with nothing input. Input the value you want and then press $\text{\textcircled{EXE}}$.
- If a lock ($\text{\textcircled{L}}$) icon appears when you highlight a variable on the variable list screen, it means the highlighted variable cannot be edited.

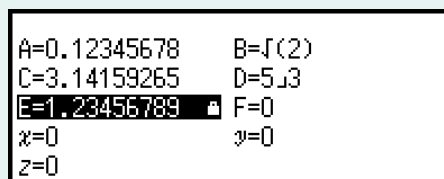

A=0.12345678 B=J(2)
C=3.14159265 D=5.3
E=1.23456789 $\text{\textcircled{L}}$ F=0
x=0 y=0
z=0

Example 3: To recall the contents of variable A
(Continuing from step 2 of Example 1)

1. Press $\text{\textcircled{2.3}}$, and then select [A=] > [Recall].

- This inputs "A".



A

2. Press $\text{\textcircled{EXE}}$.

- This recalls the value of variable A.



A $\text{\textcircled{L}}$ \blacktriangle
8

Example 4: To multiply the contents of variable A by 10
(Continuing from step 2 of Example 1)

$\text{\textcircled{\uparrow}} \text{\textcircled{4}} (A) * \text{\textcircled{\times}} 10 \text{\textcircled{EXE}}$



A $\text{\textcircled{L}}$ \blacktriangle
A x 10
80

* Input a variable as shown here: press $\text{\textcircled{\uparrow}}$ and then press the key that corresponds to the desired variable name. To input x as the variable name, you can press $\text{\textcircled{\uparrow}} \text{\textcircled{0}} (x)$ or $\text{\textcircled{\times}}$.

Clearing the Contents of All Memories

Ans memory and variable contents are retained even if you press **AC**, change the calculator app, or turn off the calculator.

Perform the procedure below when you want to clear the contents of all memories.

1. Press **⏪**, select a calculator app icon, and then press **OK**.
2. Press **☰**, and then select [Reset] > [Variable Memory] > [Yes].

Changing Calculation Result Format

Using the FORMAT Menu



You can use the FORMAT menu that appears when you press  to convert a displayed calculation result to various formats.



FORMAT Menu List

This menu item:	Converts to this format:
Standard	Standard (Includes fraction, π , $\sqrt{\quad}$ formats.)
Decimal	Decimal
Prime Factor	Prime factorization
Recurring Decimal	Recurring decimal
Improper Fraction	Improper fraction
Mixed Fraction	Mixed fraction
ENG Notation	Engineering notation ($a \times 10^n$ format, n = exponent divisible by 3)
Sexagesimal	Degree, minute, second (Sexagesimal)

Note

- The menu items that appear when  is pressed depend on the currently displayed calculation result. Also, if a calculation result that cannot be converted is displayed, the menu will not appear when you press .

Conversion Sample Operation

Example: $3 \div 2 = \frac{3}{2} = 1.5 = 1 \frac{1}{2}$

In this example, we will convert a calculation result displayed as an improper fraction to a decimal value and then to a mixed fraction. Finally, we will cancel the conversion and go back to the original calculation result. (Input/Output: MathI/MathO, Fraction Result: Improp Fraction)

1. Execute the calculation $3 \div 2$.

$3 \div 2$ (EXE)



The calculator display shows the expression $3 \div 2$ in the top left corner. In the bottom right corner, the result is displayed as the improper fraction $\frac{3}{2}$. The display also shows a small triangle cursor in the top right corner.

2. To convert the calculation result to a decimal value, press (FORMAT), select [Decimal], and then press (EXE).



The calculator display shows the expression $3 \div 2$ in the top left corner. In the bottom right corner, the result is displayed as the decimal value 1.5. The display also shows a small triangle cursor in the top right corner.

3. To convert the calculation result to a mixed fraction, press (FORMAT), select [Mixed Fraction], and then press (EXE).



The calculator display shows the expression $3 \div 2$ in the top left corner. In the bottom right corner, the result is displayed as the mixed fraction $1 \frac{1}{2}$. The display also shows a small triangle cursor in the top right corner.

4. To cancel conversion, press (EXE).
 - This displays the original calculation result from step 1.



The calculator display shows the expression $3 \div 2$ in the top left corner. In the bottom right corner, the result is displayed as the improper fraction $\frac{3}{2}$. The display also shows a small triangle cursor in the top right corner.

Standard and Decimal Conversion



Standard is a format that displays a calculation result in a form that includes a fraction, $\sqrt{\quad}$, or π when possible. Decimal is a format that displays the calculation result as a decimal value.

Note

- Conversion to Standard format that includes $\sqrt{\quad}$ or π is possible when MathI/MathO or MathI/DecimalO is selected for the Input/Output setting on the SETTINGS menu.

You can use the operation below to convert a calculation result to the Standard or Decimal format.

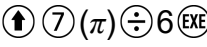
Example: $\pi \div 6 = \frac{1}{6} \pi = 0.5235987756$ (Input/Output: MathI/MathO)



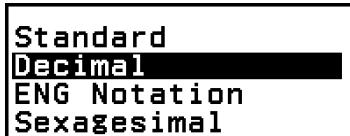

 (Select [Decimal].)

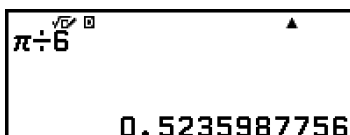
 (Converts to a decimal value.)

 (Converts to Standard format.)

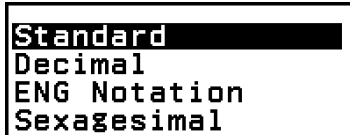
Important!

- With certain calculation results, selecting [Standard] on the FORMAT menu will not convert the displayed value.

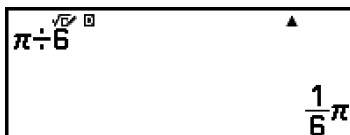
To obtain a decimal value calculation result while MathI/MathO or LineI/LineO is selected

Press   (\approx) instead of  after inputting a calculation.

Prime Factorization

In the Calculate app, a positive integer no more than 10 digits long can be factored to prime factors.

Example: To perform prime factorization on 1014

1014 (EXE)



(FORMAT) – [Prime Factor]

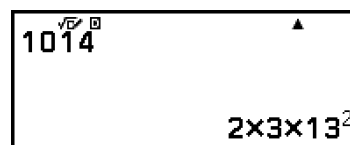

Note

- The types of values described below cannot be factored, even if they have 10 or fewer digits.
 - One of the prime factors of the value is 1,018,081 or greater.
 - Two or more of the prime factors of the value have more than three digits.
- The part that cannot be factored is enclosed in parentheses on the display.

Example: $2036162 = 2 \times (1018081)^*$

*1018081 = 1009^2

2036162 (EXE)
(FORMAT) – [Prime Factor]

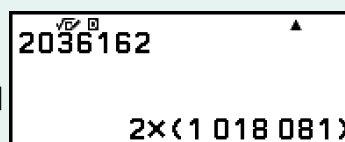

Recurring Decimal Conversion (Recurring Decimal Calculations)

Your calculator lets you convert a calculation result to recurring decimal format in the Calculate app when possible. It also makes it possible for you to input a recurring decimal value and perform a calculation.

Converting a Calculation Result to a Recurring Decimal Value

To convert a calculation result to a recurring decimal value, press (FORMAT), and then select [Recurring Decimal] from the FORMAT menu that appears. For the actual operation, see ["Recurring Decimal Calculation Example" \(page 41\)](#).

Inputting a Recurring Decimal

To input a recurring decimal value, use (↑) (■) (■) or the CATALOG menu item shown below.

(M) – [Numeric Calc] > [Recurring Decimal]

For the actual operation, see ["Recurring Decimal Calculation Example" \(page 41\)](#).

Improper Fraction and Mixed Fraction Conversion

You can convert the currently displayed fraction or decimal value (decimal value that is convertible to a fraction by this calculator) calculation result to a mixed fraction or an improper fraction.

Example 1: $\frac{13}{4} = 3 \frac{1}{4}$

(Input/Output: MathI/MathO, Fraction Result: Improp Fraction)

13	⊞	4	EXE	$\frac{13}{4}$
	⊞	– [Mixed Fraction]		$3\frac{1}{4}$
	⊞	– [Improper Fraction]		$\frac{13}{4}$

Example 2: $3.25 = \frac{13}{4} = 3 \frac{1}{4}$ (Input/Output: LineI/LineO)

3	⊙	25	EXE	3.25
	⊞	– [Improper Fraction]		13┘4
	⊞	– [Mixed Fraction]		3┘1┘4

Engineering Notation

You can convert the exponent part of a displayed calculation result value to a power of ten that is a multiple of 3, and displays the result.

Example: Transform the value 1234 to engineering notation, shifting the decimal mark to the right, and then to the left.

1. Input 1234, and then press EXE .

$\sqrt{\text{E}} \text{D}$ 1234	▲
1 234	

2. Perform the operation below to enter the ENG Conversion Mode.

⊞	– [ENG Notation]	$\sqrt{\text{E}} \text{D}$ 1234	▲
		1.234 × 10 ³	

- Entering the ENG Conversion Mode converts the calculation result to engineering notation and causes $\frac{\sqrt{\square}}{\square}$ to appear to its right.
- In the ENG Conversion Mode, you can use \leftarrow and \rightarrow to shift the decimal point of the mantissa.

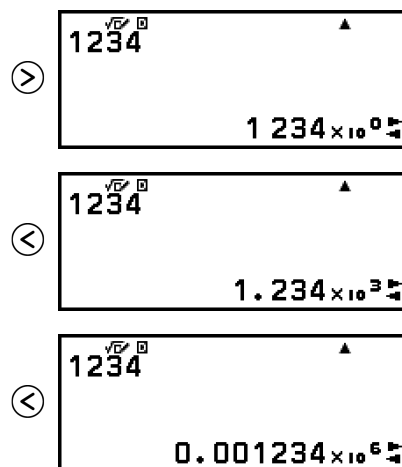

3. To exit the ENG Conversion Mode, press \rightarrow .

- This exits the ENG Conversion Mode and causes $\frac{\sqrt{\square}}{\square}$ to disappear from the display.



- You can also exit the ENG Conversion Mode by pressing OK or AC .

Note

- Normal calculations are not possible while in the ENG Conversion Mode. To start a new calculation, exit the ENG Conversion Mode.

Sexagesimal Conversion (Degree, Minute, Second Calculations)

You can convert a decimal value calculation result to a sexagesimal value.

Converting a Decimal Value Calculation Result to a Sexagesimal Value

Example: $1.25 = 1^{\circ}15'0''$

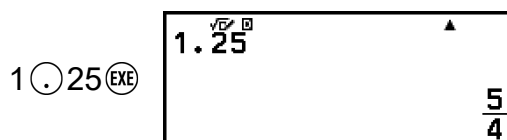

 – [Sexagesimal]

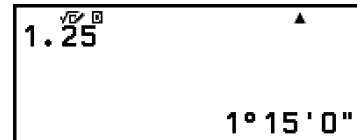

Inputting and Calculating with a Sexagesimal Value

In addition to converting a displayed value to a sexagesimal value, you can also input sexagesimal values and use them in calculations.

The syntax below is for inputting a sexagesimal value:

{degrees}   (°) {minutes}   (°) {seconds}   (°)

Note that you must always input something for the degrees and minutes, even if they are zero.

Example: To perform the calculation $2^{\circ}20'30'' + 9'30''$. Next, convert the calculation result to a decimal value.

2   (°) 20   (°) 30   (°)
 0   (°) 9   (°) 30   (°) 

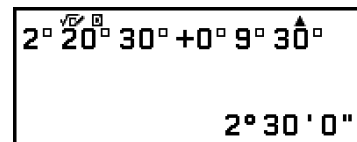

(Convert to a decimal value.)

 – [Decimal]

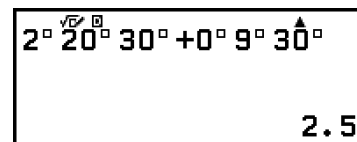

(Return to sexagesimal display.)

 – [Sexagesimal]

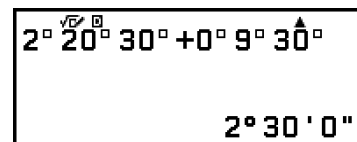

Advanced Calculations

This section describes commands, functions, and symbols that are common to all of the calculator apps. The order used here to present commands, functions, and symbols is the same order in which they are displayed on the CATALOG menu that appears when you press ☞ .

Note

- There are also calculator app-specific CATALOG menu items, which are not shown here. See the chapter for each calculator app for more information about app-specific menu items.
- Depending on the calculator app you are using and the screen displayed by the calculator app, you may not be able to input some commands, functions, or symbols. Commands, functions, and symbols that cannot be input do not appear on the CATALOG menu.

Function Analysis

This section explains commands and functions that you can input after performing the operation: ☞ – [Func Analysis].

Logarithm(logab), Logarithm(log)

Use ☞ – [Func Analysis] > [Logarithm(log)] to input $\log_a b$ as $\log(a, b)$. Base 10 is the initial default setting if you do not input anything for a .

Example 1: $\log_{10} 1000 = \log 1000 = 3$

☞ – [Func Analysis] > [Logarithm(log)] 1000 ☞
 EXE

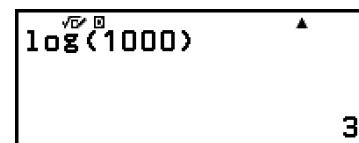

Example 2: $\log_2 16 = 4$

☞ – [Func Analysis] > [Logarithm(log)] 2 ☞
(,)16 ☞ EXE

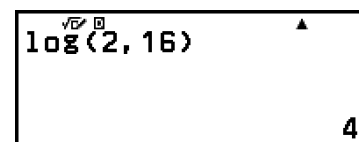

The ☞ key (or ☞ – [Func Analysis] > [Logarithm(logab)]) also can be used for input, but only while MathI/MathO or MathI/DecimalO is selected for Input/Output on the SETTINGS menu. In this case, you must input a value for the base.

Example 3: $\log_2 16 = 4$

$\log_2 16$ 



Natural Logarithm

Use   (ln) or  – [Func Analysis] > [Natural Logarithm] to input "ln".

Example: $\ln 90 (= \log_e 90) = 4.49980967$

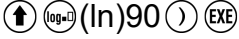
$\ln 90$ 

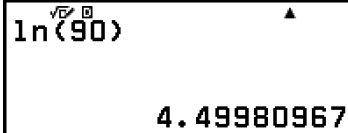

Probability

This section explains commands and functions that you can input after performing the operation:  – [Probability].

%

Inputting a value followed by % command causes the input value to become a percent.

Example 1: $150 \times 20\% = 30$

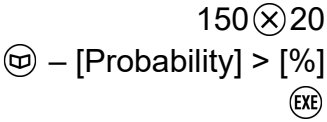
$150 \times 20\%$ 

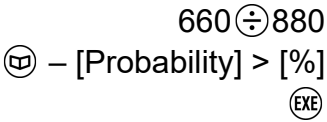

Example 2: Calculate what percentage of 880 is 660. (75%)

$660 \div 880$ 

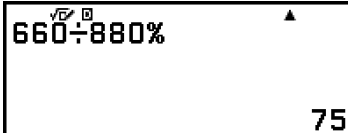

Example 3: Discount 3500 by 25%. (2625)

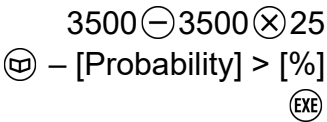
$3500 - 3500 \times 25\%$ 

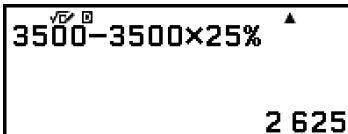

Factorial(!)

This function obtains the factorials of a value that is zero or a positive integer.

Example: $(5 + 3)! = 40320$

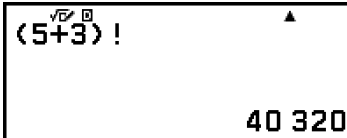
$$\text{2nd} - [\text{Probability}] > [\text{Factorial(!)}]$$



The calculator screen displays the expression $(5+3)!$ and the result 40320 .

Permutation(P), Combination(C)

Permutation (${}_nP_r$) and combination (${}_nC_r$) functions.

Example: To determine the number of permutations and combinations possible when selecting four people from a group of 10

Permutations:

$$\text{2nd} - [\text{Probability}] > [\text{Permutation(P)}]$$

The calculator screen displays the expression $10P4$ and the result 5040 .

Combinations:

$$\text{2nd} - [\text{Probability}] > [\text{Combination(C)}]$$

The calculator screen displays the expression $10C4$ and the result 210 .

Random Number

This function generates a pseudo random number in the range of 0.000 to 0.999. The result is displayed as a fraction when MathI/MathO is selected for Input/Output on the SETTINGS menu.

Example: To obtain random three-digit integers

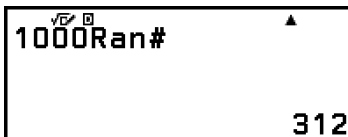
$$\text{2nd} - [\text{Probability}] > [\text{Random Number}]$$

The calculator screen displays the expression $1000\text{Ran}\#$ and the result 312 .

(The result differs with each execution.)

Random Integer

This function generates a pseudo random integer between a specified start value and end value.

Example: To generate random integers in the range of 1 to 6

☞ – [Probability] > [Random Integer]
1 \uparrow ☉ (,) 6 ☉ EXE

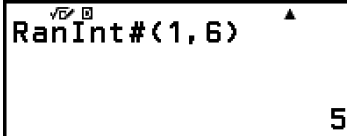

The calculator display shows the function $\text{RanInt}\#(1, 6)$ and the result 5.

(The result differs with each execution.)

Numeric Calculations

This section explains commands and functions that you can input after performing the operation: ☞ – [Numeric Calc].

GCD, LCM

GCD determines the greatest common divisor of two values, while LCM determines the least common multiple.

Example 1: To determine the greatest common divisor of 28 and 35

☞ – [Numeric Calc] > [GCD]
28 \uparrow ☉ (,) 35 ☉ EXE

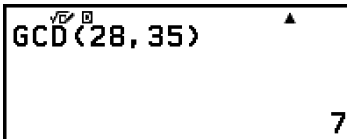

The calculator display shows the function $\text{GCD}(28, 35)$ and the result 7.

Example 2: To determine the least common multiple of 9 and 15

☞ – [Numeric Calc] > [LCM]
9 \uparrow ☉ (,) 15 ☉ EXE

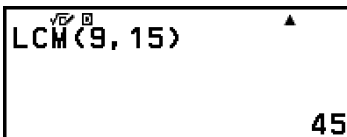

The calculator display shows the function $\text{LCM}(9, 15)$ and the result 45.

Absolute Value

When you are performing a real number calculation, this function simply obtains the absolute value.

Example: $|2 - 7| = \text{Abs}(2 - 7) = 5$

(Input/Output: MathI/MathO)

☞ – [Numeric Calc] > [Absolute Value]
2 \ominus 7 EXE



The calculator display shows the function $|2-7|$ and the result 5.

(Input/Output: LineI/LineO)

☞ – [Numeric Calc] > [Absolute Value]
2 \ominus 7 ☉ EXE

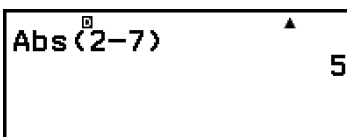

The calculator display shows the function $\text{Abs}(2-7)$ and the result 5.

Recurring Decimal

You can use \uparrow Ⓜ^2 ($\dot{\blacksquare}$) or the menu item below to input a recurring decimal.

Ⓜ – [Numeric Calc] > [Recurring Decimal]

For details, see "[Recurring Decimal Conversion \(Recurring Decimal Calculations\)](#)" (page 40).

Round Off

Using the Round Off function (Rnd) causes decimal fraction values of the argument to be rounded in accordance with the current Number Format setting. For example, the internal and displayed result of $\text{Rnd}(10 \div 3)$ is 3.333 when the Number Format setting is Fix 3. Using the Norm 1 or Norm 2 setting cause the argument to be rounded off at the 11th digit of the mantissa part.

Example: To perform the following calculations when Fix 3 is selected for the number of display digits: $10 \div 3 \times 3$ and $\text{Rnd}(10 \div 3) \times 3$
(Input/Output: MathI/DecimalO, Number Format: Fix 3)

$10 \div 3 \times 3 \text{ EXE}$



Calculator display showing the calculation $10 \div 3 \times 3$ resulting in 10.000. The display includes icons for square root, fraction, and decimal, and the text "FIX" indicating the number format.

Ⓜ – [Numeric Calc] > [Round Off]

$10 \div 3 \text{) } \times 3 \text{ EXE}$

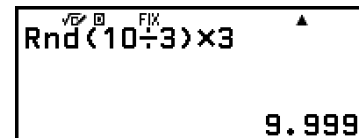

Calculator display showing the calculation $\text{Rnd}(10 \div 3) \times 3$ resulting in 9.999. The display includes icons for square root, fraction, and decimal, and the text "FIX" indicating the number format.

Angle Unit, Polar/Rectangular Coordinate, Sexagesimal

This section explains commands, functions, and symbols that you can input after performing the operation: Ⓜ – [Angle/Coord/Sexa].

Degrees, Radians, Gradians

These functions specify the angle unit.

$^{\circ}$ specifies degree, $^{\text{r}}$ radian, and $^{\text{g}}$ gradian.

You can input each function using the menu items below.

Ⓜ – [Angle/Coord/Sexa] > [Degrees]

Ⓜ – [Angle/Coord/Sexa] > [Radians]

Ⓜ – [Angle/Coord/Sexa] > [Gradians]

Example: $\pi/2$ radians = 90° (Angle Unit: Degree)

$\sin 30$ \rightarrow EXE

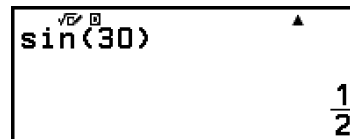

Others

Functions and symbols that can be input with the calculator keys can also be input using the [Other] menu. Use [Other] – [Other] to display the function and symbol menu. For example, to input Ans, you could either press [Ans] or perform the following operation: [Other] – [Other] > [Ans].

The table below shows the [Other] menu item that corresponds to each key operation.

Menu Item		Key
Ans		[Ans]
π		$\text{[Up Arrow]} \text{[7]} (\pi)$
e		$\text{[Up Arrow]} \text{[8]} (e)$
$\sqrt{\quad}$		[Square Root]
$x\sqrt{\quad}$		$\text{[Up Arrow]} \text{[Square Root]} \text{[Square Root]}$
-1	*1	$\text{[Up Arrow]} \text{[Square Root]} \text{[Square Root]}$
2	*2	[Square]
$\wedge(\quad)$		[Square]
-	*3	$\text{[Up Arrow]} \text{[Minus]} ((-))$
,		$\text{[Up Arrow]} \text{[Comma]} (,)$
([Left Bracket]
)		[Right Bracket]

*1 Reciprocal

*2 Square

*3 Minus sign

Registering and Using Defining Equations for $f(x)$ and $g(x)$

Registering and Using Defining Equations for $f(x)$ and $g(x)$

Your calculator includes "f(" and "g(" functions that you can use after registering defining equations for them. For example, after registering $f(x) = x^2 + 1$ as a defining equation for the "f(" function, you can calculate $f(0) = 1$ and $f(5) = 26$.

Pressing $\text{f}(x)$ displays a menu for registering the defining equation of $f(x)$ or $g(x)$, and for inputting "f(" or "g(".



Note

- The defining equations of $f(x)$ and $g(x)$ are also used by $f(x)$ and $g(x)$ in the Table app. For information about the Table app, see ["Creating a Number Table" \(page 74\)](#).

Registering a Defining Equation

Example 1: To register $f(x) = x^2 + 1$

1. Press CALC , select the Calculate app icon, and then press OK .
2. Press $\text{f}(x)$, and then select [Define $f(x)$].
 - This displays the $f(x)$ equation registration screen.

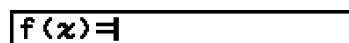

3. Input $x^2 + 1$.

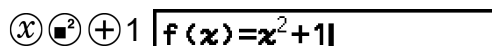

4. Press EXE .
 - This registers the expression you input, and the screen that was shown before you pressed $\text{f}(x)$ in step 2 of this procedure re-appears.

Note

- A defining equation can be registered from any calculator app except Ratio and Math Box. However, depending on the screen displayed by the calculator app (for example, if a menu screen is displayed), the menu may not appear when you press $\text{f}(x)$.

Performing a Calculation by Assigning a Value to the Registered Defining Equation

Example 2: To assign the value $x = 3$ to $f(x)$, which you registered in Example 1

(Continuing from Example 1)

- Press $\text{f}(x)$, and then select $[f(x)]$.
 - This inputs "f(".

f (

- Assign a value of 3 and then execute the calculation.

3) EXE

f (3) EXE

10

Registering a Composite Function

Example 3: To insert $f(x)$ defined in Example 1 into $g(x)$ in order to register $g(x) = f(x) \times 2 - x$

(Continuing from Example 1)

- Press $\text{f}(x)$, and then select $[Define\ g(x)]$.
 - This displays the $g(x)$ equation registration screen.

g (x) =

- Input $f(x) \times 2 - x$.

$\text{f}(x)$ * EXE (x)) \times 2 - (x) g (x) = f (x) \times 2 - x

- * Pressing $\text{f}(x)$ while the $g(x)$ equation registration screen is displayed, the only menu item that appears is $[f(x)]$. In the same way, pressing $\text{f}(x)$ while the $f(x)$ equation registration screen is displayed, the only menu item that appears is $[g(x)]$.

- Press EXE .
 - This registers the equation you input and returns to the screen displayed before you started this operation with step 1.



Note

- The operation for assigning a value to x of $g(x)$ and calculating the result is the same as that under "[Performing a Calculation by Assigning a Value to the Registered Defining Equation](#)" (page 54). However, note that instead of selecting $[f(x)]$ in step 1, you should select $[g(x)]$.
- In the operation of Example 3, you input $f(x)$ into the defining equation of $g(x)$. Conversely, you can also input $g(x)$ into the $f(x)$ defining equation. However, do not

have $g(x)$ input into $f(x)$, and $f(x)$ input into $g(x)$ at the same time. If you do, a Circular ERROR will occur when you perform a calculation using $f(x)$ or $g(x)$.

Data Retention

Performing any one of the operations below causes the defining equations registered to $f(x)$ and $g(x)$ to be deleted.

- Pressing 
- Using the SETTINGS menu to switch the Input/Output setting between MathI*¹ and LineI*².
 - *¹ MathI/MathO or MathI/DecimalO
 - *² LineI/LineO or LineI/DecimalO
- Executing  – [Reset] > [Settings & Data] or  – [Reset] > [Initialize All]

Using QR Code Functions

Using QR Code Functions

Your calculator can display QR Code symbols that can be read by a smart device.

Important!

- The operations in this section assume that the smart device being used has a QR Code reader that can read multiple QR Code symbols, and it can connect to the Internet.
- Scanning a QR Code displayed by this calculator with a smart device will cause the smart device to access the CASIO website.

Note

- QR Code appears on the display whenever you press \uparrow (X) (QR) while any one of the screens below is displayed.
 - HOME screen
 - SETTINGS menu screen
 - Error screens
 - Calculation result screens in any calculator app
 - Table screens in any calculator app
- For details, visit the CASIO website (<https://wes.casio.com>).

Displaying a QR Code

Example: To display the QR Code for a calculation result in the calculator's Calculate app and scan it with a smart device

1. In the Calculate app, perform some calculation.
2. Press \uparrow (X) (QR) to display the QR Code.
 - The numbers in the lower right corner of the display show the current QR Code number and the total number of QR Code symbols. To display the next QR Code, press \vee or OK .

Note

- To return to a previous QR Code, press \vee or OK as many times as required to scroll forward until it appears.

3. Use a smart device to scan the QR Code on the calculator display.
 - For information about how to scan a QR Code, refer to the user documentation of the QR Code reader you are using.

If You Experience Difficulty Scanning a QR Code

While the QR Code is displayed, use ⏪ and ⏩ to adjust the display contrast of the QR Code. This contrast adjustment affects QR Code displays only.

Important!

- Depending on the smart device and/or QR Code reader app being used, you may experience problems scanning the QR Code symbols produced by this calculator.
- When the "QR Code" setting on the SETTINGS menu is "Version 3", the calculator apps that can display QR Code symbols are limited. If you try to display a QR Code in an app that does not support QR Code display, the message "Not Supported (Version 3)" will appear. However, the QR Code produced by this setting is easier to scan with a smart device.
- For more information, visit the CASIO website (<https://wes.casio.com>).

Using Calculator Apps

Statistical Calculations

The Statistics app calculates various statistical values based on single-variable (x) or paired-variable (x, y) data.

General Procedure for Performing a Statistical Calculation

1. Press 2ND , select the Statistics app icon, and then press OK .
2. On the menu that appears, select [1-Variable] (single-variable) or [2-Variable] (paired-variable), and then press OK .
 - This displays the Statistics Editor.

	x	Freq
1		
2		
3		
4		

Single-variable

	x	y	Freq
1			
2			
3			
4			

Paired-variable

- You can use the Freq column to specify the frequency of each sample value. For details, see ["Freq \(Frequency\) Column" \(page 59\)](#).
3. Input data.
 - For details, see ["Inputting Data with Statistics Editor" \(page 59\)](#).
 4. After you finish inputting data, press OK .
 - This causes the menu below to appear.

1-Var Results
Statistics Calc

Single-variable



Paired-variable

5. Select the menu item for the operation you want to perform.
 - Select [1-Var Results], [2-Var Results], or [Reg Results] to see a list of calculation results based on the data you entered. For details, see ["Displaying Statistical Calculation Results" \(page 62\)](#).
 - To display a statistical calculation screen for performing calculations based on the input data, select [Statistics Calc]. For details, see ["Using Statistical Calculation Screen" \(page 66\)](#).

Note

- To return to the Statistics Editor from a statistical calculation screen, press AC and then ↩ .

Inputting Data with Statistics Editor

Statistics Editor displays one, two, or three columns: single-variable (x), single-variable and frequency (x , Freq), paired-variable (x , y), paired-variable and frequency (x , y , Freq). The number of data rows that can be input depends on the number of columns: 160 rows for one column, 80 rows for two columns, 53 rows for three columns.

Important!

- All data currently input in the Statistics Editor is deleted whenever you perform any of the operations below.
 - Switching the statistical calculation type between single-variable and paired-variable
 - Changing the Frequency setting on the TOOLS menu
- Statistical calculations can take considerable time when there are a large number of data items.

Freq (Frequency) Column

When the Frequency setting on the TOOLS menu is turned on, a column labeled "Freq" will be included on the Statistics Editor. You can use the Freq column to specify the frequency (the number of times the same sample appears in the data group) of each sample value.

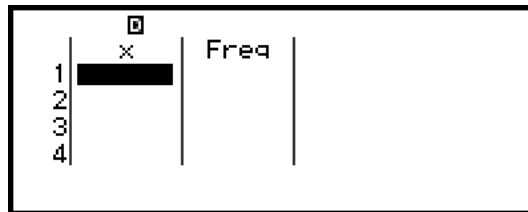

Single-variable

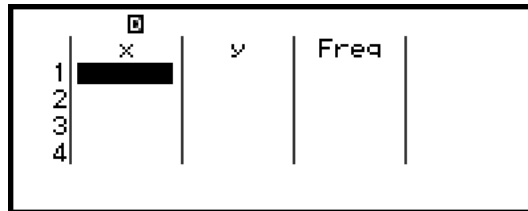

Paired-variable

To hide the Freq column

1. While the Statistics Editor is displayed, press \odot and then select [Frequency] > [Off].
2. Press AC to return to the Statistics Editor.

To display the Freq column

1. While the Statistics Editor is displayed, press \odot and then select [Frequency] > [On].
2. Press AC to return to the Statistics Editor.

Rules for Inputting Sample Data on the Statistics Editor

Data you input is inserted into the cell where the cursor is located. Use the cursor keys to move the cursor between cells.

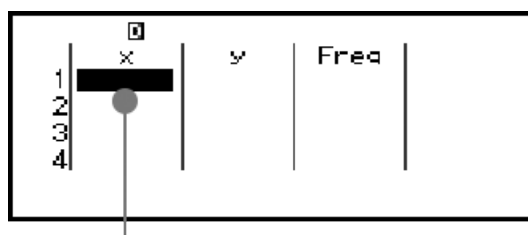

Cursor

After inputting a value, press EXE . This registers the value and displays up to six of its digits in the cell.

Example 1: To select paired-variable and input the following data: (170, 66), (179, 75), (173, 68)

1. Press STAT , select the Statistics app icon, and then press OK .
2. Select [2-Variable], and then press OK .

	x	y	Freq
1			
2			
3			
4			

3. Use the operation below to input data.

170 $\text{\textcircled{EXE}}$ 179 $\text{\textcircled{EXE}}$ 173 $\text{\textcircled{EXE}}$ $\text{\textcircled{V}}$ $\text{\textcircled{>}}$
 66 $\text{\textcircled{EXE}}$ 75 $\text{\textcircled{EXE}}$ 68 $\text{\textcircled{EXE}}$

	x	y	Freq
1	170	66	1
2	179	75	1
3	173	68	1
4			

Note

- On the Statistics Editor, you can store the value in a cell to a variable. For example, performing the following operation while the screen in step 3 is displayed above will store 68 to variable A: $\text{\textcircled{^}} \text{\textcircled{2}} \text{\textcircled{3}} - [A=] > [\text{Store}]$. For details about variables, see "[Variables \(A, B, C, D, E, F, x, y, z\)](#)" (page 34).

Editing Sample Data

To replace the data in a cell

On the Statistics Editor, move the cursor to the cell containing the data you want to edit, input the new data, and then press $\text{\textcircled{EXE}}$.

To delete a row

On the Statistics Editor, move the cursor to the row you want to delete and then press $\text{\textcircled{X}}$.

To insert a row

- On the Statistics Editor, move the cursor to the row that will be under the row you will insert.
- Perform the following operation: $\text{\textcircled{000}} - [\text{Edit}] > [\text{Insert Row}]$.

To delete all Statistics Editor contents

On the Statistics Editor, perform the following operation: $\text{\textcircled{000}} - [\text{Edit}] > [\text{Delete All}]$.

Sorting Data

You can sort Statistics Editor data in ascending or descending order on its x , y , or Freq-column values.

Important!

- Note that after you change the data sort sequence, you will not be able to return it to its original sequence.

Example 2: To sort the data input in **Example 1 (page 60)** in ascending order on the x column, and then in descending order on the y column

1. Use the procedure in Example 1 to input the data.

	x	y	Freq
1	170	66	1
2	173	75	1
3	173	68	1
4			

2. Sort the data in ascending order on the x column.

\odot – [Sort] > [x Ascending]

	x	y	Freq
1	170	66	1
2	173	68	1
3	173	75	1
4			

170

3. Sort the data in descending order on the y column.

\odot – [Sort] > [y Descending]

	x	y	Freq
1	179	75	1
2	173	68	1
3	170	66	1
4			

75

Displaying Statistical Calculation Results

Displaying Single-Variable Statistical Calculation Results

The 1-Var Results screen shows a list of various statistical values (such as mean and population standard deviation) calculated based on single-variable data. This section describes the operation required to display the 1-Var Results screen.

Example 3: To input the data below and display single-variable statistical calculation results

x	1	2	3	4	5	6	7	8	9	10
Freq	1	2	1	2	2	2	3	4	2	1

1. Press \odot , select the Statistics app icon, and then press OK .

2. Select [1-Variable], and then press OK .

- This displays the Statistics Editor.

3. Input data into the x -column.

1 EXE 2 EXE 3 EXE 4 EXE 5 EXE 6 EXE 7 EXE 8 EXE 9 EXE 10 EXE

	x	Freq
8	9.8	1
9	10	1
10		
11		

4. Input data into the Freq column.

∇ \triangleright ∇ 2 EXE ∇ 2 EXE 2 EXE 2 EXE 3 EXE 4 EXE 2 EXE

	\square		
7	x	7	Freq
8		8	3
9		9	4
10		10	2

5. Press OK .

1-Var Results
Statistics Calc

6. Select [1-Var Results], and then press OK .

- This displays the 1-Var Results screen.

\square	
\bar{x}	=5.95
Σx	=119
Σx^2	=837
$\sigma^2 x$	=6.4475
σx	=2.539192785
$s^2 x$	=6.786842105

∇ (or ∇)

\square	
s_x	=2.605156829
n	=20
min(x)	=1
Q1	=4
Med	=6.5
Qs	=8

∇ (or ∇)

\square	
max(x)	=10

- For the meanings of the variables shown on the 1-Var Results screen, see the ["List of Statistical Value Variables and Statistical Calculation Functions"](#) (page 69).

7. Press 2nd or AC to return to the Statistics Editor.

Displaying Paired-Variable Statistical Calculation Results

The 2-Var Results screen shows a list of various statistical values (such as mean and population standard deviation) calculated based on paired-variable data. This section describes the operation required to display the 2-Var Results screen.

Example 4: To input the data below and display paired-variable statistical calculation results

x	1.0	1.2	1.5	1.6	1.9	2.1	2.4	2.5	2.7	3.0
y	1.0	1.1	1.2	1.3	1.4	1.5	1.6	1.7	1.8	2.0

- Press 2nd , select the Statistics app icon, and then press OK .
- Select [2-Variable], and then press OK .
 - This displays the Statistics Editor.
- Press 2nd and then select [Frequency] > [Off].

- Press AC to return to the Statistics Editor.

4. Input data into the x -column.

1 EXE 1 EXE 2 EXE 1 EXE 5 EXE 1 EXE 6 EXE 1 EXE 9 EXE
 2 EXE 1 EXE 2 EXE 4 EXE 2 EXE 5 EXE 2 EXE 7 EXE 3 EXE

	x	y
8	2.5	0
9	2.7	0
10	3	0
11		

5. Input data into the y -column.

V > 1 EXE 1 EXE 1 EXE 2 EXE 1 EXE 3 EXE 1 EXE 4 EXE
 1 EXE 5 EXE 1 EXE 6 EXE 1 EXE 7 EXE 1 EXE 8 EXE 2 EXE

	x	y
8	2.5	1.7
9	2.7	1.8
10	3	2
11		

6. Press OK .

2-Var Results
Reg Results \blacktriangleright
Statistics Calc \blacktriangleright

7. Select [2-Var Results], and then press OK .

- This displays the 2-Var Results screen.

Σx	=1.99
Σy	=19.9
Σx^2	=43.57
Σy^2	=0.3969
σx	=0.63
$s^2 x$	=0.441

V (or V)

$s x$	=0.6640783086
n	=10
\bar{y}	=1.46
Σy	=14.6
Σy^2	=22.24
$\sigma^2 y$	=0.0924

V (or V)

σy	=0.3039736831
$s^2 y$	=0.1026666667
$s y$	=0.3204163958
Σxy	=30.96
Σx^3	=102.451
$\Sigma x^2 y$	=71.244

V (or V)

Σx^4	=253.5541
$\text{min}(x)$	=1
$\text{max}(x)$	=3
$\text{min}(y)$	=1
$\text{max}(y)$	=2

- For the meanings of the variables shown on the 2-Var Results screen, see the "[List of Statistical Value Variables and Statistical Calculation Functions](#)" (page 69).

8. Press 2nd or AC to return to the Statistics Editor.

Displaying Regression Calculation Results

The Reg Results screen displays a list of regression calculation results (coefficients of regression equations) based on paired-variable data. This

section describes the operation required to display the Reg Results screen.

Example 5: To use the paired-variable data input in [Example 4 \(page 63\)](#) and display the results of the two regression calculations shown below

- The regression equation " $y = a + bx$ " coefficients (a , b), and the correlation coefficient (r) when linear regression is performed on the data
- The regression equation " $y = a + bx + cx^2$ " coefficients (a , b , c) when quadratic regression is performed on the data

Note

- For information about regression calculation types supported by the Statistics app, see the ["Supported Regression Type List" \(page 66\)](#).

1. Perform steps 1 through 6 of the procedure under [Example 4 \(page 63\)](#).
2. Select [Reg Results], and then press **OK**.
 - This displays the regression type menu.

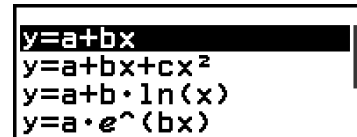

```
y=a+bx
y=a+bx+cx^2
y=a+b*ln(x)
y=a*e^(bx)
```

3. Select [$y=a+bx$], and then press **OK**.
 - This displays the linear regression Reg Results screen.

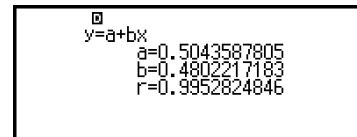

```
y=a+bx
a=0.5043587805
b=0.4802217183
r=0.9952824846
```

4. Press **↵** or **AC** to return to the Statistics Editor.
5. Press **OK**, and then select [Reg Results] > [$y=a+bx+cx^2$].
 - This displays quadratic regression Reg Results screen.

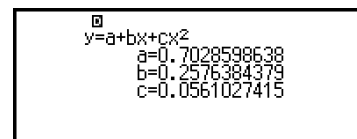

```
y=a+bx+cx^2
a=0.7028598638
b=0.2576384379
c=0.0561027415
```

6. Press **↵** or **AC** to return to the Statistics Editor.
 - For the meanings of the variables shown on the Reg Results screen, see the ["List of Statistical Value Variables and Statistical Calculation Functions" \(page 69\)](#).

Supported Regression Type List

Regression Type	Regression Equation (regression type menu item)
Linear Regression	$y = a + bx$
Quadratic Regression	$y = a + bx + cx^2$
Logarithmic Regression	$y = a + b \cdot \ln(x)$
<i>e</i> exponential Regression	$y = a \cdot e^{(bx)}$
<i>ab</i> exponential Regression	$y = a \cdot b^x$
Power Regression	$y = a \cdot x^b$
Inverse Regression	$y = a + b/x$

Using Statistical Calculation Screen

You can use the statistical calculation screen to recall individual statistical values and use the values in calculations.



Screen without calculation expression input

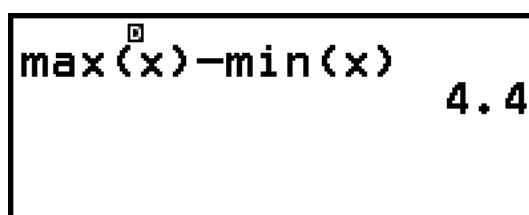

Example calculation

To recall a statistical value, use a variable representing the statistical value you want to recall (for example, \bar{x} , x population standard deviation: σ_x , x maximum value: $\max(x)$, and so on). For more information about these variables, see the ["List of Statistical Value Variables and Statistical Calculation Functions"](#) (page 69).

Displaying a Statistical Calculation Screen

Single-variable

1. While the Statistics Editor is displayed, press OK .
2. On the menu that appears, select [Statistics Calc] and then press OK .



Paired-variable

1. While the Statistics Editor is displayed, press OK .
2. On the menu that appears, select [Statistics Calc] and then press OK .
 - This displays the regression type menu (see the "[Supported Regression Type List](#)" (page 66)).

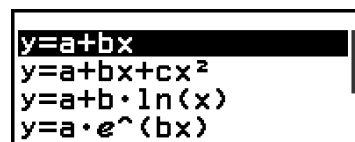

3. On the menu, select the regression type you want and then press OK .



- In the example above, use the displayed menu to select [$y=a+bx$] (Linear regression).

To return to the Statistics Editor from a statistical calculation screen

Press AC , and then D .

Calculation Example Using the Statistical Calculation Screen

Example 6: To determine the sum of the sample data (Σx) and mean (\bar{x}) of the single-variable data input in [Example 3 \(page 62\)](#)

1. Perform steps 1 through 6 of the procedure under [Example 3 \(page 62\)](#).
2. Select [Statistics Calc], and then press OK .



3. Calculate the sum of the sample data (Σx).

$\text{2nd} - [\text{Statistics}] > [\text{Summation}] > [\Sigma x]$

4. Calculate the mean (\bar{x}).

$\text{2nd} - [\text{Statistics}] > [\text{Mean/Var/Dev}\dots] > [\bar{x}]$

Note

- To display the 1-Var Results screen from the statistical calculation screen above, press 2nd and then select [1-Var Results]. To return to the statistical calculation screen from the 1-Var Results screen, press left arrow or AC .

Example 7: To determine the coefficients (a , b) and correlation coefficient (r) of the linear regression equation " $y = a + bx$ " based on the paired-variable data input in [Example 4 \(page 63\)](#)

- Perform steps 1 through 6 of the procedure under [Example 4 \(page 63\)](#).
- Select [Statistics Calc], and then press OK .
 - This displays the regression type menu.

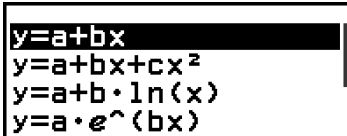

- Select [$y=a+bx$], and then press OK .

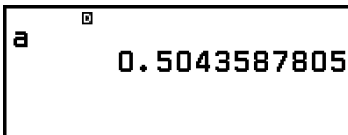

- Determine the coefficients (a , b) and correlation coefficient (r) of the regression equation " $y = a + bx$ ".

$\text{2nd} - [\text{Statistics}] > [\text{Regression}] > [a]$

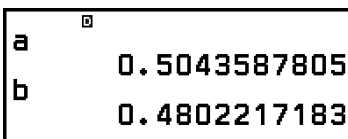
$\text{2nd} - [\text{Statistics}] > [\text{Regression}] > [b]$

\square – [Statistics] > [Regression] > [r]

\square

b	0.4802217183
r	0.9952824846

- To select a different regression type, press \square and then select [Select Reg Type]. This displays the regression type menu from step 2.

To display the 2-Var Results screen from a statistical calculation screen

Press \square and then select [2-Var Results].

To display the Reg Results screen from a statistical calculation screen

Press \square and then select [Reg Results].

List of Statistical Value Variables and Statistical Calculation Functions

You can use the CATALOG menu to recall variables representing statistical values and functions used for statistical calculations.

Note

- For single-variable statistical calculations, the variables marked with an asterisk (*) are available.
- For the calculation formula used for each variable and command, see "[Statistical Calculation Formula](#)" (page 71).

\square – [Statistics] > [Summation]

- Σx^* , Σy sum of the sample data
- Σx^{2*} , Σy^2 sum of squares of the sample data
- Σxy sum of products of the x -data and y -data
- Σx^3 sum of cubes of the x -data
- Σx^2y sum of (x -data squares \times y -data)
- Σx^4 sum of biquadrate of the x -data

\square – [Statistics] > [Mean/Var/Dev...]

- \bar{x}^* , \bar{y} mean
- σ_x^2 , σ_y^2 population variance
- σ_x , σ_y population standard deviation
- s_x^2 , s_y^2 sample variance
- s_x , s_y sample standard deviation
- n^* number of items

\square – [Statistics] > [Min/Max/Quartile] (Single-Variable Data Only)

$\min(x)^*$ minimum value
 Q_1^* first quartile
 Med^* median
 Q_3^* third quartile
 $\max(x)^*$ maximum value

☞ – **[Statistics] > [Min/Max]** (Paired-Variable Data Only)

$\min(x), \min(y)$ minimum value
 $\max(x), \max(y)$ maximum value

☞ – **[Statistics] > [Regression]** (Paired-Variable Data Only)

For quadratic regression

a, b, c regression coefficients for quadratic regression
 \hat{x}_1, \hat{x}_2 Functions for determining x_1 and x_2 estimated values for an input y -value. For the argument, input the value of y immediately before the \hat{x}_1 or \hat{x}_2 function.
 \hat{y} Function for determining the y estimated value for an input x -value. For the argument, input the value of x immediately before this function.

For non-quadratic regression

a, b regression coefficients
 r correlation coefficient
 \hat{x} Function for determining x estimated value for an input y -value. For the argument, input the value of y immediately before this function.
 \hat{y} Function for determining the y estimated value for an input x -value. For the argument, input the value of x immediately before this function.

For an example of the operation to determine estimated values, see ["Calculating Estimated Values \(Paired-Variable Data Only\)" \(page 70\)](#).

Calculating Estimated Values (Paired-Variable Data Only)

Based on the regression equation obtained by paired-variable statistical calculation, the estimated value of y can be calculated for a given x -value. The corresponding x -value (two values, x_1 and x_2 , in the case of quadratic regression) also can be calculated for a value of y in the regression equation.

Example 8: To determine the estimated value for y when $x = 5.5$ in the regression equation produced by linear regression of the data input in [Example 4 \(page 63\)](#)

1. Perform steps 1 through 6 of the procedure under [Example 4 \(page 63\)](#).
2. Select [Statistics Calc], and then press OK .
 - This displays the regression type menu.

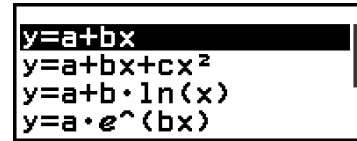

3. Select [$y=a+bx$], and then press OK .



4. Input the x -value (5.5), and then input " \hat{y} ", which is the function to determine the estimated value of y .

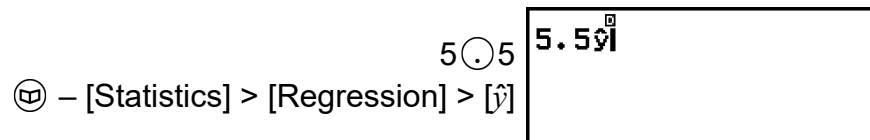

5. Press EXE .

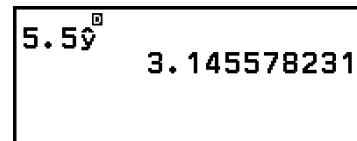

Statistical Calculation Formula

Single-Variable Statistical Calculation Formula

$$\bar{x} = \frac{\sum x}{n}$$

$$\sigma_x = \sqrt{\frac{\sum (x - \bar{x})^2}{n}}$$

$$s_x = \sqrt{\frac{\sum (x - \bar{x})^2}{n - 1}}$$

Paired-Variable Statistical Calculation Formula

$$\bar{x} = \frac{\sum x}{n}$$

$$\sigma_x = \sqrt{\frac{\sum (x - \bar{x})^2}{n}}$$

$$s_x = \sqrt{\frac{\sum (x - \bar{x})^2}{n - 1}}$$

$$\bar{y} = \frac{\sum y}{n}$$

$$\sigma_y = \sqrt{\frac{\sum (y - \bar{y})^2}{n}}$$

$$s_y = \sqrt{\frac{\sum (y - \bar{y})^2}{n - 1}}$$

Regression Calculation Formula

Linear Regression ($y = a + bx$)

$$a = \frac{\sum y - b \cdot \sum x}{n}$$

$$b = \frac{n \cdot \sum xy - \sum x \cdot \sum y}{n \cdot \sum x^2 - (\sum x)^2}$$

$$r = \frac{n \cdot \sum xy - \sum x \cdot \sum y}{\sqrt{\{n \cdot \sum x^2 - (\sum x)^2\} \{n \cdot \sum y^2 - (\sum y)^2\}}}$$

$$\hat{x} = \frac{y - a}{b}$$

$$\hat{y} = a + bx$$

Quadratic Regression ($y = a + bx + cx^2$)

$$a = \frac{\sum y}{n} - b \left(\frac{\sum x}{n} \right) - c \left(\frac{\sum x^2}{n} \right)$$

$$b = \frac{S_{xy} \cdot S_{x^2 x^2} - S_{x^2 y} \cdot S_{xx^2}}{S_{xx} \cdot S_{x^2 x^2} - (S_{xx^2})^2}$$

$$c = \frac{S_{x^2 y} \cdot S_{xx} - S_{xy} \cdot S_{xx^2}}{S_{xx} \cdot S_{x^2 x^2} - (S_{xx^2})^2}$$

$$S_{xx} = \sum x^2 - \frac{(\sum x)^2}{n}$$

$$S_{xy} = \sum xy - \frac{(\sum x \cdot \sum y)}{n}$$

$$S_{xx^2} = \sum x^3 - \frac{(\sum x \cdot \sum x^2)}{n}$$

$$S_{x^2 x^2} = \sum x^4 - \frac{(\sum x^2)^2}{n}$$

$$S_{x^2 y} = \sum x^2 y - \frac{(\sum x^2 \cdot \sum y)}{n}$$

$$\hat{x}_1 = \frac{-b + \sqrt{b^2 - 4c(a - y)}}{2c}$$

$$\hat{x}_2 = \frac{-b - \sqrt{b^2 - 4c(a - y)}}{2c}$$

$$\hat{y} = a + bx + cx^2$$

Logarithmic Regression ($y = a + b \cdot \ln(x)$)

$$a = \frac{\sum y - b \cdot \sum \ln x}{n}$$

$$b = \frac{n \cdot \sum(\ln x)y - \sum \ln x \cdot \sum y}{n \cdot \sum(\ln x)^2 - (\sum \ln x)^2}$$

$$r = \frac{n \cdot \sum(\ln x)y - \sum \ln x \cdot \sum y}{\sqrt{\{n \cdot \sum(\ln x)^2 - (\sum \ln x)^2\} \{n \cdot \sum y^2 - (\sum y)^2\}}}$$

$$\hat{x} = e^{\frac{y-a}{b}}$$

$$\hat{y} = a + b \ln x$$

e Exponential Regression ($y = a \cdot e^{(bx)}$)

$$a = \exp\left(\frac{\sum \ln y - b \cdot \sum x}{n}\right)$$

$$b = \frac{n \cdot \sum x \ln y - \sum x \cdot \sum \ln y}{n \cdot \sum x^2 - (\sum x)^2}$$

$$r = \frac{n \cdot \sum x \ln y - \sum x \cdot \sum \ln y}{\sqrt{\{n \cdot \sum x^2 - (\sum x)^2\} \{n \cdot \sum (\ln y)^2 - (\sum \ln y)^2\}}}$$

$$\hat{x} = \frac{\ln y - \ln a}{b}$$

$$\hat{y} = a e^{bx}$$

ab Exponential Regression ($y = a \cdot b^x$)

$$a = \exp\left(\frac{\sum \ln y - \ln b \cdot \sum x}{n}\right)$$

$$b = \exp\left(\frac{n \cdot \sum x \ln y - \sum x \cdot \sum \ln y}{n \cdot \sum x^2 - (\sum x)^2}\right)$$

$$r = \frac{n \cdot \sum x \ln y - \sum x \cdot \sum \ln y}{\sqrt{\{n \cdot \sum x^2 - (\sum x)^2\} \{n \cdot \sum (\ln y)^2 - (\sum \ln y)^2\}}}$$

$$\hat{x} = \frac{\ln y - \ln a}{\ln b}$$

$$\hat{y} = a b^x$$

Power Regression ($y = a \cdot x^b$)

$$a = \exp\left(\frac{\sum \ln y - b \cdot \sum \ln x}{n}\right)$$

$$b = \frac{n \cdot \sum \ln x \ln y - \sum \ln x \cdot \sum \ln y}{n \cdot \sum (\ln x)^2 - (\sum \ln x)^2}$$

$$r = \frac{n \cdot \sum \ln x \ln y - \sum \ln x \cdot \sum \ln y}{\sqrt{\{n \cdot \sum (\ln x)^2 - (\sum \ln x)^2\} \{n \cdot \sum (\ln y)^2 - (\sum \ln y)^2\}}}$$

$$\hat{x} = e^{\frac{\ln y - \ln a}{b}}$$

$$\hat{y} = a x^b$$

Inverse Regression ($y = a + b/x$)

$$a = \frac{\sum y - b \cdot \sum x^{-1}}{n}$$

$$b = \frac{S_{xy}}{S_{xx}}$$

$$r = \frac{S_{xy}}{\sqrt{S_{xx} \cdot S_{yy}}}$$

$$S_{xx} = \Sigma(x^{-1})^2 - \frac{(\Sigma x^{-1})^2}{n}$$

$$S_{yy} = \Sigma y^2 - \frac{(\Sigma y)^2}{n}$$

$$S_{xy} = \Sigma(x^{-1})y - \frac{\Sigma x^{-1} \cdot \Sigma y}{n}$$

$$\hat{x} = \frac{b}{y - a}$$

$$\hat{y} = a + \frac{b}{x}$$

Creating a Number Table

You can use the Table app to create a number table based on the defining equations registered for functions $f(x)$ and $g(x)$.

General Procedure for Creating a Number Table

Example : To generate a number table for the function $f(x) = x^2 + \frac{1}{2}$ for the range $-1 \leq x \leq 1$, incremented in steps of 0.5

1. Press \odot , select the Table app icon, and then press OK .
 - This displays the number table screen.
 - If a defining equation is not registered for either or both of $f(x)$ and $g(x)$ and the data at the cursor selection position is empty, a message will appear at the bottom of the screen indicating that the defining equation is not registered.

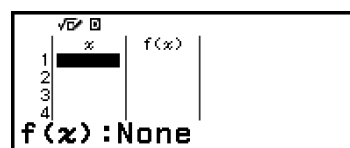

2. Configure settings to generate a number table from the function.
 - (1) Press \odot , and then select [Table Type] > [f(x)].
 - (2) Press AC .
 - For information about settings, see "[Maximum Number of Rows in a Number Table According to Table Type](#)" (page 75).
3. Register a defining equation for $f(x)$.

\odot – [Define f(x)/g(x)] > [Define f(x)] $f(x) = x^2 + \frac{1}{2}$

X M^2 + 1 = 2 EXE

(Screen immediately before you pressed EXE)

- You can also use $\text{f}\omega$ to register a defining expression. For more information, see ["Defining Equation Registration" \(page 76\)](#).

4. Configure the number table range setting.



5. Press EXE .

- This displays the result in the number table screen.

x	f(x)
1	1.5
-0.5	0.75
0	0.5
0.5	0.75

-1

- The number table generation operation causes the contents of variable x to be changed.

Note

- On the number table screen, you can store the value in a cell to a variable. For example, performing the following operation while the screen in step 6 is displayed above will store -1 to variable A: $\text{(-1)} \rightarrow [A] > [\text{Store}]$. For details about variables, see ["Variables \(A, B, C, D, E, F, x, y, z\)" \(page 34\)](#).

Maximum Number of Rows in a Number Table According to Table Type

You can configure number table screen settings to show columns for both $f(x)$ and $g(x)$, or for either one of them. To set it, use the menu that appears when you press $\text{f}\omega$ - [Table Type] while the number table screen is displayed.

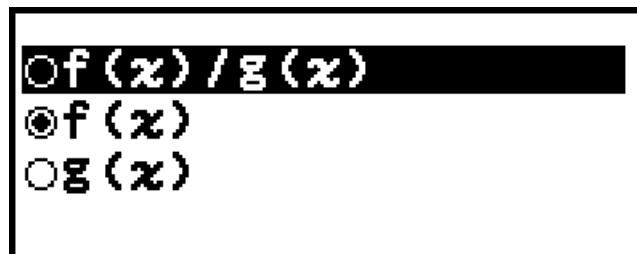

$f(x)/g(x)$... Show both $f(x)$ - and $g(x)$ -columns

$f(x)$... Show only $f(x)$ -column (initial default setting)

$g(x)$... Show only $g(x)$ -column

The maximum number of rows in the generated number table depends on the Table Type setting. Up to 45 rows are supported for the " $f(x)$ " or " $g(x)$ " setting, while 30 rows are supported for the " $f(x)/g(x)$ " setting.

Defining Equation Registration

There are two ways to register defining equations for $f(x)$ and $g(x)$.

- While the Table app number table screen is displayed, registering an equation by pressing $\odot\odot\odot$
 - $\odot\odot\odot$ – [Define $f(x)/g(x)$] > [Define $f(x)$]
 - $\odot\odot\odot$ – [Define $f(x)/g(x)$] > [Define $g(x)$]
- While the Table app number table screen is displayed, or while using any calculator app except Ratio and Math Box, registering an equation by pressing $\odot f(x)$
 - $\odot f(x)$ – [Define $f(x)$]
 - $\odot f(x)$ – [Define $g(x)$]

The same $f(x)$ or $g(x)$ equation registration screen appears regardless of which of the two above operations is used to register defining equations.

Note

- For details about operations using $\odot f(x)$, see "[Registering and Using Defining Equations for \$f\(x\)\$ and \$g\(x\)\$](#) " (page 53).

Editing Number Table Screen Data

To delete a row

1. On the number table screen, move the cursor to the row you want to delete.
2. Press \odot .

To insert a row

1. On the number table screen, move the cursor to the row that will be under the row you will insert.
2. Perform the following operation: $\odot\odot\odot$ – [Edit] > [Insert Row].

To delete all number table screen contents

On the number table screen, perform the following operation: $\odot\odot\odot$ – [Edit] > [Delete All].

To change the value input in a cell in column x

You can change the value in the currently highlighted x cell. Changing the x value causes the $f(x)$ and $g(x)$ values in the same row to be updated accordingly.

To enter a value into the highlighted x -column cell using: {value of the cell above} +/- {step value}

If there is value in the x cell above the currently highlighted x cell, pressing \oplus or EXE automatically inputs into the highlighted cell the value equal to the value of the cell above it plus the step value. So also, pressing \ominus automatically inputs the value equal to the value of the cell above less the step value. The $f(x)$ and $g(x)$ values in the same row are also updated accordingly.

$f(x)$ and $g(x)$ Update Timing

$f(x)$ and $g(x)$ values displayed on the number table screen are updated when any of the following occurs.

- When EXE is pressed while [Execute] is selected on the Table Range screen.
- When the defining equations for $f(x)$ and $g(x)$ are updated (except when a defining equation is a composite function).
- When a number is input into column x (including pressing \oplus , \ominus , EXE in column x).

Note, however, that values are not updated automatically after the following operations.

- When the SETTINGS menu is used to change the Angle Unit setting.
- When the variable of a defining equation is updated (new numeric value stored) when a defining equation that contains a variable (example: $f(x) = 2x + A$) is registered.
- When the defining equation of a composite function (Example: $g(x) = f(x) \times 2 - x$) is registered, and the defining equation of the reference function (Example: $f(x)$ or $g(x) = f(x) \times 2 - x$) is updated (new defining equation registered).

In these cases, execute CPL – [Recalculate] while the number table screen is displayed to update values.

Data Retention

Doing the following will discard some data and clear some settings of the Table app.

- ① Returning to the HOME screen and launching another calculator app.
- ② Pressing CPL .
- ③ Changing the Input/Output setting with the SETTINGS menu.
- ④ Changing the Table Type setting with the TOOLS menu.

The table below shows which data is discarded and which data is retained.

Operation Data, Setting	①	②	③	④
Number table data (x -, $f(x)$ -, $g(x)$ -columns)	Discarded	Discarded	Discarded	Discarded
Table Range settings	Discarded	Retained	Retained	Retained
Table Type settings	Retained	Retained	Retained	--
$f(x)$, $g(x)$ defining equations	Retained	Discarded	Discarded	Retained

Ratio Calculations

The Ratio app lets you determine the value of X in the ratio expression $A : B = X : D$ (or $A : B = C : X$) when the values of A , B , C and D are known.

General Procedure for Performing a Ratio Calculation

Example 1: To solve $3 : 8 = X : 12$ for X

- Press \odot , select the Ratio app icon, and then press OK .
- On the menu that appears, select $[A:B=X:D]$ or $[A:B=C:X]$.
 - Here we want to solve $3 : 8 = X : 12$ for X , select $[A:B=X:D]$, and then press OK .
- On the Coefficient Editor that appears, input coefficient values.
 - Here we input the following for the coefficients: $A = 3$, $B = 8$, $D = 12$.

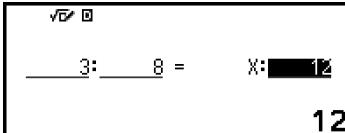
$$3 \text{EXE} 8 \text{EXE} 12 \text{EXE}$$

The screenshot shows a calculator interface with the text "3: 8 = X: 12" displayed. The numbers 3, 8, and 12 are entered into input fields, and the variable X is shown in a field with a cursor. The screen also displays "√E" at the top and "12" at the bottom right.

- After all the values are the way you want, press OK .
 - This displays the solution (value of X).



The screenshot shows the calculator interface displaying "X=" followed by the fraction $\frac{9}{2}$. The screen also displays "√E" at the top and $\frac{9}{2}$ at the bottom right.

- Press \odot , AC , or OK to return to the Coefficient Editor.

Note

- A Math ERROR will occur if you perform a calculation while 0 is input for a coefficient.
- Performing the steps below resets all Coefficient Editor coefficients to 1.
 - While the Coefficient Editor is displayed, press \odot , AC , \odot , or ON .
 - While a solution is displayed, press \odot or ON .

- You can store the currently displayed calculation result to a variable. For example, performing the following operation while the screen in step 4 is displayed above will store the calculation result to variable A: $\text{[Ratio]} \rightarrow [A] \rightarrow [Store]$. For details about variables, see ["Variables \(A, B, C, D, E, F, x, y, z\)" \(page 34\)](#).

To change the ratio expression type

- While the Coefficient Editor is displayed, press \odot .
- On the menu that appears, select the ratio expression type you want.

Calculation Example

Example 2: To calculate X in the ratio $1 : 2 = X : 10$

\odot – [Ratio] > [A:B=X:D]
 $1 \text{ [EXE]} 2 \text{ [EXE]} 10 \text{ [EXE]}$

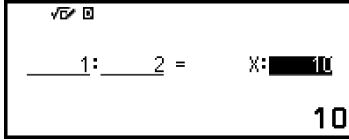

[EXE]



Using Math Box

The Math Box app has the following learning support functions.

Dice Roll: Dice Roll is function that simulates dice probability.

Coin Toss: Coin Toss is a function that simulates coin toss probability.

Number Line: Number Line registers up to three equations or inequalities and displays their number lines.

Circle: Circle uses a Unit Circle or Half Circle graphic to display angle and trigonometric values. You can also use a Clock graphic to display angles.

Dice Roll

Dice Roll performs a simulation of one, two, or three virtual dice rolls a specified number of times. You can select either of the following screens for the result.

	A	B	C	Sum
1	1	6	4	11
2	4	3	6	13
3	3	5	1	9
4	1	6	6	13

List screen

Sum	Freq	Rel Fr	Attempts
1	46	0.184	250
2	35	0.14	
3	31	0.124	
4	39	0.156	

0.184

Relative Freq screen

Dice Roll General Operation Procedure

Example: To simulate 100 rolls of two dice. For this example, the Relative Freq screen is used for simulation results, showing the number of occurrences (frequencies) and relative frequencies of the numeric difference (0, 1, 2, 3, 4, 5) between the two dice each roll.

1. Press \odot , select the Math Box app icon, and then press OK .
 - This displays the Math Box menu.

D	Dice Roll
C	Coin Toss
--	Number Line
+	Circle

2. Select [Dice Roll], and then press OK .
 - This displays the parameter input screen.

Dice	:1	\blacktriangleright
Attempts	:5	\blacktriangleright
Same Result	:Off	\blacktriangleright
E	Execute	

Dice: Select the number of dice as 1, 2, or 3.

Attempts: Input the number of dice rolls (number of trials) as a value from 1 to 250.

Same Result: This setting is normally Off (initial default setting). For details, see "[Same Result Setting](#)" (page 83).

3. Select each of the menu settings and configure them the way you want.
 - (1) Select [Dice] and then press OK . On the menu that appears, select [2 Dice] and then press OK .
 - (2) Select [Attempts] and then press OK . On the input screen that appears, input 100 and then press OK . Select [Confirm] and then press OK .
 - (3) Leave the [Same Result] set to Off (initial default setting).
4. After all of the settings are the way you want, select [Execute] and then press OK .
 - The screen showing execution of the simulation will appear, and then the screen will change to the Result Type menu.

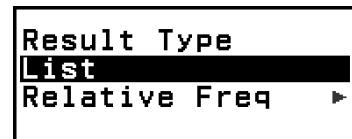

List: Shows a list of the outcome of each roll (trial).^{*1}

Relative Freq: Shows the number of occurrences based on roll results^{*2} and their relative frequencies.

^{*1} When there are two dice, the outcome of each roll is displayed along with each roll's sum and difference. When there are three dice, the outcome of each roll is displayed along with the sum of the roll.

^{*2} Outcome (1 through 6) in the case of one die, sum (2 through 12) or difference (0 through 5) of the outcomes in the case of two dice, and sum (3 through 18) of the outcomes in the case of three dice.

5. Use the Result Type menu to select a result display format.

(1) Here, we want to display the number of occurrences and relative frequencies, so select [Relative Freq] and then press **OK**.

- This displays the [Sum] or [Difference] selection menu.

(2) Here, we want to display the difference in the outcome of each roll, so select [Difference] and then press **OK**.

- The simulation result is displayed on the Relative Freq screen.

A screenshot of the "Relative Freq" screen. It displays a table with three columns: "Diff", "Freq", and "Rel Fr". The data rows are: (0, 14, 0.14), (1, 28, 0.28), (2, 18, 0.18), and (3, 21, 0.21). To the right of the table, it says "Attempts 100" and "0.14" at the bottom right.

Diff	Freq	Rel Fr
0	14	0.14
1	28	0.28
2	18	0.18
3	21	0.21

Attempts 100
0.14

(The result differs with each execution.)

- For details about the simulation result screen, see "[Dice Roll Result Screen](#)" (page 82).

6. To display results using a different format, display the result screen and then press **↶**.

- This returns to the Result Type menu, so you can repeat step 5 of this procedure and change the result display format.

7. If you want to perform a simulation with different settings, press **↶** while the Result Type menu is displayed.

- This clears the simulation result and returns to the parameter input screen. Perform the procedure again from step 3.

8. To exit Dice Roll, press **↶** while the parameter input screen is displayed.

- This returns to the Math Box menu.

Note

- On the Relative Freq screen, you can store the value in a Rel Fr column cell to a variable. For example, performing the following operation in step 5, above, will store

the value in the first row of the "Rel Fr" column to variable A: $\text{[A=]} > \text{[Store]}$. For details about variables, see ["Variables \(A, B, C, D, E, F, x, y, z\)" \(page 34\)](#).

Dice Roll Result Screen

- List screen

	A	B	Sum	Diff
1	3	6	9	3
2	5	3	8	2
3	6	3	9	3
4	2	2	4	0

- (1) Each row shows a sequential roll number. For example, 1 is the first roll, 2 is the second roll, and so on.
- (2) A, B, and C indicate each of the die being used. "Sum" is for the outcome total, and "Diff" is for the difference between the outcomes of two dice. The columns that appear on the display depend on how many dice are being used.
 - 1 die: A-column only.
 - 2 dice: A, B, Sum, and Diff columns.
 - 3 dice: A, B, C, and Sum columns.

- Relative Freq screen

Sum	Freq	Rel Fr
1	46	0.184
2	35	0.14
3	31	0.124
4	39	0.156

Attempts: 250

0.184

- (1) Sum or Diff: Shows the one die outcome (Sum: 1 through 6), two dice outcome sum (Sum: 2 through 12) or difference (Diff: 0 through 5), or three dice outcome sum (Sum: 3 through 18).
- (2) Freq: Shows the number of occurrences (frequency) of each roll outcome.
- (3) Rel Fr: Shows the relative frequency (frequency divided by number of rolls) of roll results.
- (4) Number of trials
- (5) Highlighted Rel Fr cell's value

Same Result Setting

When executing a Dice Roll or Coin Toss simulation with Same Result at its initial default setting (Off), each execution displays a different (random) result. If the Same Result setting is changed to something other than Off, the displayed results are those determined by the calculator. Using the #1, #2, or #3 setting is useful when you want the same result to be displayed by all the calculators being used by the students in a class.

Note

- To have multiple calculators display the same result, make sure that the settings below are identical on all of the calculators.
 - Number of dice or coins
 - Number of trials (rolls or tosses)
 - Same Result setting (#1, #2, or #3)

Coin Toss

Coin Toss performs a simulation of one, two, or three virtual coin tosses a specified number of times. You can select either of the following screens for the result.

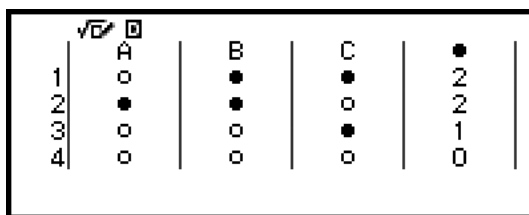

	A	B	C	●
1	○	●	●	2
2	●	●	○	2
3	○	○	●	1
4	○	○	○	0

List screen

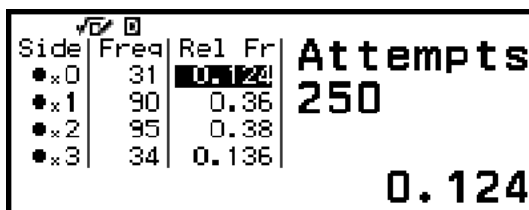

Side	Freq	Rel Fr	Attempts
●x0	31	0.124	250
●x1	90	0.36	
●x2	95	0.38	
●x3	34	0.136	

0.124

Relative Freq screen

The screen shows heads as ● and tails as ○.

Coin Toss General Operation Procedure

Example: To simulate 100 tosses of three coins. For this example, the Relative Freq screen is used for simulation results, showing the number of heads (0, 1, 2, 3) and the relative frequencies of heads of each toss.

1. Press Ⓐ , select the Math Box app icon, and then press Ⓚ .
 - This displays the Math Box menu.

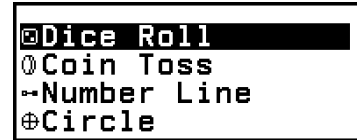

2. Select [Coin Toss], and then press **OK**.
 - This displays the parameter input screen.



Coins: Select the number of coins as 1, 2, or 3.

Attempts: Input the number of coin tosses (number of trials) as a value from 1 to 250.

Same Result: This setting is normally Off (initial default setting). For details, see ["Same Result Setting" \(page 83\)](#).

3. Select each of the menu settings and configure them the way you want.
 - (1) Select [Coins] and then press **OK**. On the menu that appears, select [3 Coins] and then press **OK**.
 - (2) Select [Attempts] and then press **OK**. When the input screen appears, input 100 and then press **OK**. Select [Confirm] and then press **OK**.
 - (3) Leave the [Same Result] set to Off (initial default setting).
4. After all of the settings are the way you want, select [Execute] and then press **OK**.
 - The screen showing execution of the simulation will appear, and then the screen will change to the Result Type menu.

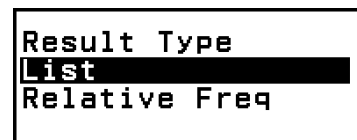

List: Shows a list of heads or tails*¹ for each toss (trial).

Relative Freq: Shows the number of occurrences for each coin that comes up heads,*² and their relative frequencies.

*¹ When there are two or three coins, shows the number of coins of each toss that come up heads.

*² For two or three coins. When there is one coin, this shows the frequencies of heads and tails and the relative frequencies.

5. Use the Result Type menu to select a result display format. Here we want to display the number of occurrences and relative frequencies, so select [Relative Freq] and then press **OK**.
 - The simulation result is shown on the Relative Freq screen.

Side	Freq	Rel Fr	Attempts
•x0	9	0.09	100
•x1	33	0.33	
•x2	47	0.47	
•x3	11	0.11	

0.09

(The result differs with each execution.)

- For details about the simulation result screen, see **"Coin Toss Result Screen"** (page 85).
- To display results using a different format, display the result screen and then press \odot .
 - This returns to the Result Type menu, so you can repeat step 5 of this procedure and change the result display format.
 - If you want to perform a simulation with different settings, press \odot while the Result Type menu is displayed.
 - This clears the simulation result and returns to the parameter input screen. Perform the procedure again from step 3.
 - To exit Coin Toss, press \odot while the parameter input screen is displayed.
 - This returns to the Math Box menu.

Note

- On the Relative Freq screen, you can store the value in a Rel Fr column cell to a variable. For example, performing the following operation in step 5, above, will store the value in the first row of the "Rel Fr" column to variable A: \odot – [A=] > [Store].

Coin Toss Result Screen

- List screen

	A	B	C	
1	○	●	●	2
2	●	●	○	2
3	○	○	●	1
4	○	○	○	0

- Each row shows a sequential toss number. For example, 1 is the first toss, 2 is the second toss, and so on.
 - A, B, and C indicate each of the coins being used. When two coins or three coins are being used, the ● column on the right shows the number of coins that came up heads.
- Relative Freq screen

Side	Freq	Rel Fr	Attempts
●x0	31	0.36	250
●x1	90	0.36	
●x2	95	0.38	
●x3	34	0.136	0.124

- (1) Side: When using only one coin, "●" indicates heads while "○" indicates tails. When using two or three coins, this column shows the number of heads (0 to 3).
- (2) Freq: Shows the number of occurrences (frequency) of each toss outcome.
- (3) Rel Fr: Shows the relative frequency (frequency divided by number of tosses) of toss results.
- (4) Number of trials
- (5) Highlighted Rel Fr cell's value

Number Line

Number Line registers up to three equations or inequalities and displays their number line graphs. The expression types that can be selected are shown below.

$$x < a, x \leq a, x = a, x > a, x \geq a, a < x < b, a \leq x < b, a < x \leq b, a \leq x \leq b$$

The values that you input for a and b in the above expressions must be within the ranges defined below.

$$-1 \times 10^{10} \leq a \leq 1 \times 10^{10}$$

$$-1 \times 10^{10} \leq b \leq 1 \times 10^{10}$$

Number Line General Operation Procedure

Example: To register following three inequalities and display their number line graphs: $x \leq -1.5$, $x > -1.0$, $-2.0 < x \leq -0.5$

1. Press ☰ , select the Math Box app icon, and then press OK .
 - This displays the Math Box menu.

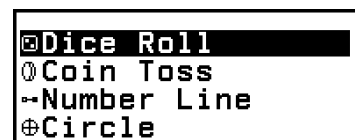

2. Select [Number Line], and then press OK .
 - This displays the expression registration screen.



3. Perform the steps below to register $x \leq -1.5$ in Line A.

(1) Select [A:], and then press OK .

(2) On the expression type list that appears, select [$x \leq a$] and then press OK .

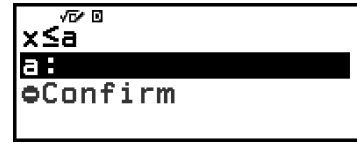

(3) Input -1.5 for a.

$\uparrow \ominus ((-)) 1 \cdot 5 \text{OK}$

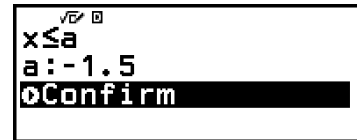

(4) After making sure that [Confirm] is selected, press OK .

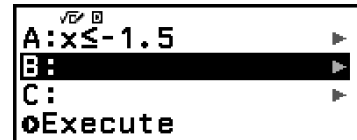

4. Use the steps shown in step 3 to register $x > -1.0$ in Line B and $-2.0 < x \leq -0.5$ in Line C.

[B:] > [$x > a$]

$\uparrow \ominus ((-)) 1 \cdot 0 \text{OK OK}$

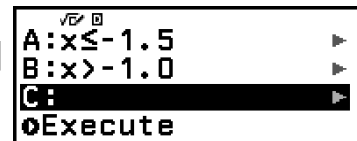

[C:] > [$a < x \leq b$]

$\uparrow \ominus ((-)) 2 \cdot 0 \text{OK}$

$\uparrow \ominus ((-)) 0 \cdot 5 \text{OK OK}$



5. After you finish registering all the expressions, select [Execute] on the expression registration screen, and then press OK .

- This displays the number line graph screen. You can use \leftarrow and \rightarrow to scroll the number line graph left or right.

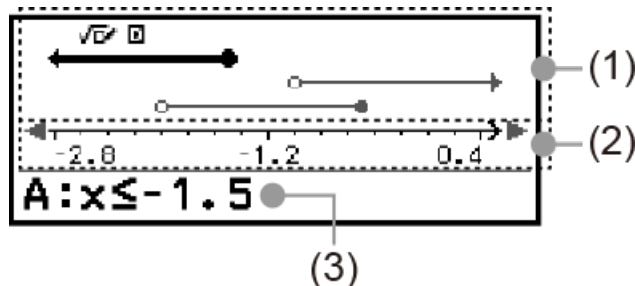

- (1) Shows the number lines of the equations or inequalities registered in lines A, B, and C in sequence from top to bottom. The meanings of the arrows (\leftarrow , \rightarrow) and circles (\bullet , \circ) displayed on either end of the number lines are described below.

- ← Indicates continuation of a range smaller than a in the inequality $x < a$, or a range less than or equal to a in $x \leq a$.
 - Indicates continuation of a range greater than a in the inequality $x > a$ or a range greater than or equal to a in $x \geq a$.
 - Indicates that this value itself (in the case of an equation) or inclusion of this value (in the case of an inequality).
 - Indicates non-inclusion of this value (in the case of an inequality).
- (2) x -axis. This shows the center and either end values.
- (3) Shows the equations or inequalities of the currently selected number line (the number line displayed in bold). To display a different number line expression, use \wedge and \vee to move the bolding to the number line whose expression you want to view.
6. To change the expression, display the number line graph screen and then press \odot .
- This returns to the expression registration screen. You can change only the values of a registered expression, or you can re-register another type of expression. For information about how to do this, see ["Modifying a Registered Expression" \(page 88\)](#).
7. To exit Number Line, press \odot on the expression registration screen.
- This clears the registered expression and returns to the Math Box menu.

Important!

- If you change the Angle Unit setting on the SETTINGS menu, all expressions currently registered in Number Line will be deleted.

Modifying a Registered Expression

To modify a registered expression

Example: To change the expression in Line C ($-2.0 < x \leq -0.5$) to $-1.5 < x \leq 0.5$

1. On the expression registration screen, select Line C and then press OK .
2. On the menu that appears, select [Edit] and then press OK .
3. Input -1.5 for a and 0.5 for b.
 $\uparrow \ominus ((-)) 1 \cdot 5 \text{OK} 0 \cdot 5 \text{OK}$
4. After making sure that [Confirm] is selected, press OK .

To re-register another type of expression

Example: To change the expression in Line A ($x \leq -1.5$) to $x = -1.5$

1. On the expression registration screen, select Line A and then press OK .
2. On the menu that appears, select [Define New] and then press OK .
3. On the expression type list that appears, select [$x = a$] and then press OK .

4. Input -1.5 for a.

\uparrow \ominus $((-))$ 1 \ominus 5 OK

5. After making sure that [Confirm] is selected, press OK .

To delete a registered expression

On the expression registration screen, select the registered expression you want to delete, and then press X .

Changing the Display Range of the Number Line Graph Screen (View-Window)

When you register an expression and display the number line graph screen, optimal display range settings are configured automatically. You can change the display range by changing Center (1) and Scale (2) settings of the x -axis. Use the View-Window screen to change display range settings.

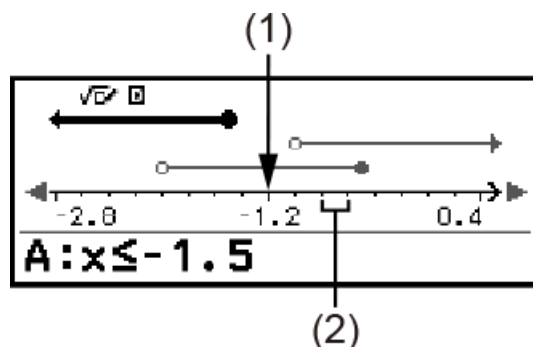

Example: To change the x -axis Scale setting to 1 and the Center setting to 2, and display a number line graph

1. Display the number line graph screen.
2. Press VW , select [View-Window], and then press OK .
 - This displays the View-Window screen.

$\sqrt{\text{E}} \text{D}$
Scale : 0.2
Center : -1.2
 Execute

3. Input 1 for [Scale] and 2 for [Center].

$\sqrt{\text{E}} \text{D}$
Scale : 1
Center : 2
 Execute

4. After making sure that [Execute] is selected, press OK .

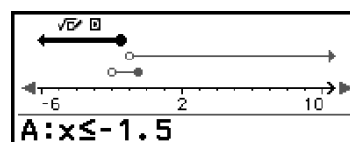

Note

- The maximum and minimum values for the x -axis depend on the Center and Scale settings, as shown below.

Maximum value: (Center Value) + (Scale Value) \times 8

Minimum Value: (Center Value) - (Scale Value) \times 8

- After changing the View-Window settings, you can restore the Center and Scale settings to their automatically configured display range settings by performing the operation: $\text{⊞} - [\text{View-Reset}]$.

- The values that you input for Scale and Center must be within the ranges defined below.

$$1 \times 10^{-10} \leq \text{Scale} \leq 1 \times 10^{10}$$

$$-1 \times 10^{10} \leq \text{Center} \leq 1 \times 10^{10}$$

Circle

Circle provides the functions described below, which can be used to learn about angles and trigonometric functions.

• Unit Circle and Half Circle Graphics

The Unit Circle graphic shows the unit circle with a radius of 1, while the Half Circle graphic shows a half circle with a radius of 1. Both the unit circle and half circle are centered on the origin of rectangular coordinates. The figures below show each type of circle with angles of θ_1 and θ_2 , along with trigonometric function values.

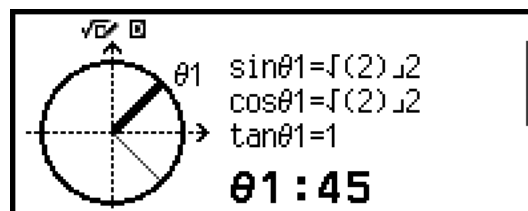

Unit Circle

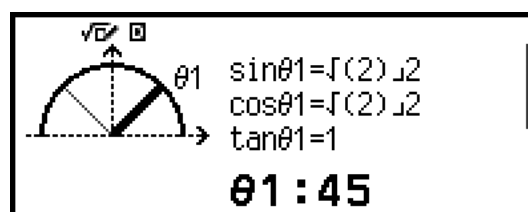

Half Circle

• Clock Graphic

The Clock graphic can be used to show the two angles that the hour and minute hands form depending on the time of day. The figure below shows a clock graphic with angles θ_1 and θ_2 . In this graphic, the position of the minute hand is fixed at 12 o'clock.

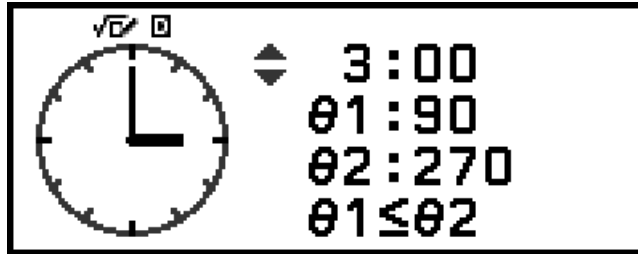

Clock

Circle General Operation Procedure

1. Press MATH , select the Math Box app icon, and then press OK .
 - This displays the Math Box menu.

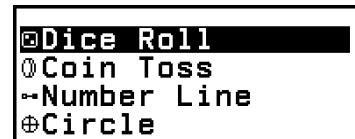

2. Configure the Angle Unit setting as required.
 - You can select any one of the following units for angle value input: Degree, Radian, Gradian. See ["Changing Calculator Settings" \(page 19\)](#).
3. Select [Circle], and then press OK .
 - This displays the parameter input screen.

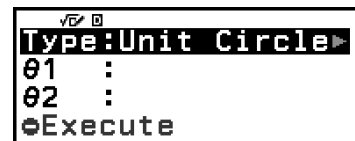

- If you want to select Unit Circle for this procedure, you can proceed directly to step 5. (In this case, press V to selects $[\theta 1]$ in step 5.)
4. Select the Circle type you want to use.
 - (1) Select [Type], and then press OK .
 - (2) On the type list that appears, select [Unit Circle], [Half Circle], or [Clock] and then press OK .
 - If you selected [Unit Circle] or [Half Circle], you can proceed directly to step 5.
 - If you selected [Clock], proceed to step 6.
 5. Input the $[\theta 1]$ and $[\theta 2]$ angles.
 - When inputting an angle value, use the unit for the currently selected Angle Unit setting.
 - For example, perform the operation below to input 45° for $[\theta 1]$ and 135° for $[\theta 2]$ (Angle Unit: Degree).

45 OK 135 OK

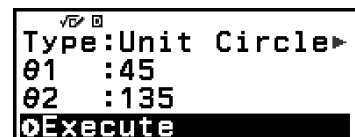

- For the allowable input range for angle values, see the "Note" below.
6. After making sure that [Execute] is selected, press **OK**.
- This displays the graphic screen.

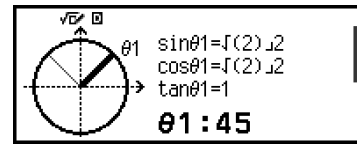

- Refer to the sections below for information about how to view the graphic screen and perform its operations.
- **"Unit Circle and Half Circle Graphic Screens" (page 92)**
 - **"Clock Graphic Screen" (page 93)**
7. Press **←** to return to the parameter input screen from the graphic screen.
8. To exit Circle, display the parameter input screen and then press **→**.
- This returns to the Math Box menu.

Note

- The table below shows the allowable input ranges for values you input in step 5 above.

Angle Unit setting	Unit Circle	Half Circle
Degree	-10000 < θ < 10000	$0 \leq \theta \leq 180$
Radian		$0 \leq \theta \leq \pi^*$
Gradian		$0 \leq \theta \leq 200$

* 3.1415926535897932384626

Unit Circle and Half Circle Graphic Screens

The Unit Circle and Half Circle appear as shown below. The sample displays below are for when values for both θ_1 and θ_2 have been input.

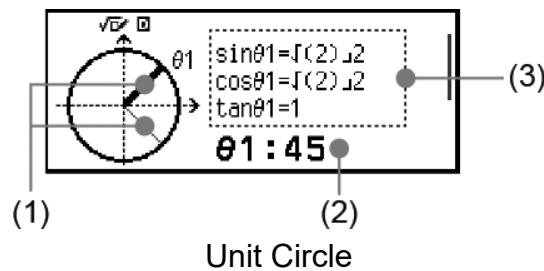

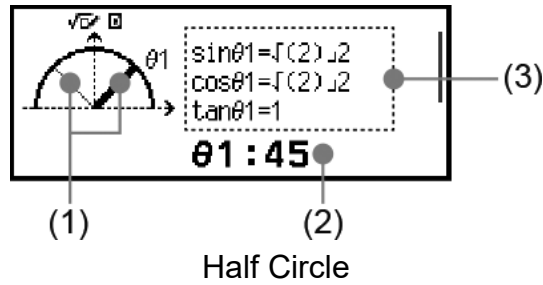

- (1) Lines forming angles $[\theta_1]$ and $[\theta_2]$. The currently selected line is thicker than the other line. You can change the selection between θ_1 and θ_2 by pressing \wedge or \vee .
- (2) Angle value of the currently selected line's angle (θ_1 or θ_2).
- (3) Trigonometric function values of the currently selected line's angle (θ_1 or θ_2).

Note

- When only a single angle (θ_1 or θ_2) is input, a single thick line will be displayed to form the angle. In this case, the angle value of the single angle is shown for (2), and trigonometric function values for the angle are shown for (3).
- On the graphic screen, the values of the trigonometric functions are displayed in accordance with the settings of Input/Output and Angle Unit.
- When MathI/MathO or MathI/DecimalO is selected for Input/Output, trigonometric values may include fraction or $\sqrt{\quad}$ values as applicable.
Example: $\sin(45) = \sqrt{2}/2$, $\cos(30) = \sqrt{3}/2$ (Angle Unit: Degree)

Clock Graphic Screen

The example below shows a typical Clock graphic screen.

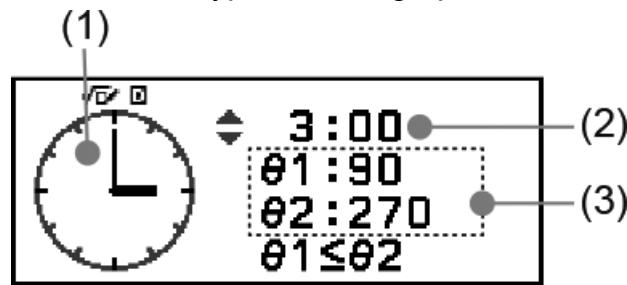

- (1) Clock graphic. The Clock always initially indicates 12 o'clock. Press \wedge to advance the hour hand by one hour, or \vee to move it back.
- (2) Time indicated by the clock.
- (3) θ_1 : The smaller angle between the hour and minute hands.
 θ_2 : The larger angle between the hour and minute hands.

Note

- Angle values are displayed in accordance with the settings of Input/Output and Angle Unit.
- If Radian is selected for Angle Unit and MathI/MathO is selected for Input/Output, the angle value will be displayed in π format.

Technical Information

Errors

The calculator will display an error message whenever an error occurs for any reason during a calculation.

Displaying the Location of an Error

While an error message is displayed, pressing OK , ↵ , or AC returns to the screen that was displayed immediately before the error message appeared. The cursor will be positioned at the location where the error occurred, ready for input. Make the necessary corrections to the calculation and execute it again.

Example: When you input $14 \div 0 \times 2$ by mistake instead of $14 \div 10 \times 2$.

The diagram shows three stages of calculator operation:

- Stage 1:** The user inputs $14 \div 0 \times 2$ and presses EXE . The calculator screen displays "Math ERROR" with a warning triangle icon and a "Back" button at the bottom.
- Stage 2:** The user presses OK (or ↵ or AC). The screen returns to the input screen showing $14 \div 0 \times 2$.
- Stage 3:** The user presses the left arrow key (←) to move the cursor to the "0" and then inputs "1". The screen now shows $14 \div 10 \times 2$ with the cursor at the "1". Pressing EXE results in the final answer $\frac{14}{5}$.

Error Messages

Syntax ERROR

Cause:

- There is a problem with the format of the calculation you are performing.

Action:

- Make necessary corrections.

Math ERROR

Cause:

- The intermediate or final result of the calculation you are performing exceeds the allowable calculation range.

- Your input exceeds the allowable input range (particularly when using functions).
- The calculation you are performing contains an illegal mathematical operation (such as division by zero).

Action:

- Check the input values, reduce the number of digits, and try again.
 - When using a variable as the argument of a function, make sure that the variable value is within the allowable range for the function.
-

Stack ERROR

Cause:

- The calculation you are performing has caused the capacity of the numeric stack or the command stack to be exceeded.

Action:

- Simplify the calculation expression so it does not exceed the capacity of the stack.
 - Try splitting the calculation into two or more parts.
-

Argument ERROR

Cause:

- There is a problem with the argument of the calculation you are performing.

Action:

- Make necessary corrections.
-

Range ERROR

Cause (Table app):

- An attempt to generate a number table in the Table app whose conditions cause it to exceed the maximum number of allowable rows.

Action:

- Narrow the table calculation range by changing the Start, End, and Step values, and try again.

Cause (Math Box app):

- The value input as the Attempts (number of trials) for Dice Roll or Coin Toss is outside the allowable range or is a non-integer value.
- The value input on the expression registration screen of Number Line is outside the allowable range, or you entered an inequality with an invalid maximum-minimum relationship (like $10 < x \leq 5$).
- A value input on the View-Window screen of Number Line is outside the allowable range.

Action:

- For Attempts, input an integer value that is within the allowable range.
 - On the expression registration screen, input a value that is within the allowable range. In the case of an invalid maximum-minimum relationship for an entered inequality, edit the inequality to correct the maximum-minimum relationship.
 - On the View-Window screen, input values that are within the allowable range.
-

Circular ERROR ($f(x)$ and $g(x)$ feature only)**Cause:**

- Circular reference is occurring in a registered composite function (["Registering a Composite Function" \(page 54\)](#)).

Action:

- Do not have $g(x)$ input into $f(x)$, and $f(x)$ input into $g(x)$ at the same time.
-

Not Defined ($f(x)$ and $g(x)$ feature only)**Cause:**

- You attempted to calculate $f(x)$ or $g(x)$ with $f(x)/g(x)$ undefined.

Action:

- Define $f(x)$ or $g(x)$ before calculating $f(x)/g(x)$.

Before Assuming Malfunction of the Calculator...

Note that you should make separate copies of important data before performing these steps.

1. Check the calculation expression to make sure that it does not contain any errors.
2. Make sure that you are using the correct calculator app for the type of calculation you are trying to perform.
 - To check which calculator app you are currently using, press \odot . This highlights the icon of the calculator app currently in use.
3. If the above steps do not correct your problem, press the \downarrow key.
 - This causes the calculator to perform a routine that checks whether calculation functions are operating correctly. If the calculator discovers any abnormality, it automatically initializes the calculator app and clears memory contents.

4. Return the calculator settings (except for Contrast and Auto Power Off) to their initial default settings by performing the procedure below.
 - (1) Press \odot , select a calculator app icon, and then press OK .
 - (2) Press \equiv , and then select [Reset] > [Settings & Data] > [Yes].

Replacing the Battery

If the screen shown below appears right after you turn on power, it means that remaining battery power is low.

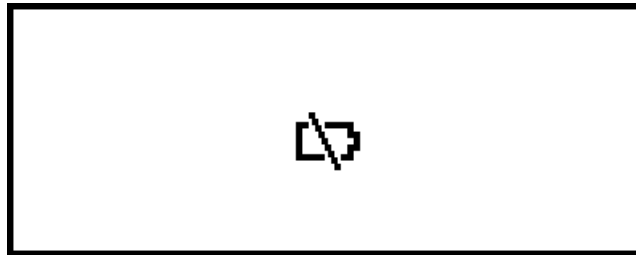

A low battery is also indicated by a dim display, even if contrast is adjusted, or by failure of figures to appear on the display immediately after you turn on the calculator.

If this happens or the above screen appears, replace the battery with a new one.

Important!

- Removing the battery causes all of the calculator's memory contents to be cleared.

1. Press \uparrow AC (OFF) to turn off the calculator.
 - To ensure that you do not accidentally turn on power while replacing the battery, attach the front cover to the front of the calculator.
2. As shown in the illustration, remove the battery cover, remove the battery, and then load a new battery with its plus (+) and minus (-) ends facing correctly.

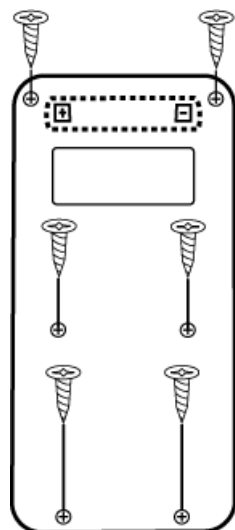

fx-83GT CW

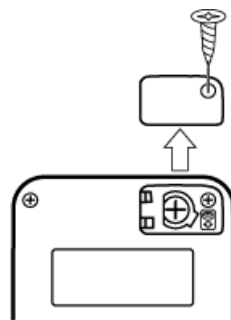

fx-85GT CW

3. Replace the battery cover.
4. Press ON to turn on the calculator.
5. Initialize the calculator.
 - (1) Press MODE , select a calculator app icon, and then press OK .
 - (2) Press MENU , and then select [Reset] > [Initialize All] > [Yes].
 - Do not skip the above steps!

Calculation Priority Sequence

The calculator performs calculations according to a calculation priority sequence.





- Basically, calculations are performed from left to right.
- Expressions within parentheses have the highest priority.
- The following shows the priority sequence for each individual command.

1	Parenthetical expressions
2	Functions that have parentheses (sin(, log(, f(, g(, etc., functions that take an argument to the right, functions that require a closing parenthesis after the argument)
3	Functions that come after the input value (x^2 , x^{-1} , $x!$, $^{\circ}$, $^{\circ}$, $^{\circ}$, $^{\circ}$, $^{\circ}$, $^{\circ}$, $^{\circ}$), powers (x^{\blacksquare}), roots ($\sqrt{\blacksquare}$)
4	Fractions
5	Negative sign ((-))
6	Statistics app estimated values (\hat{x} , \hat{y} , \hat{x}_1 , \hat{x}_2)

7	Multiplication where the multiplication sign is omitted
8	Permutation (nPr), combination (nCr)
9	Multiplication (\times), division (\div)
10	Addition ($+$), subtraction ($-$)



If a calculation contains a negative value, you may need to enclose the negative value in parentheses. If you want to square the value -2, for example, you need to input: $(-2)^2$. This is because x^2 is a function preceded by a value (Priority 3, above), whose priority is greater than the negative sign, which is a prefix symbol (Priority 5).



Example:











 $-2^2 = -4$



 $(-2)^2 = 4$

Calculation Ranges, Number of Digits, and Precision

The calculation range, number of digits used for internal calculation, and calculation precision depend on the type of calculation you are performing.

Calculation Range and Precision

Calculation Range	$\pm 1 \times 10^{-99}$ to $\pm 9.999999999 \times 10^{99}$ or 0
Number of Digits for Internal Calculation	23 digits
Precision	In general, ± 1 at the 10th digit for a single calculation. Precision for exponential display is ± 1 at the least significant digit. Errors are cumulative in the case of consecutive calculations.

Function Calculation Input Ranges and Precision

Functions	Input Range	
sinx cosx	Degree	$0 \leq x < 9 \times 10^9$
	Radian	$0 \leq x < 157079632.7$
	Gradian	$0 \leq x < 1 \times 10^{10}$
tanx	Degree	Same as sinx, except when $ x = (2n - 1) \times 90$.
	Radian	Same as sinx, except when $ x = (2n - 1) \times \pi/2$.
	Gradian	Same as sinx, except when $ x = (2n - 1) \times 100$.
$\sin^{-1}x, \cos^{-1}x$	$0 \leq x \leq 1$	
$\tan^{-1}x$	$0 \leq x \leq 9.999999999 \times 10^{99}$	
\sinhx, \coshx	$0 \leq x \leq 230.2585092$	
$\sinh^{-1}x$	$0 \leq x \leq 4.999999999 \times 10^{99}$	
$\cosh^{-1}x$	$1 \leq x \leq 4.999999999 \times 10^{99}$	
\tanhx	$0 \leq x \leq 9.999999999 \times 10^{99}$	
$\tanh^{-1}x$	$0 \leq x \leq 9.999999999 \times 10^{-1}$	
\logx, \lnx	$0 < x \leq 9.999999999 \times 10^{99}$	
10^x	$-9.999999999 \times 10^{99} \leq x \leq 99.99999999$	
\sqrt{x}	$0 \leq x < 1 \times 10^{100}$	
x^2	$ x < 1 \times 10^{50}$	
x^{-1}	$ x < 1 \times 10^{100}; x \neq 0$	
$x!$	$0 \leq x \leq 69$ (x is an integer)	

nPr	$0 \leq n < 1 \times 10^{10}$, $0 \leq r \leq n$ (n, r are integers) $1 \leq \{n!/(n-r)!\} < 1 \times 10^{100}$
nCr	$0 \leq n < 1 \times 10^{10}$, $0 \leq r \leq n$ (n, r are integers) $1 \leq n!/r! < 1 \times 10^{100}$ or $1 \leq n!/(n-r)! < 1 \times 10^{100}$
$\text{Pol}(x, y)$	$ x , y \leq 9.999999999 \times 10^{99}$ $\sqrt{x^2 + y^2} \leq 9.999999999 \times 10^{99}$
$\text{Rec}(r, \theta)$	$0 \leq r \leq 9.999999999 \times 10^{99}$ θ : Same as $\sin x$
$a^\circ b'c''$	$ a , b, c < 1 \times 10^{100}$; $0 \leq b, c$ The display seconds value is subject to an error of ± 1 at the second decimal place.
$a^\circ b'c'' = x$	$0^\circ 0' 0'' \leq x \leq 9999999^\circ 59' 59''$ A sexagesimal value outside of the above range is automatically treated as a decimal value.
x^y	$x > 0$: $-1 \times 10^{100} < y \log x < 100$ $x = 0$: $y > 0$ $x < 0$: $y = n, \frac{m}{2n+1}$ (m, n are integers) However: $-1 \times 10^{100} < y \log x < 100$
$\sqrt[x]{y}$	$y > 0$: $x \neq 0, -1 \times 10^{100} < 1/x \log y < 100$ $y = 0$: $x > 0$ $y < 0$: $x = 2n+1, \frac{2n+1}{m}$ ($m \neq 0$; m, n are integers) However: $-1 \times 10^{100} < 1/x \log y < 100$
$a^{b/c}$	Total of integer, numerator, and denominator must be 10 digits or less (including separator symbol).
$\text{RanInt}\#(a, b)$	$a < b$; $ a , b < 1 \times 10^{10}$; $b - a < 1 \times 10^{10}$
$\text{GCD}(a, b)$	$ a , b < 1 \times 10^{10}$ (a, b are integers)
$\text{LCM}(a, b)$	$0 \leq a, b < 1 \times 10^{10}$ (a, b are integers)

- Precision is basically the same as that described under "Calculation Range and Precision", above.

- x^y , $\sqrt[x]{y}$, $x!$, nPr , nCr type functions require consecutive internal calculation, which can cause accumulation of errors that occur with each calculation.
- Error is cumulative and tends to be large in the vicinity of a function's singular point and inflection point.
- The range for calculation results that can be displayed in π form when MathI/MathO is selected for Input/Output on the SETTINGS menu is $|x| < 10^6$. Note, however, that internal calculation error can make it impossible to display some calculation results in π form. It also can cause calculation results that should be in decimal form to appear in π form.

Specifications

fx-83GT CW

Power Requirements:

AAA-size battery R03 \times 1

Approximate Battery Life:

2 years (based on one hour of operation per day)

Power Consumption:

0.0008 W

Operating Temperature:

0°C to 40°C (32°F to 104°F)

Dimensions:

13.8 (H) \times 77 (W) \times 162 (D) mm

$\frac{9}{16}$ " (H) \times $3 \frac{1}{16}$ " (W) \times $6 \frac{3}{8}$ " (D)

Approximate Weight:

100 g (3.5 oz) including the battery

fx-85GT CW

Power Requirements:

Built-in solar cell; button battery LR44 \times 1

Approximate Battery Life:

2 years (based on one hour of operation per day)

Operating Temperature:

0°C to 40°C (32°F to 104°F)

Dimensions:

10.7 (H) × 77 (W) × 162 (D) mm

$7/16$ " (H) × $3\ 1/16$ " (W) × $6\ 3/8$ " (D)

Approximate Weight:

95 g (3.4 oz) including the battery

Frequently Asked Questions

Frequently Asked Questions

■ How can I change a fraction form result produced by a division operation to decimal form?

→ While a fraction calculation result is displayed, press FORMAT and then select [Decimal], or press \uparrow EXE (\approx). To have calculation results initially appear as decimal values, change the Input/Output setting on the SETTINGS menu to MathI/DecimalO.

■ What is the difference between Ans memory and variable memory?

→ Each of these types of memory acts like "containers" for temporary storage of a single value.

Ans Memory: Stores the result of the last calculation performed. Use this memory to carry the result of one calculation on to the next.

Variables: This memory is helpful when you need to use the same value multiple times in one or more calculations.

■ How can I find a function I was using with an older CASIO calculator model on this calculator?

→ This calculator's functions can be accessed from the CATALOG menu that appears when you press CATALOG . For details, see the sections below.

["Using the CATALOG Menu" \(page 23\)](#)

["Advanced Calculations" \(page 45\)](#)

■ With an older CASIO calculator model, I pressed S+D to change the calculation result display format. What should I do with this calculator?

→ While a calculation result is displayed, press FORMAT . Use the menu that appears to select the display format you want. For details, see

["Changing Calculation Result Format" \(page 37\)](#).

■ How can I find out which calculator app I am currently using?

→ Press HOME . This causes the icon of the calculator app you are currently using to become highlighted.

■ How do I calculate $\sin^2 x$

→ For example, to calculate $\sin^2 30 = \frac{1}{4}$, enter the calculation below.

sin 30 $)$ ■^2 EXE

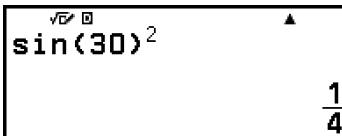

The image shows a calculator screen with the expression $\text{sin}(30)^2$ entered. The result $\frac{1}{4}$ is displayed in the bottom right corner. Above the screen, the sequence of buttons pressed is shown: sin , 30 , $)$, ■^2 , and EXE .

■ **Why does the battery icon (🔋) appear right after the calculator is turned on?**

→ The battery icon indicates that battery power is low. If you see this icon, replace the battery as soon as possible. For details about battery replacement, see ["Replacing the Battery" \(page 98\)](#).

■ **How can I return the calculator to its initial default settings?**

→ Perform the procedure below to initialize calculator settings (except for Contrast and Auto Power Off).

(1) Press , select a calculator app icon, and then press .

(2) Press , and then select [Reset] > [Settings & Data] > [Yes].

CASIO®

SA2212-A

© 2022 CASIO COMPUTER CO., LTD.