

Precision 7780

Service Manual

Notes, cautions, and warnings

 **NOTE:** A NOTE indicates important information that helps you make better use of your product.

 **CAUTION:** A CAUTION indicates either potential damage to hardware or loss of data and tells you how to avoid the problem.

 **WARNING:** A WARNING indicates a potential for property damage, personal injury, or death.

Chapter 1: Working inside your computer	6
Safety instructions.....	6
Before working inside your computer.....	6
Safety precautions.....	7
Electrostatic discharge—ESD protection.....	7
ESD field service kit	8
Transporting sensitive components.....	9
After working inside your computer.....	9
BitLocker.....	9
Chapter 2: Removing and installing components	10
Recommended tools.....	10
Screw list.....	10
Major components of Precision 7780.....	12
Base cover.....	14
Removing the base cover.....	14
Installing the base cover.....	19
Battery.....	21
Rechargeable Li-ion battery precautions.....	21
Removing the battery.....	22
Installing the battery.....	24
SIM card.....	25
Removing the SIM card.....	25
Installing the SIM card.....	27
Compression Attached Memory (CAMM) module.....	28
Removing the Compression Attached Memory (CAMM) module.....	28
Installing the Compression Attached Memory (CAMM) module.....	29
Memory modules.....	31
Removing the memory module.....	31
Installing the memory module.....	31
Memory interposer board.....	32
Removing the interposer board module.....	32
Installing the interposer board module.....	34
WLAN card.....	35
Removing the WLAN card.....	35
Installing the WLAN card.....	36
Wireless Wide Area Network (WWAN) card.....	38
Removing the WWAN card.....	38
Installing the WWAN card.....	39
Solid State Drive.....	40
Removing the primary M.2 Solid-state drive.....	40
Installing the primary M.2 SSD module.....	41
Secondary M.2 solid-state drive.....	42
Removing the secondary M.2 Solid-state drive.....	42











Installing the secondary M.2 SSD module.....	46
Heat sink.....	50
Removing the heat sink for discrete graphics.....	50
Installing the heat sink for discrete graphics.....	51
GPU card.....	52
Removing the GPU card.....	52
Installing the GPU card.....	53
GPU power cable.....	54
Removing the GPU power cable.....	54
Installing the GPU power cable.....	55
Power button board.....	55
Removing the power button board.....	55
Installing the power button board.....	56
Power button.....	58
Removing the power button.....	58
Installing the power button.....	58
Speakers.....	59
Removing the speakers.....	59
Installing the speakers.....	60
Inner frame.....	62
Removing the inner frame.....	62
Installing the inner frame.....	63
SD card reader.....	65
Removing SD card reader.....	65
Installing SD card reader.....	66
SD card reader FPC.....	66
Removing SD card reader FPC.....	66
Installing SD card reader FPC.....	67
System board.....	68
Removing the system board.....	68
Installing the system board.....	72
Coin-cell battery.....	75
Removing the coin-cell battery.....	75
Installing the coin-cell battery.....	76
Display assembly.....	77
Removing the display assembly.....	77
Installing the display assembly.....	80
Power-adapter port.....	82
Removing the power-adapter port.....	82
Installing the power-adapter port.....	83
Smart-card reader.....	84
Removing the smart-card reader.....	84
Installing the smart-card reader.....	85
Keyboard.....	86
Removing the keyboard.....	86
Installing the keyboard.....	89
Palm rest.....	92
Removing the palm rest.....	92
Installing the palm rest.....	93

Chapter 3: Drivers and downloads.....	95
Chapter 4: BIOS setup.....	96
Entering BIOS setup program.....	96
Navigation keys.....	96
One time boot menu.....	96
BIOS setup options.....	97
Clearing chassis intrusion alert.....	108
Updating the BIOS.....	109
Updating the BIOS in Windows.....	109
Updating the BIOS in Linux and Ubuntu.....	110
Updating the BIOS using the USB drive in Windows.....	110
Updating the BIOS from the F12 One-Time boot menu.....	110
System and setup password.....	111
Assigning a system setup password.....	111
Deleting or changing an existing system setup password.....	112
Clearing CMOS settings.....	112
Clearing BIOS (System Setup) and System passwords.....	113
Chapter 5: Troubleshooting.....	114
Handling swollen rechargeable Li-ion batteries.....	114
Dell SupportAssist Pre-boot System Performance Check diagnostics.....	114
Running the SupportAssist Pre-Boot System Performance Check.....	115
Built-in self-test (BIST).....	115
M-BIST.....	115
LCD Power rail test (L-BIST).....	116
LCD Built-in Self Test (BIST).....	116
System-diagnostic lights.....	116
Recovering the operating system.....	118
Real-Time Clock (RTC Reset).....	118
Backup media and recovery options.....	119
Wi-Fi power cycle.....	119
Drain residual flea power (perform hard reset).....	119
Chapter 6: Getting help and contacting Dell.....	120

Working inside your computer

Safety instructions

Use the following safety guidelines to protect your computer from potential damage and to ensure your personal safety. Unless otherwise noted, each procedure included in this document assumes that you have read the safety information that shipped with your computer.

-  **WARNING:** Before working inside your computer, read the safety information that is shipped with your computer. For more safety best practices, see the Regulatory Compliance home page at www.dell.com/regulatory_compliance.
-  **WARNING:** Disconnect your computer from all power sources before opening the computer cover or panels. After you finish working inside the computer, replace all covers, panels, and screws before connecting your computer to an electrical outlet.
-  **CAUTION:** To avoid damaging the computer, ensure that the work surface is flat, dry, and clean.
-  **CAUTION:** To avoid damaging the components and cards, handle them by their edges, and avoid touching the pins and the contacts.
-  **CAUTION:** You should only perform troubleshooting and repairs as authorized or directed by the Dell technical assistance team. Damage due to servicing that is not authorized by Dell is not covered by your warranty. See the safety instructions that is shipped with the product or at www.dell.com/regulatory_compliance.
-  **CAUTION:** Before touching anything inside your computer, ground yourself by touching an unpainted metal surface, such as the metal at the back of the computer. While you work, periodically touch an unpainted metal surface to dissipate static electricity which could harm internal components.
-  **CAUTION:** When you disconnect a cable, pull it by its connector or its pull tab, not the cable itself. Some cables have connectors with locking tabs or thumbscrews that you must disengage before disconnecting the cable. When disconnecting cables, keep them evenly aligned to avoid bending the connector pins. When connecting cables, ensure that the ports and the connectors are correctly oriented and aligned.
-  **CAUTION:** Press and eject any installed card from the media-card reader.
-  **CAUTION:** Exercise caution when handling rechargeable Li-ion batteries in laptops. Swollen batteries should not be used and should be replaced and disposed properly.
-  **NOTE:** The color of your computer and certain components may appear differently than shown in this document.

Before working inside your computer

About this task

-  **NOTE:** The images in this document may differ from your computer depending on the configuration you ordered.

Steps

1. Save and close all open files and exit all open applications.
2. Shut down your computer. For Windows operating system, click **Start** >  **Power** > **Shut down**.

 **NOTE:** If you are using a different operating system, see the documentation of your operating system for shut-down instructions.

3. Disconnect your computer and all attached devices from their electrical outlets.
4. Disconnect all attached network devices and peripherals, such as keyboard, mouse, and monitor from your computer.

 **CAUTION:** To disconnect a network cable, first unplug the cable from your computer and then unplug the cable from the network device.

5. Remove any media card and optical disc from your computer, if applicable.

Safety precautions

The safety precautions chapter details the primary steps to be taken before performing any disassembly instructions.

Observe the following safety precautions before you perform any installation or break/fix procedures involving disassembly or reassembly:

- Turn off the system and all attached peripherals.
- Disconnect the system and all attached peripherals from AC power.
- Disconnect all network cables, telephone, and telecommunications lines from the system.
- Use an ESD field service kit when working inside any to avoid electrostatic discharge (ESD) damage.
- After removing any system component, carefully place the removed component on an anti-static mat.
- Wear shoes with non-conductive rubber soles to reduce the chance of getting electrocuted.

Standby power

Dell products with standby power must be unplugged before you open the case. Systems that incorporate standby power are essentially powered while turned off. The internal power enables the system to be remotely turned on (wake on LAN) and suspended into a sleep mode and has other advanced power management features.

Unplugging, pressing, and holding the power button for 15 seconds should discharge residual power in the system board.

Bonding

Bonding is a method for connecting two or more grounding conductors to the same electrical potential. This is done through the use of a field service electrostatic discharge (ESD) kit. When connecting a bonding wire, ensure that it is connected to bare metal and never to a painted or non-metal surface. The wrist strap should be secure and in full contact with your skin, and ensure that you remove all jewelry such as watches, bracelets, or rings prior to bonding yourself and the equipment.

Electrostatic discharge—ESD protection

ESD is a major concern when you handle electronic components, especially sensitive components such as expansion cards, processors, memory DIMMs, and system boards. Very slight charges can damage circuits in ways that may not be obvious, such as intermittent problems or a shortened product life span. As the industry pushes for lower power requirements and increased density, ESD protection is an increasing concern.

Due to the increased density of semiconductors used in recent Dell products, the sensitivity to static damage is now higher than in previous Dell products. For this reason, some previously approved methods of handling parts are no longer applicable.

Two recognized types of ESD damage are catastrophic and intermittent failures.

- **Catastrophic** – Catastrophic failures represent approximately 20 percent of ESD-related failures. The damage causes an immediate and complete loss of device functionality. An example of catastrophic failure is a memory DIMM that has received a static shock and immediately generates a "No POST/No Video" symptom with a beep code emitted for missing or nonfunctional memory.
- **Intermittent** – Intermittent failures represent approximately 80 percent of ESD-related failures. The high rate of intermittent failures means that most of the time when damage occurs, it is not immediately recognizable. The DIMM receives a static shock, but the tracing is merely weakened and does not immediately produce outward symptoms related to the damage. The weakened trace may take weeks or months to melt, and in the meantime may cause degradation of memory integrity, intermittent memory errors, etc.

The more difficult type of damage to recognize and troubleshoot is the intermittent (also called latent or "walking wounded") failure.

Perform the following steps to prevent ESD damage:

- Use a wired ESD wrist strap that is properly grounded. The use of wireless anti-static straps is no longer allowed; they do not provide adequate protection. Touching the chassis before handling parts does not ensure adequate ESD protection on parts with increased sensitivity to ESD damage.
- Handle all static-sensitive components in a static-safe area. If possible, use anti-static floor pads and workbench pads.
- When unpacking a static-sensitive component from its shipping carton, do not remove the component from the anti-static packing material until you are ready to install the component. Before unwrapping the anti-static packaging, ensure that you discharge static electricity from your body.
- Before transporting a static-sensitive component, place it in an anti-static container or packaging.

ESD field service kit

The unmonitored Field Service kit is the most commonly used service kit. Each Field Service kit includes three main components: anti-static mat, wrist strap, and bonding wire.

Components of an ESD field service kit

The components of an ESD field service kit are:

- **Anti-Static Mat** – The anti-static mat is dissipative and parts can be placed on it during service procedures. When using an anti-static mat, your wrist strap should be snug and the bonding wire should be connected to the mat and to any bare metal on the system being worked on. Once deployed properly, service parts can be removed from the ESD bag and placed directly on the mat. ESD-sensitive items are safe in your hand, on the ESD mat, in the system, or inside a bag.
- **Wrist Strap and Bonding Wire** – The wrist strap and bonding wire can be either directly connected between your wrist and bare metal on the hardware if the ESD mat is not required, or connected to the anti-static mat to protect hardware that is temporarily placed on the mat. The physical connection of the wrist strap and bonding wire between your skin, the ESD mat, and the hardware is known as bonding. Use only Field Service kits with a wrist strap, mat, and bonding wire. Never use wireless wrist straps. Always be aware that the internal wires of a wrist strap are prone to damage from normal wear and tear, and must be checked regularly with a wrist strap tester in order to avoid accidental ESD hardware damage. It is recommended to test the wrist strap and bonding wire at least once per week.
- **ESD Wrist Strap Tester** – The wires inside of an ESD strap are prone to damage over time. When using an unmonitored kit, it is a best practice to regularly test the strap prior to each service call, and at a minimum, test once per week. A wrist strap tester is the best method for doing this test. If you do not have your own wrist strap tester, check with your regional office to find out if they have one. To perform the test, plug the wrist-strap's bonding-wire into the tester while it is strapped to your wrist and push the button to test. A green LED is lit if the test is successful; a red LED is lit and an alarm sounds if the test fails.
- **Insulator Elements** – It is critical to keep ESD sensitive devices, such as plastic heat sink casings, away from internal parts that are insulators and often highly charged.
- **Working Environment** – Before deploying the ESD Field Service kit, assess the situation at the customer location. For example, deploying the kit for a server environment is different than for a desktop or portable environment. Servers are typically installed in a rack within a data center; desktops or portables are typically placed on office desks or cubicles. Always look for a large open flat work area that is free of clutter and large enough to deploy the ESD kit with additional space to accommodate the type of system that is being repaired. The workspace should also be free of insulators that can cause an ESD event. On the work area, insulators such as Styrofoam and other plastics should always be moved at least 12 inches or 30 centimeters away from sensitive parts before physically handling any hardware components
- **ESD Packaging** – All ESD-sensitive devices must be shipped and received in static-safe packaging. Metal, static-shielded bags are preferred. However, you should always return the damaged part using the same ESD bag and packaging that the new part arrived in. The ESD bag should be folded over and taped shut and all the same foam packing material should be used in the original box that the new part arrived in. ESD-sensitive devices should be removed from packaging only at an ESD-protected work surface, and parts should never be placed on top of the ESD bag because only the inside of the bag is shielded. Always place parts in your hand, on the ESD mat, in the system, or inside an anti-static bag.
- **Transporting Sensitive Components** – When transporting ESD sensitive components such as replacement parts or parts to be returned to Dell, it is critical to place these parts in anti-static bags for safe transport.

ESD protection summary

It is recommended to use the traditional wired ESD grounding wrist strap and protective anti-static mat at all times when servicing Dell products. In addition, it is critical to keep sensitive parts separate from all insulator parts while performing service and that they use anti-static bags for transporting sensitive components.

Transporting sensitive components

When transporting ESD sensitive components such as replacement parts or parts to be returned to Dell, it is critical to place these parts in anti-static bags for safe transport.

After working inside your computer

About this task

 **NOTE:** Leaving stray or loose screws inside your computer may severely damage your computer.

Steps

1. Replace all screws and ensure that no stray screws remain inside your computer.
2. Connect any external devices, peripherals, or cables you removed before working on your computer.
3. Replace any media cards, discs, or any other parts that you removed before working on your computer.
4. Connect your computer and all attached devices to their electrical outlets.
5. Turn on your computer.

BitLocker

 **CAUTION:** If BitLocker is not suspended before updating the BIOS, the next time you reboot the system it will not recognize the BitLocker key. You will then be prompted to enter the recovery key to progress, and the system will ask for this on each reboot. If the recovery key is not known this can result in data loss or an unnecessary operating system reinstall. For more information about this subject, see Knowledge Article: [updating the BIOS on Dell systems with BitLocker enabled](#).

The installation of the following components triggers BitLocker:

- Hard disk drive or solid state drive
- System board

Removing and installing components

NOTE: The images in this document may differ from your computer depending on the configuration you ordered.

Recommended tools

The procedures in this document may require the following tools:

- Phillips screwdriver #0
- Phillips screwdriver #1
- Plastic scribe

Screw list

NOTE: When removing screws from a component, it is recommended to note the screw type, the quantity of screws, and then place them in a screw storage box. This is to ensure that the correct number of screws and correct screw type is restored when the component is replaced.

NOTE: Some computers have magnetic surfaces. Ensure that the screws are not left attached to such surfaces when replacing a component.

NOTE: Screw color may vary with the configuration ordered.

Table 1. Screw list













Component	Screw type	Quantity	Screw image
Base cover	Captive	6	
Battery	M2x7	3	
CAMM module	M2x6	2	
	M2x3.5	2	
Interposer board module NOTE: For models shipped with memory module	M2x6	2	
	M2x5	2	
WLAN	M2x3	1	
WWAN	M2x3.5 (Captive screw)	1	

Table 1. Screw list (continued)

Component	Screw type	Quantity	Screw image
M.2 solid state drive	M2x2.5	2	
M.2 solid state drive2	M2x2.5	2	
Heat-sink for discrete graphics	Captive screws M2x5	8 3	 
GPU card	M2x6 M2x5	4 3	 
Power-button board	M2x3 M2x2	1 2	 
Power-button	M2x3 M2x2	2	 
Speakers  NOTE: Only for 93 Whr battery	M2x2	1	
Inner frame	M2x6 M2x2 M2x2.5	5 8 1	  
SD card reader	M2x2	1	
System board	M2x6 M2x5	4 11	 
Display assembly	M2.5x5 M2x5	6 4	

Table 1. Screw list (continued)

Component	Screw type	Quantity	Screw image
			
Power-adaptor port	M2x3	1	
Smart card reader	M2x2	2	
Keyboard	M2x2.5 M2x2	28 6	 
Palmrest	M2x2.5	2	

Major components of Precision 7780

The following image shows the major components of Precision 7780.

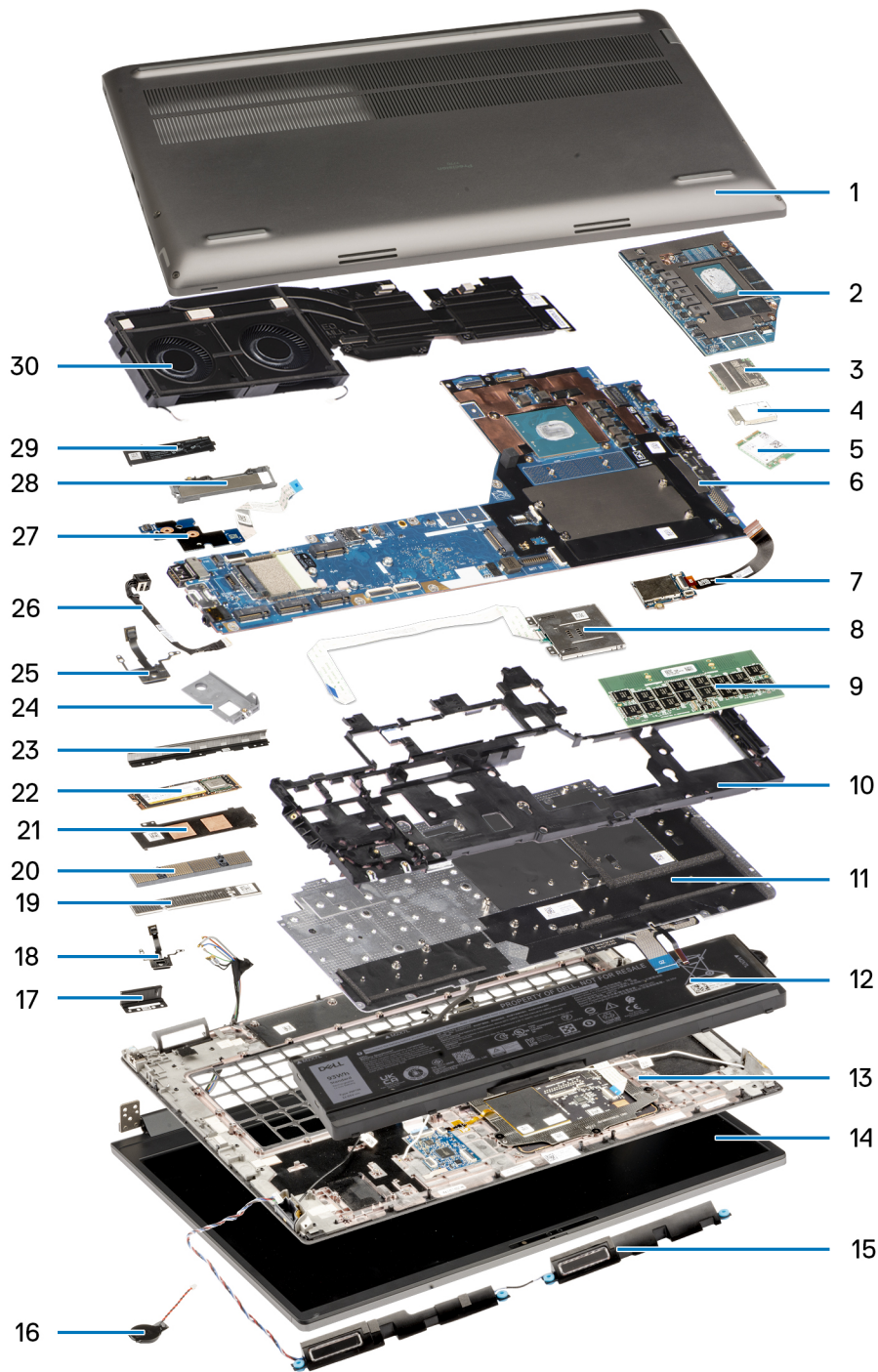

- | | |
|------------------------------|---------------------------|
| 1. Base cover | 2. Discrete GPU |
| 3. WWAN card | 4. WWAN cover |
| 5. WLAN card | 6. System board |
| 7. SD card reader | 8. Smart card reader |
| 9. CAMM module | 10. Inner frame |
| 11. Keyboard | 12. Battery |
| 13. Palm rest | 14. Display assembly |
| 15. Speakers | 16. Coin-cell battery |
| 17. Left dummy fin | 18. Power button |
| 19. CAMM memory bracket | 20. CAMM connector module |
| 21. Solid-state drive shield | 22. Solid-state drive |
| 23. Dummy fin | 24. |

- 25. Power-button board
- 27. GPU power cable
- 29. Solid-state drive plate

- 26. Power-adapter port
- 28. Solid-state drive shield
- 30. Heat-sink

NOTE: Dell provides a list of components and their part numbers for the original system configuration purchased. These parts are available according to warranty coverages purchased by the customer. Contact your Dell sales representative for purchase options.

Base cover

Removing the base cover

Prerequisites

1. Follow the procedure in [before working inside your computer](#).

About this task

The figure indicates the location of the base cover and provides a visual representation of the removal procedure.



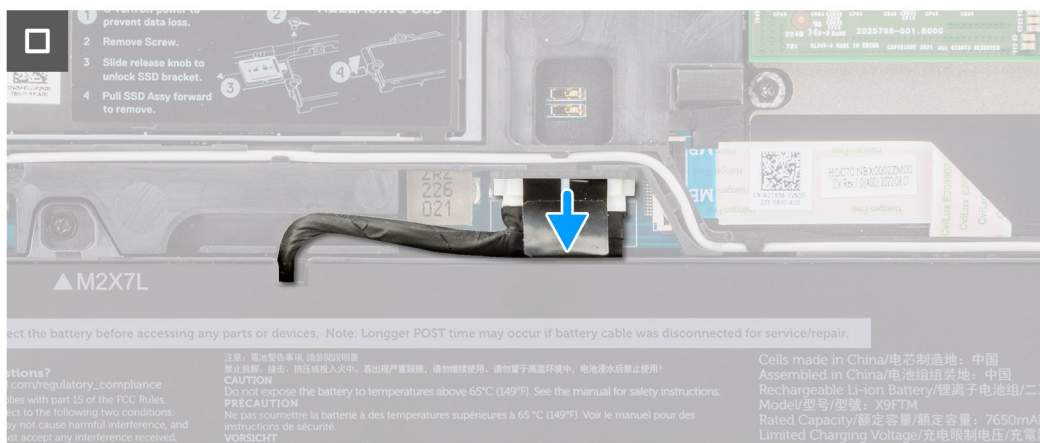
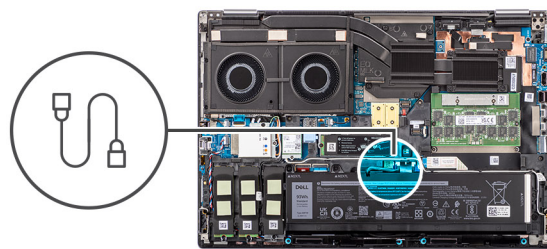
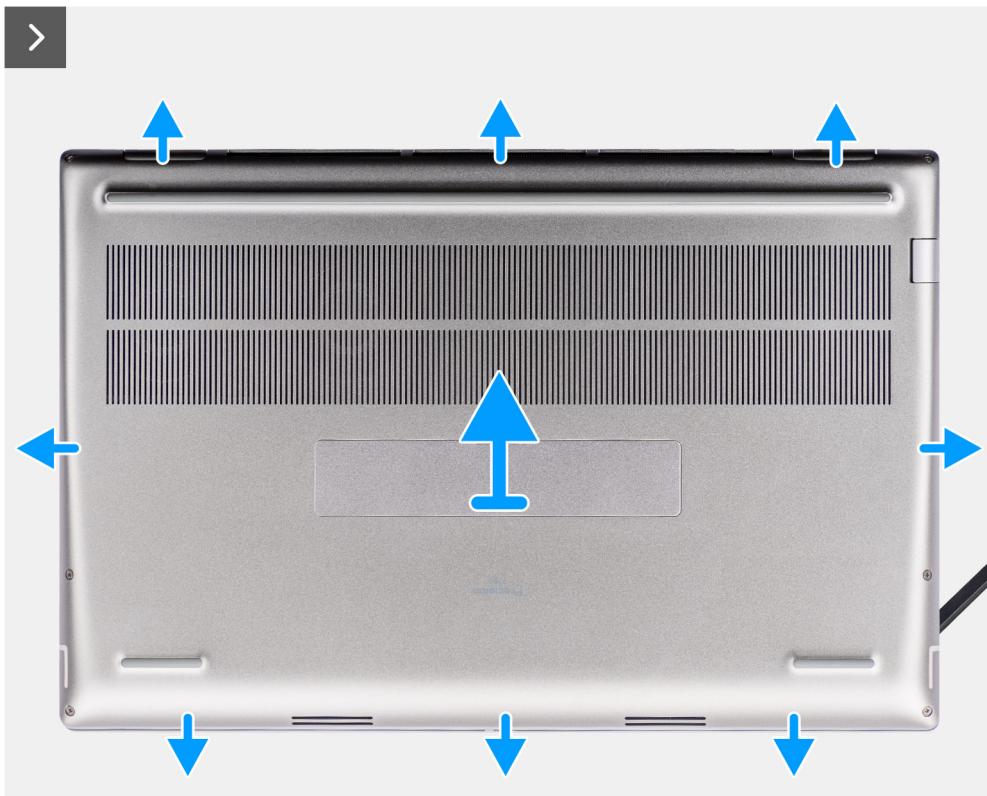

Steps

1. Loosen the six captive screws that secure the base cover to the computer.
2. For computers shipped without a smart-card reader, pry open the base cover starting from the bottom-right corner of the base cover.



NOTE: For models shipped with smart-card reader, pry open the base cover from the smart-card reader slot at the bottom-right side of the base cover.

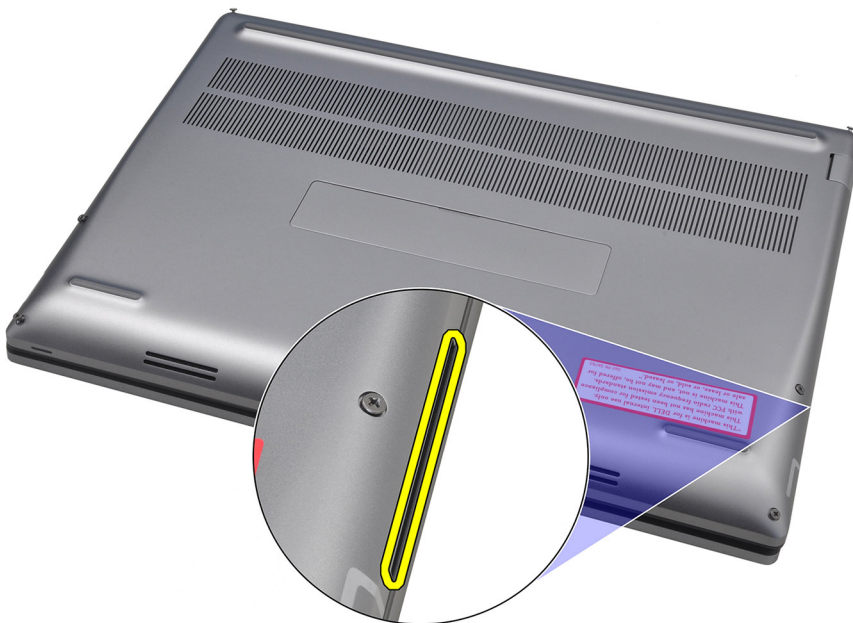

3. Lift the base cover starting from the bottom edge and push it towards the rear to remove it from the computer.

NOTE: Do not lift the base cover directly upwards to remove, as it may damage the rear edge of the cover.

4. Disconnect the battery cable from the connector on the system board.

5. Lift to remove the base cover.

NOTE:

- **WWAN Thermal Pad on Base Cover:** Models that are shipped with WWAN antennas have a WWAN thermal pad on the base cover. If the thermal pad is detached after removing the base cover, reattach it to the base cover.

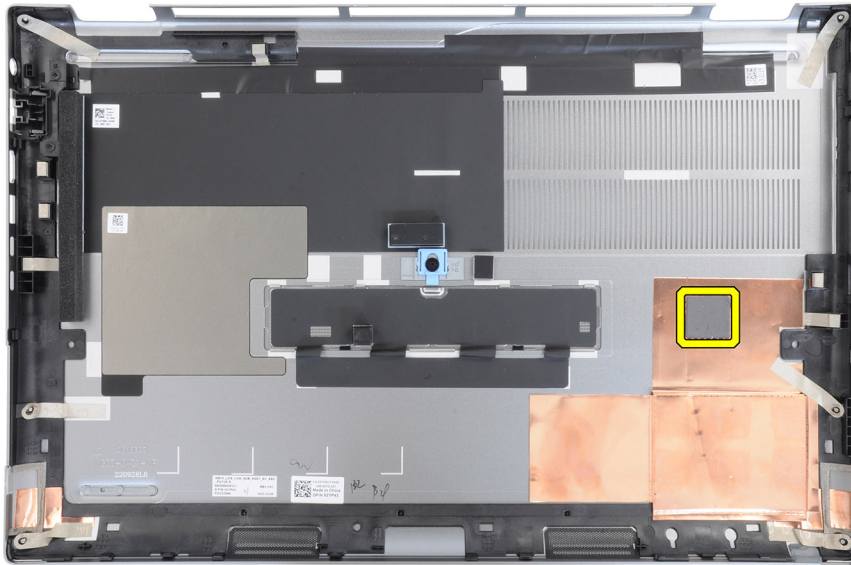

- **Solid-state drive door:** For models shipped with an SSD door, use the latch on the base cover to lock/unlock the door.

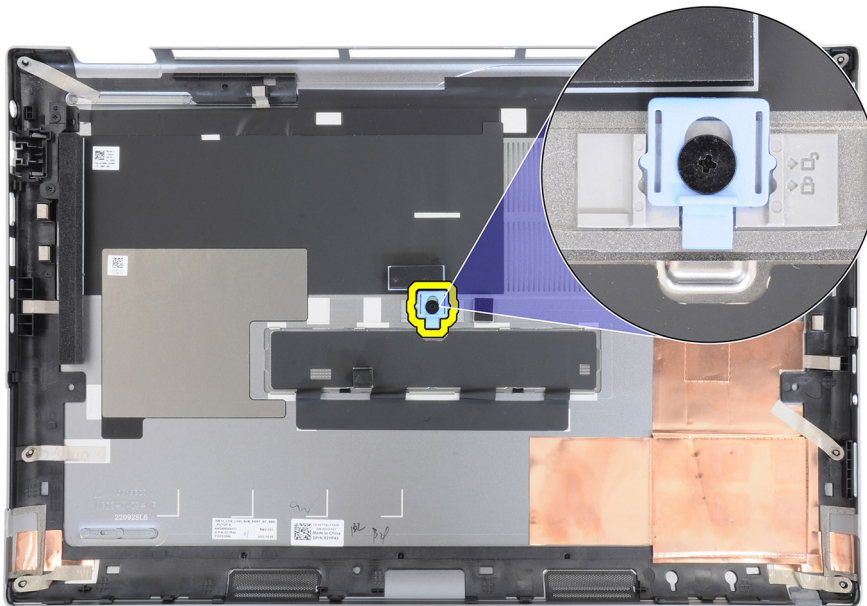

The door is unlocked by default. Push the latch downward to lock the door.

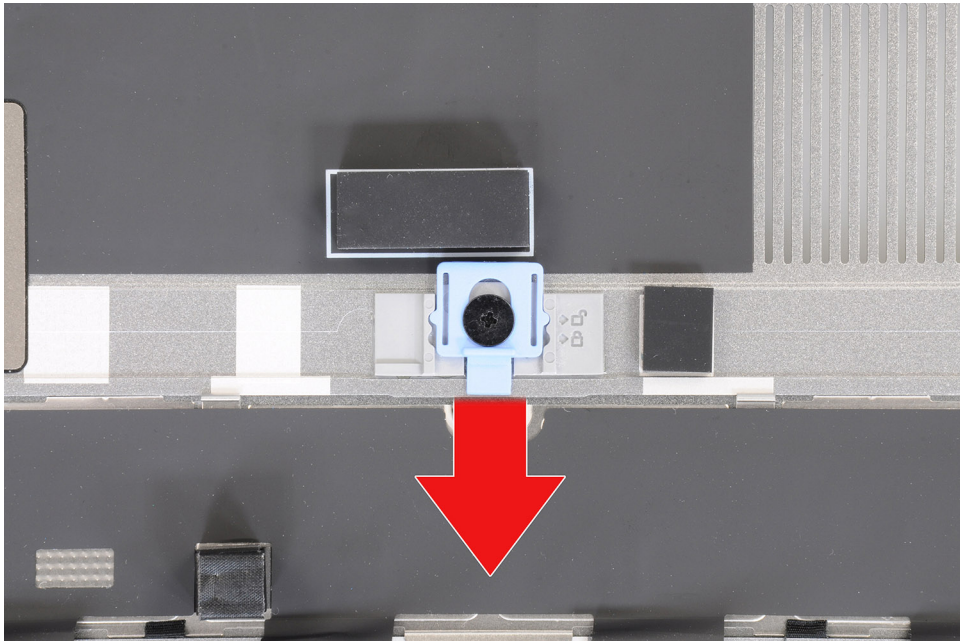

When the door is locked, push the latch upward to unlock the door.

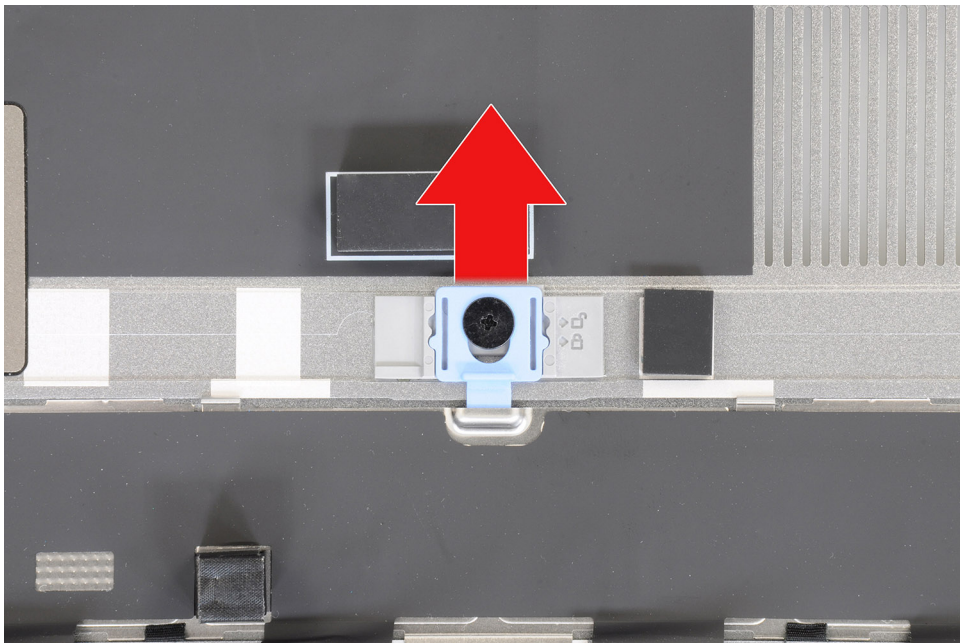

i **NOTE:** The images that are shown above are of Precision 7780. The same information applies to Precision 7680.

6. After removing the base cover, if any of the thermal pads for the M.2 SSDs are detached, reattach them to their correct locations on the system.

Models shipped with an 83 Wh battery:

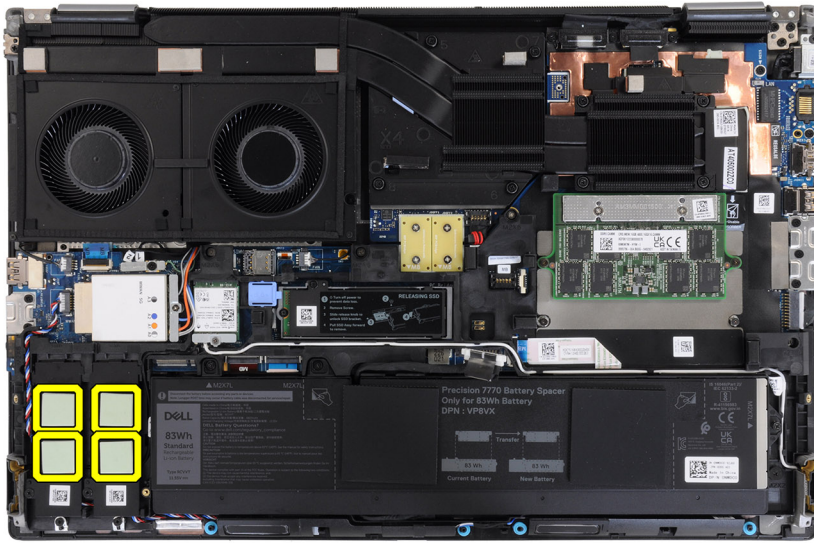

Models shipped with a 93 Wh battery:

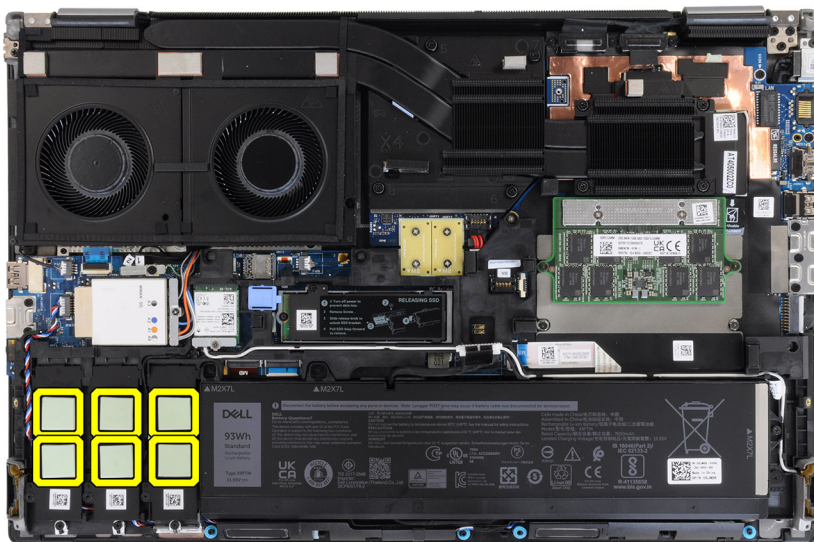

Installing the base cover

Prerequisites

If you are replacing a component, remove the existing component before performing the installation procedure.

About this task

The figure indicates the location of the base cover and provides a visual representation of the installation procedure.

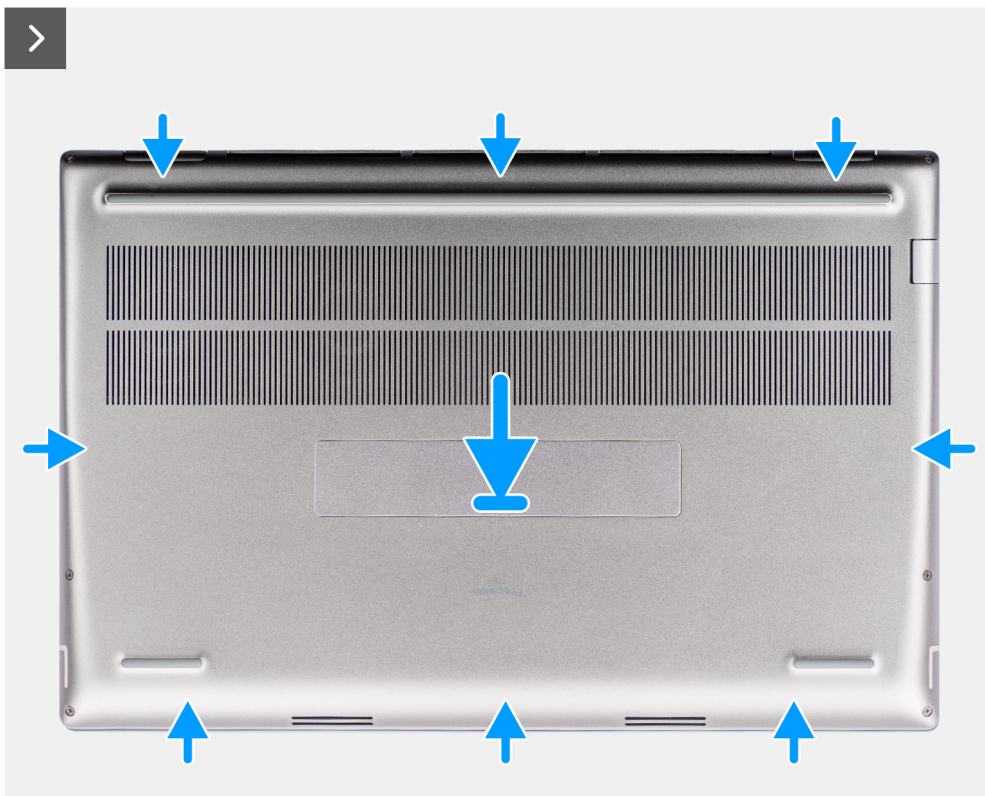
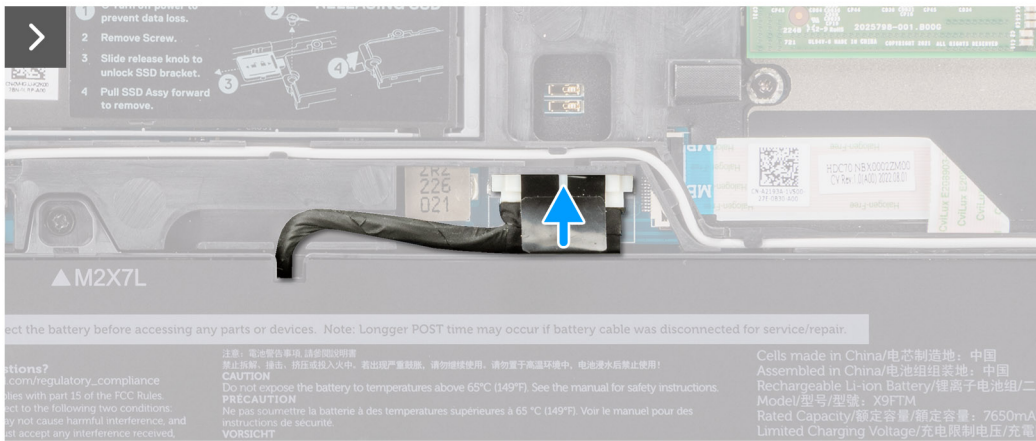
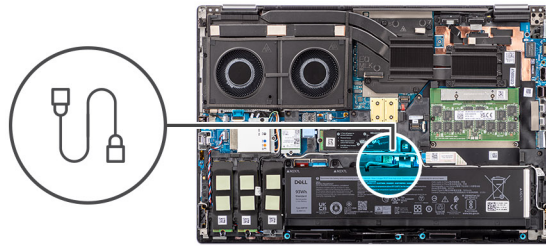



6x



Steps

1. Connect the battery cable to the connector on the system board.
2. Slide the base cover into its slot until it clicks into place.
3. Tighten the six captive screws to secure the base cover to the computer.

Next steps

1. Follow the procedure in [after working inside your computer](#).

Battery

Rechargeable Li-ion battery precautions

⚠ CAUTION:

- Exercise caution when handling rechargeable Li-ion batteries.
- Discharge the battery completely before removing it. Disconnect the AC power adapter from the system and operate the computer solely on battery power—the battery is fully discharged when the computer no longer turns on when the power button is pressed.
- Do not crush, drop, mutilate, or penetrate the battery with foreign objects.
- Do not expose the battery to high temperatures, or disassemble battery packs and cells.

- Do not apply pressure to the surface of the battery.
- Do not bend the battery.
- Do not use tools of any kind to pry on or against the battery.
- Ensure any screws during the servicing of this product are not lost or misplaced, to prevent accidental puncture or damage to the battery and other system components.
- If the battery gets stuck inside your computer as a result of swelling, do not try to release it as puncturing, bending, or crushing a rechargeable Li-ion battery can be dangerous. In such an instance, contact Dell technical support for assistance. See www.dell.com/contactdell.
- Always purchase genuine batteries from www.dell.com or authorized Dell partners and resellers.
- Swollen batteries should not be used and should be replaced and disposed properly. For guidelines on how to handle and replace swollen rechargeable Li-ion batteries, see [Handling swollen rechargeable Li-ion batteries](#).

Removing the battery

Prerequisites

1. Follow the procedure in [before working inside your computer](#).
2. Remove the [base cover](#).

About this task

The figure indicates the location of the battery and provides a visual representation of the removal procedure.



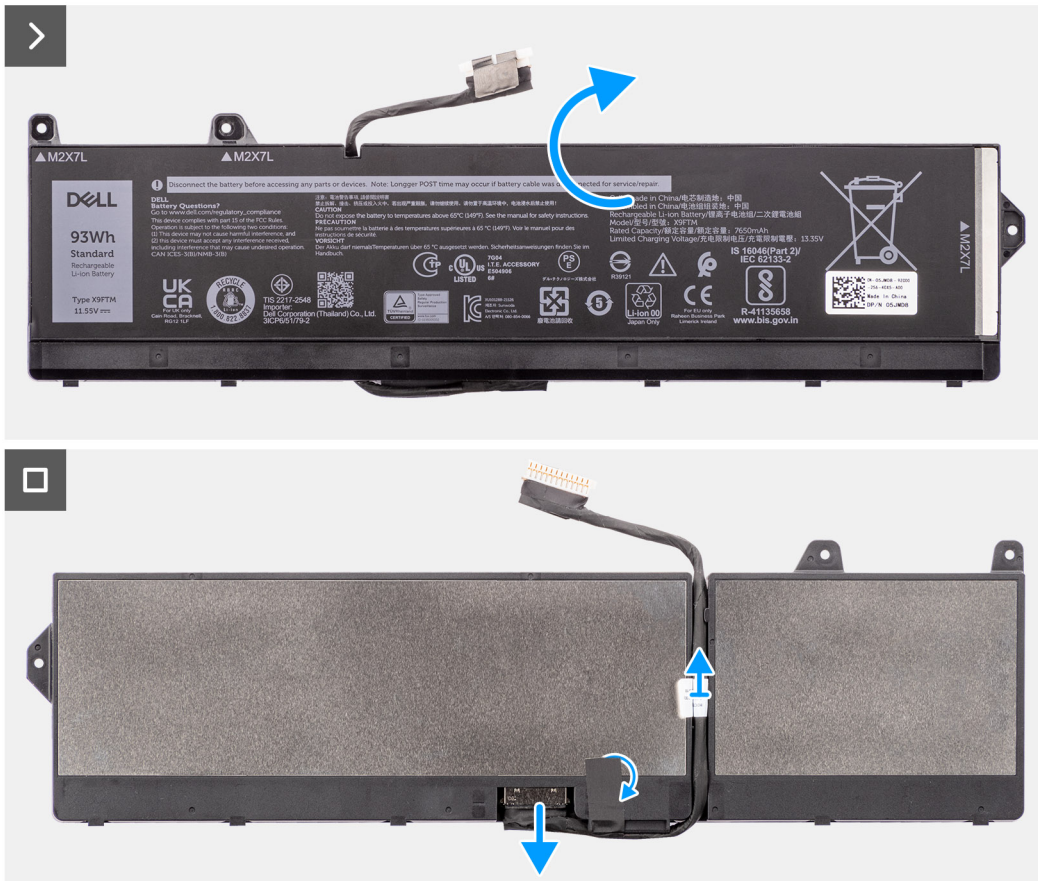

Steps

1. Remove the three (M2x7) screws that secure the battery to the system chassis.
2. Slightly lift the battery at an angle and slide the battery out of the system chassis.

NOTE: For models shipped with an 83 Wh battery, the battery rubber sticker must be transferred to the replacement 83 Wh battery.



3. Flip the battery and peel the adhesive on the battery cable.

4. Unroute the battery cable and disconnect it from its connector on the battery.
5. Lift to remove the battery cable from the battery.

Installing the battery

Prerequisites

If you are replacing a component, remove the existing component before performing the installation procedure.

About this task

The figure indicates the location of the battery and provides a visual representation of the installation procedure.

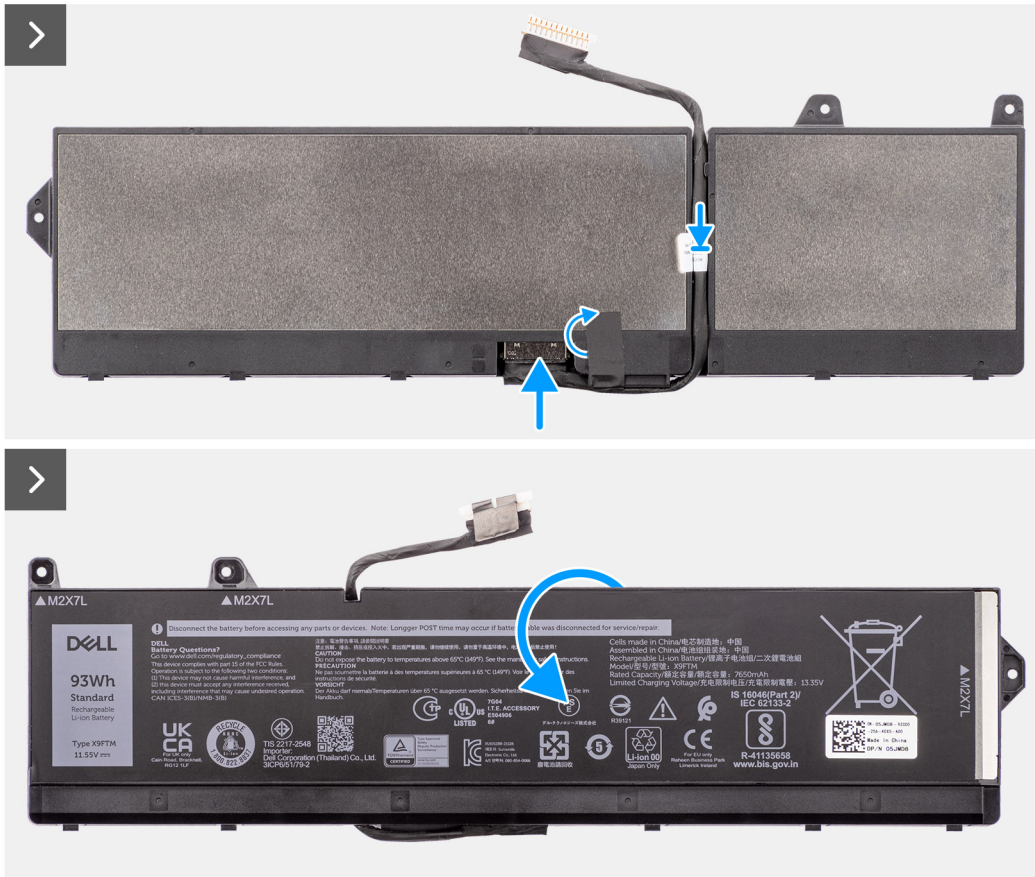



3x
M2x7

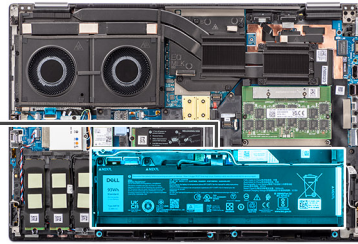
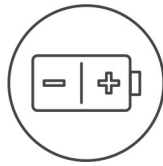

Steps

1. Connect the battery cable to its connector on the battery and route it using the routing channel.
2. Reattach the adhesive on the battery cable and flip the battery.
3. Align the tabs on the battery at an angle with the tab holes on the system chassis.
4. Place the battery onto its slot in the system chassis.
5. Replace the three (M2x7) screws to secure the battery to the system chassis.

Next steps

1. Install the [base cover](#).
2. Follow the procedure in [after working inside your computer](#).

SIM card

Removing the SIM card

Prerequisites

1. Follow the procedure in [before working inside your computer](#).
2. Remove the [base cover](#).

About this task

The figure indicates the location of the SIM card and provides a visual representation of the removal procedure.

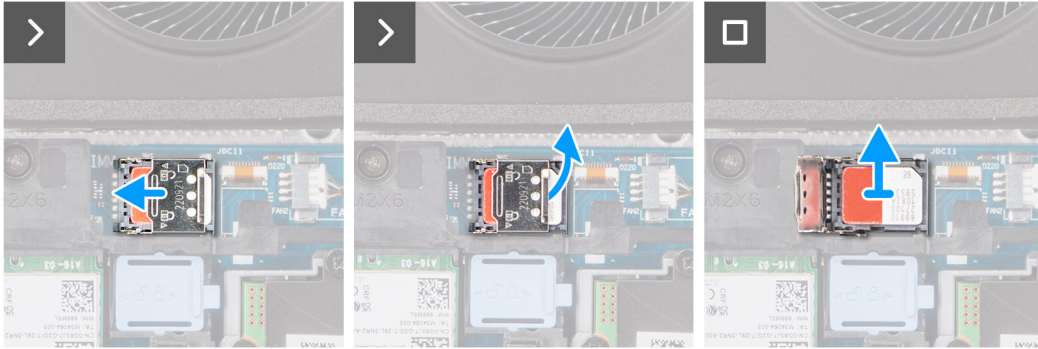
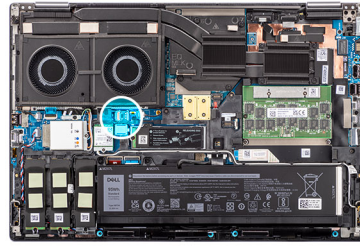

Steps

1. Gently slide the SIM card cover towards the left side of the SIM card slot to unlock the SIM card cover.



CAUTION: The SIM card cover is fragile and can be damaged if it is not properly unlocked before opening.

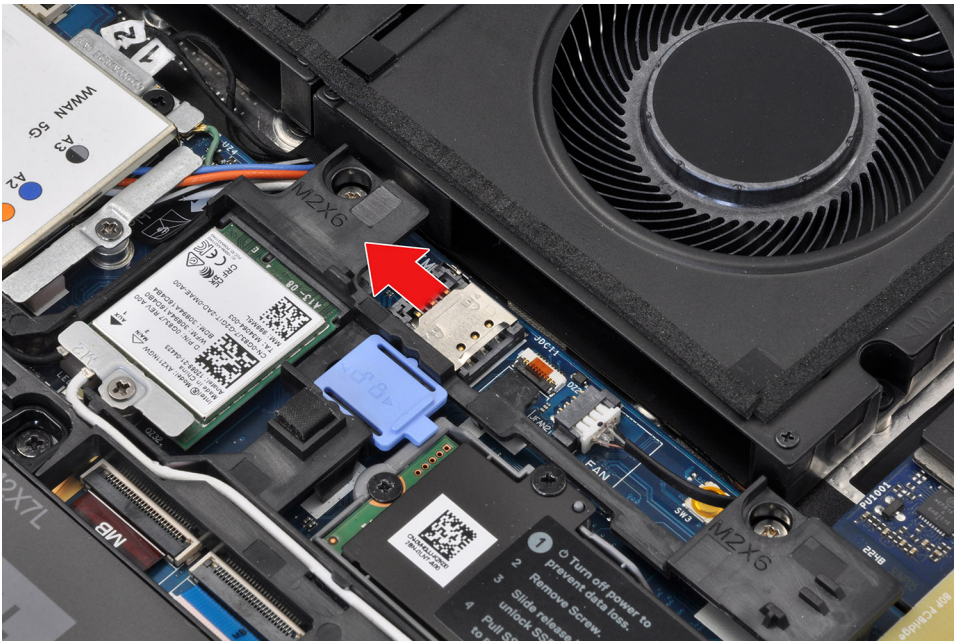

2. Flip the right edge of the SIM card cover to open it.

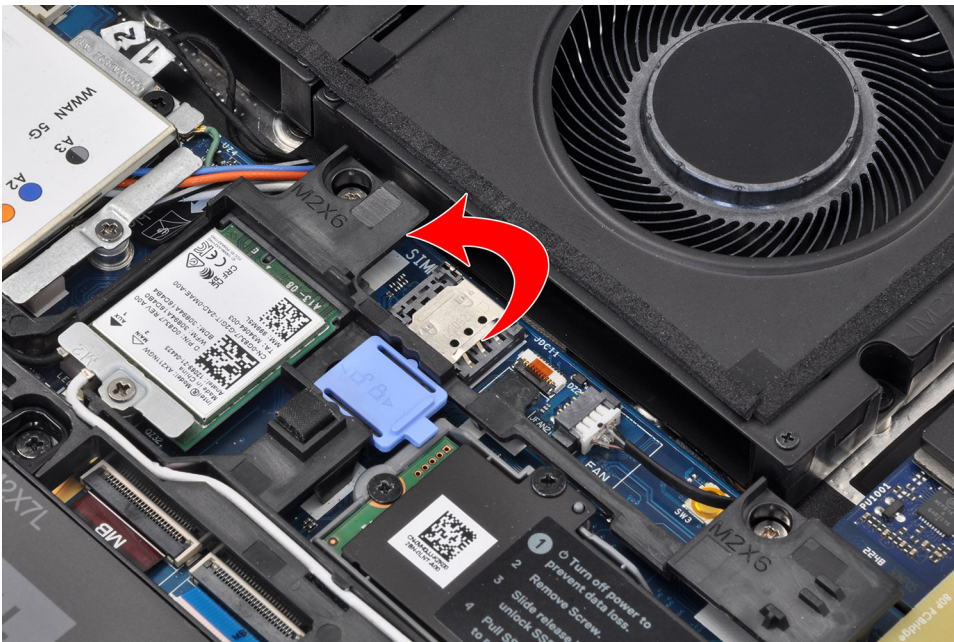

NOTE: The images that are shown above are of Precision 7780. The same information applies to Precision 7680.

3. Remove the SIM card from the SIM card slot.

Installing the SIM card

Prerequisites

If you are replacing a component, remove the existing component before performing the installation procedure.

About this task

The figure indicates the location of the SIM card and provides a visual representation of the installation procedure.

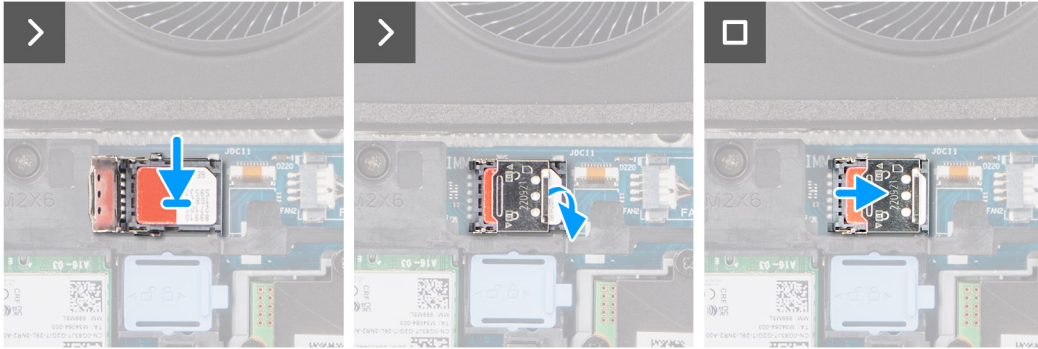
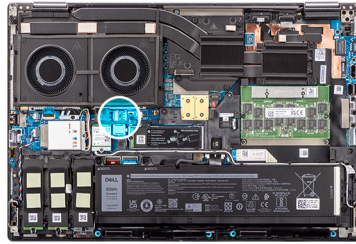

Steps

1. Place the SIM card into the SIM card slot.
2. Snap the SIM card cover down.
3. Slide the SIM card cover towards the right of the computer to lock the cover.

Next steps

1. Install the [base cover](#).
2. Follow the procedure in [after working inside your computer](#).

Compression Attached Memory (CAMM) module

Removing the Compression Attached Memory (CAMM) module

Prerequisites

1. Follow the procedure in [before working inside your computer](#).
2. Remove the [base cover](#).

About this task

 **NOTE:** For models shipped with a CAMM module

The figure indicates the location of the CAMM module and provides a visual representation of the removal procedure.

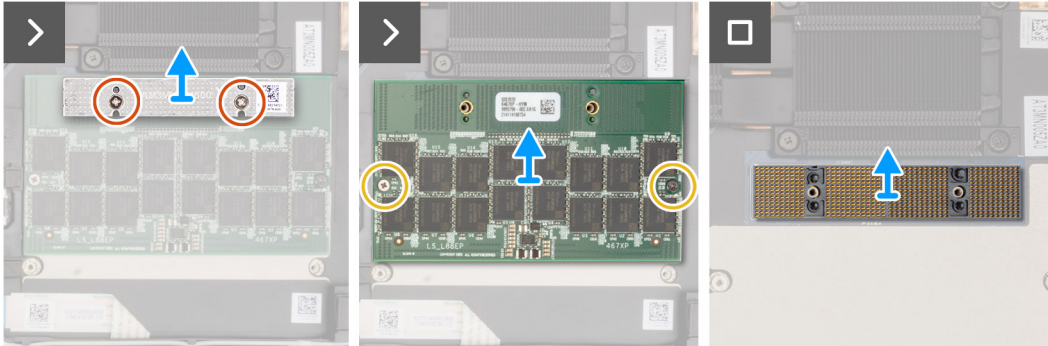
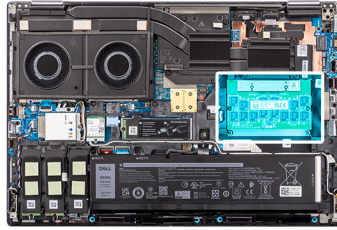
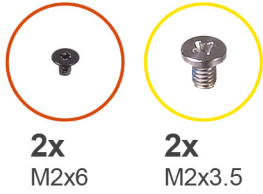

Steps

1. Remove the two (M2x6) screws that secure the memory bracket on the CAMM module.
2. Lift to remove the memory bracket.
3. Remove the two (M2x3.5) screws that secure the CAMM module to the system board.
4. Lift to remove the CAMM module and the CAMM connector module from the system board.

CAUTION: When handling the memory connector **DO NOT** touch the pins on the connector module, the pins are fragile and any direct contact with the pins may damage them. Only hold the connector from the sides to avoid contact with the pins.

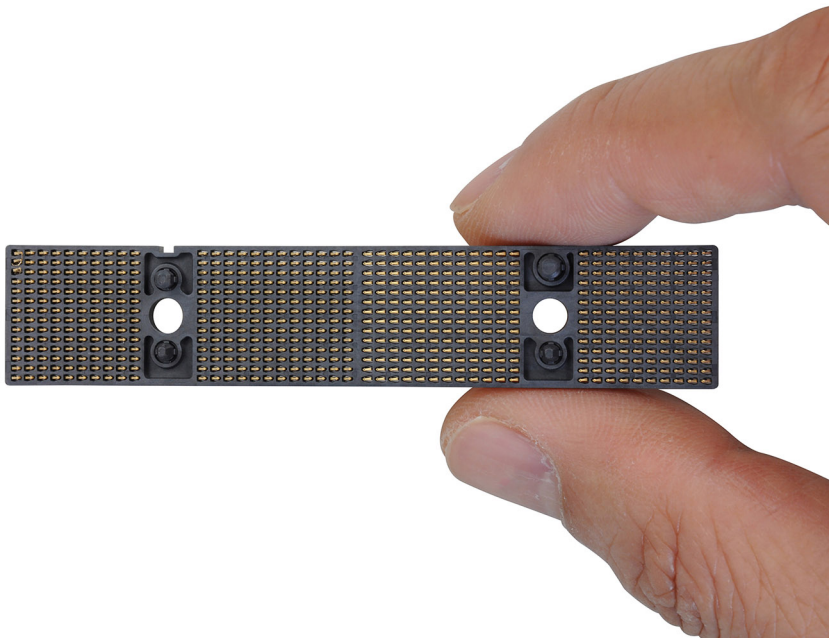

Installing the Compression Attached Memory (CAMM) module

Prerequisites

If you are replacing a component, remove the existing component before performing the installation procedure.

About this task

NOTE: For models shipped with a CAMM module

The figure indicates the location of the CAMM module and provides a visual representation of the installation procedure.

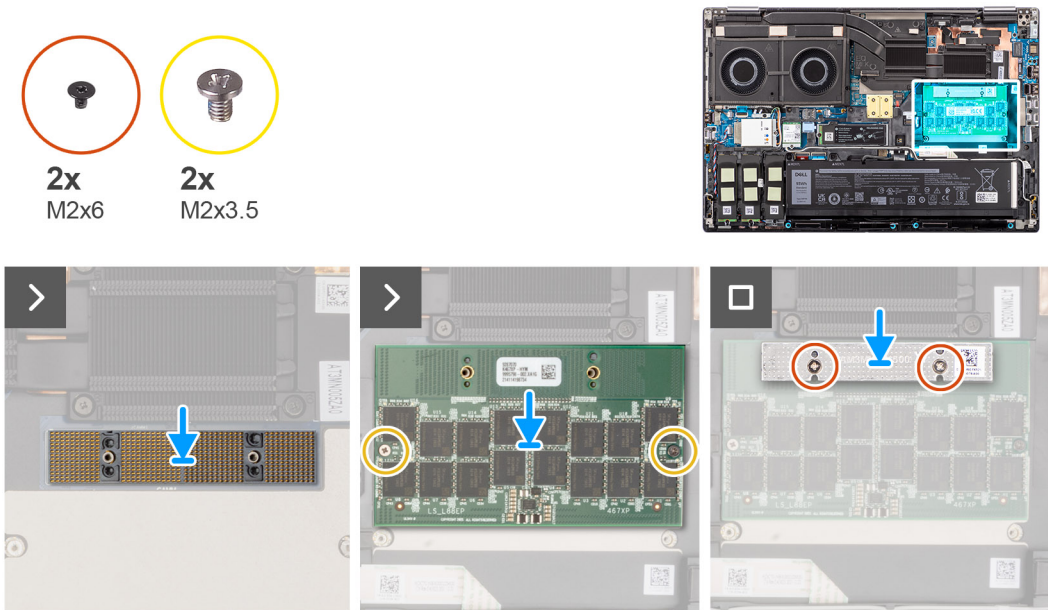

Steps

1. Place the CAMM connector module and the CAMM module into its slot on the system board.

CAUTION: When handling the memory connector DO NOT touch the pins on the connector module, the pins are fragile and any direct contact with the pins may damage them. Only hold the connector from the sides to avoid contact with the pins.

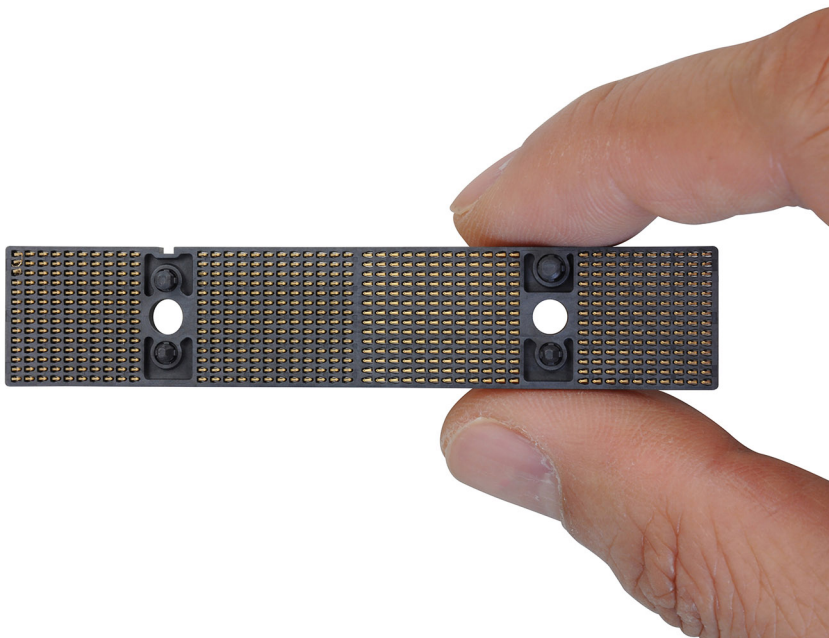

2. Replace the two (M2x3.5) screws to secure the CAMM module to the system board.
3. Place the memory bracket and replace the two (M2x6) screws to secure it to the CAMM module.

Next steps

1. Install the [base cover](#).

2. Follow the procedure in [after working inside your computer](#).

Memory modules

Removing the memory module

Prerequisites

1. Follow the procedure in [before working inside your computer](#).
2. Remove the [base cover](#).

About this task

NOTE: For models shipped with a SODIMM configuration.

The figure indicates the location of the memory module and provides a visual representation of the removal procedure.

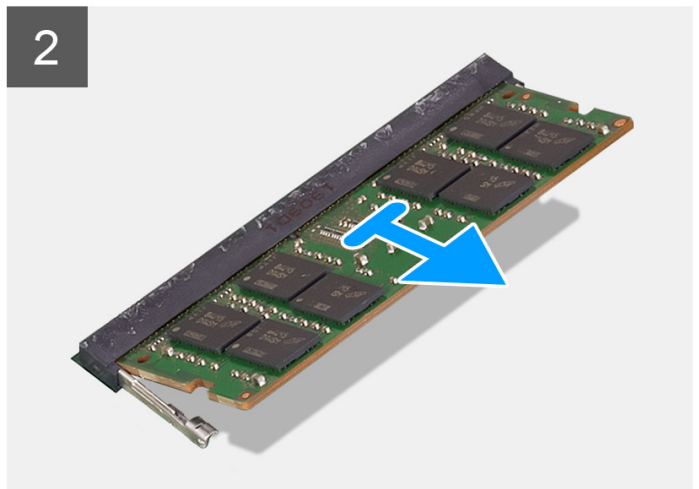
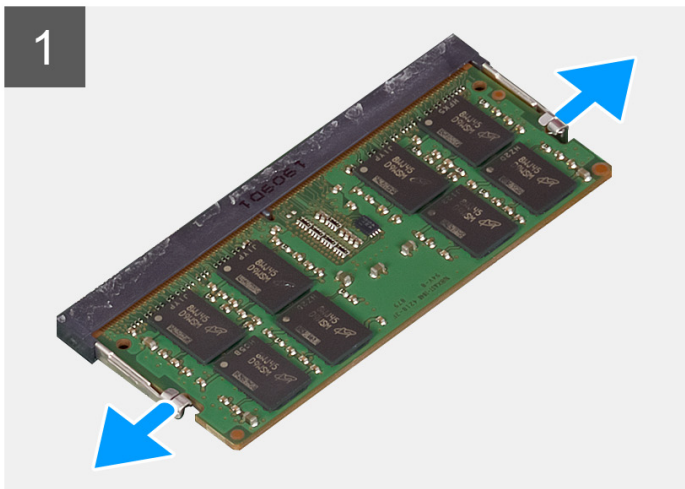
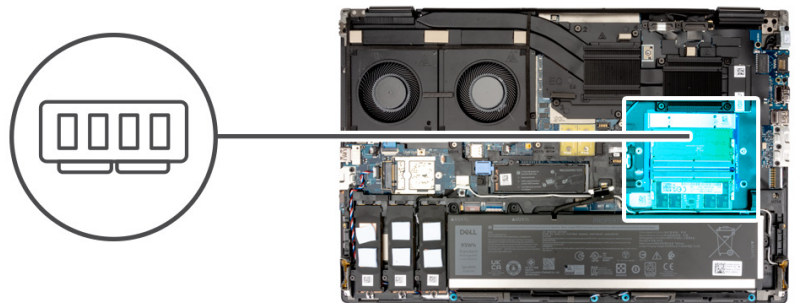

Steps

1. Pry the securing clips from both side of the memory module until the memory module pops up.
2. Remove the memory module from the memory-module slot.

NOTE: Repeat the above steps if there are other .

Installing the memory module

Prerequisites

If you are replacing a component, remove the existing component before performing the installation procedure.

About this task

i **NOTE:** For models shipped with a SODIMM configuration.

The figure indicates the location of the memory module and provides a visual representation of the installation procedure.

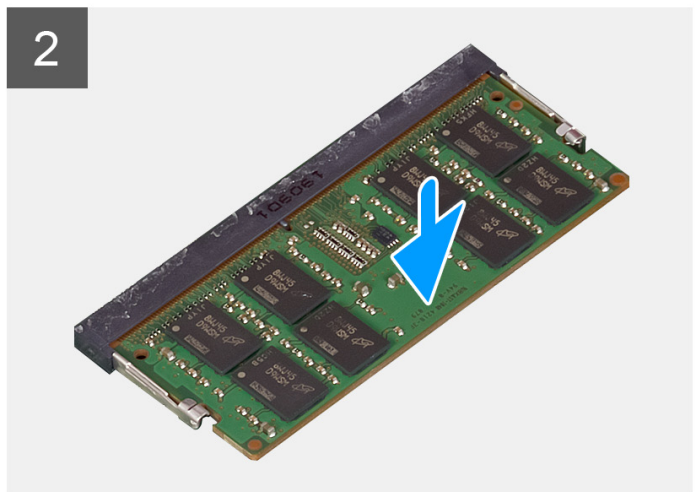
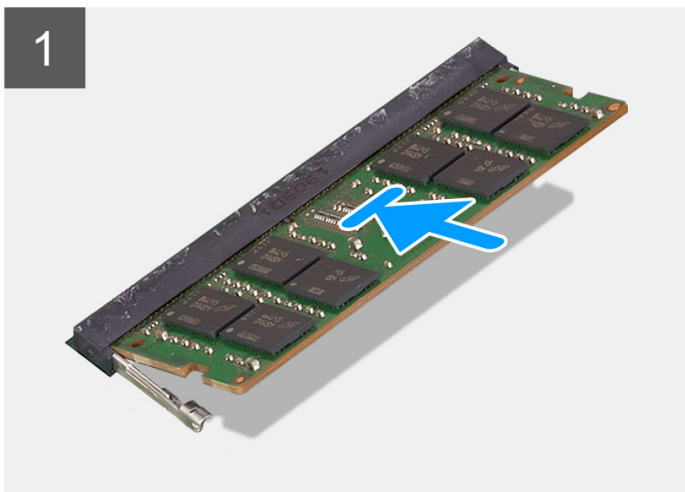
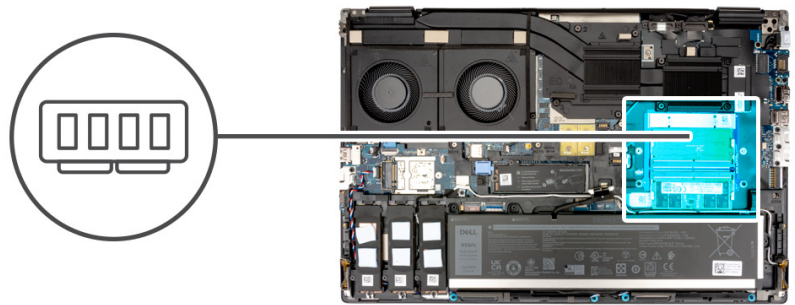

Steps

1. Align the notch on the memory module with the tab on the memory-module slot.
2. Slide the memory module firmly into the slot at an angle and press the memory module down until it clicks into place.

Next steps

1. Install the [base cover](#).
2. Follow the procedure in [after working inside your computer](#).

Memory interposer board

Removing the interposer board module

Prerequisites

1. Follow the procedure in [before working inside your computer](#).
2. Remove the [base cover](#).
3. Remove the [memory module](#).

About this task

i **NOTE:** For models shipped with a SODIMM configuration.

The figure indicates the location of the interposer board module and provides a visual representation of the removal procedure.



2x
M2x6



2x
M2x5

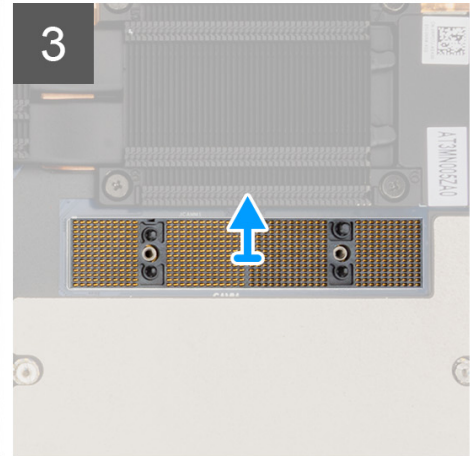
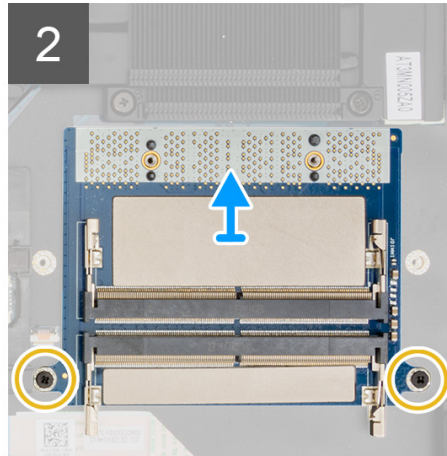
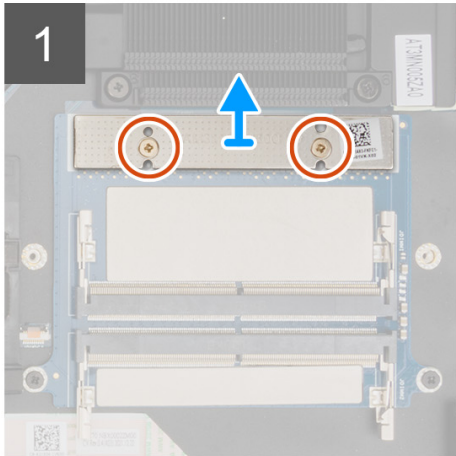
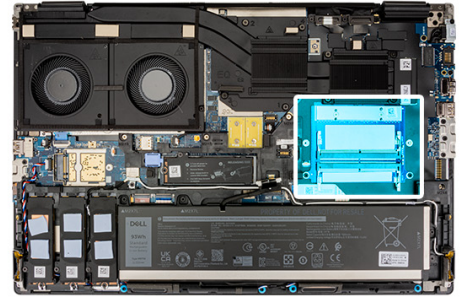

Steps

1. Remove the two (M2x6) screws that secure the memory bracket to the memory interposer board.
2. Lift the memory bracket off the memory interposer board.
3. Remove the two (M2x5) screws that secure the memory interposer board to the system board.
4. Lift to remove the memory interposer board from the system board.
5. Lift to remove the DIMM connector module from the system board.

CAUTION: When handling the memory connector DO NOT touch the pins on the connector module, the pins are fragile and any direct contact with the pins may damage them. Only hold the connector from the sides to avoid contact with the pins.

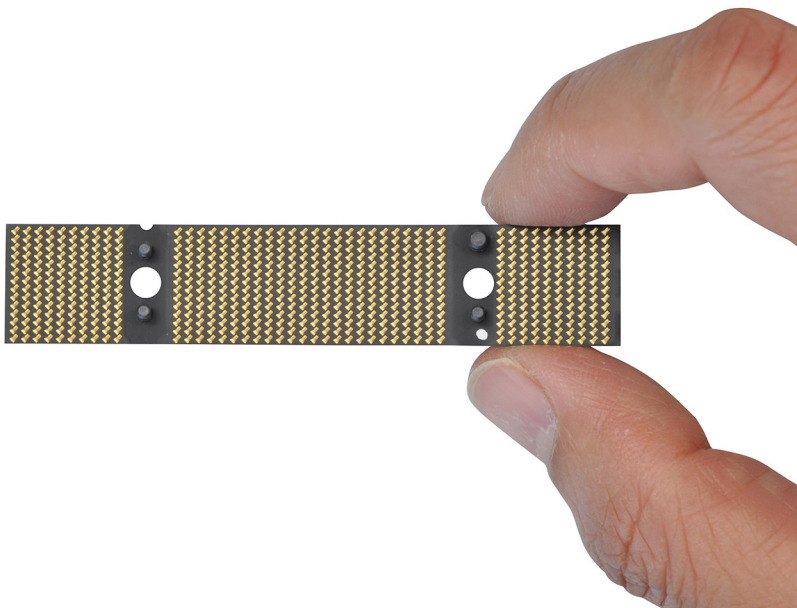

Installing the interposer board module

Prerequisites

If you are replacing a component, remove the existing component before performing the installation procedure.

About this task

NOTE: For models shipped with a SODIMM configuration.

The figure indicates the location of the interposer board module and provides a visual representation of the installation procedure.

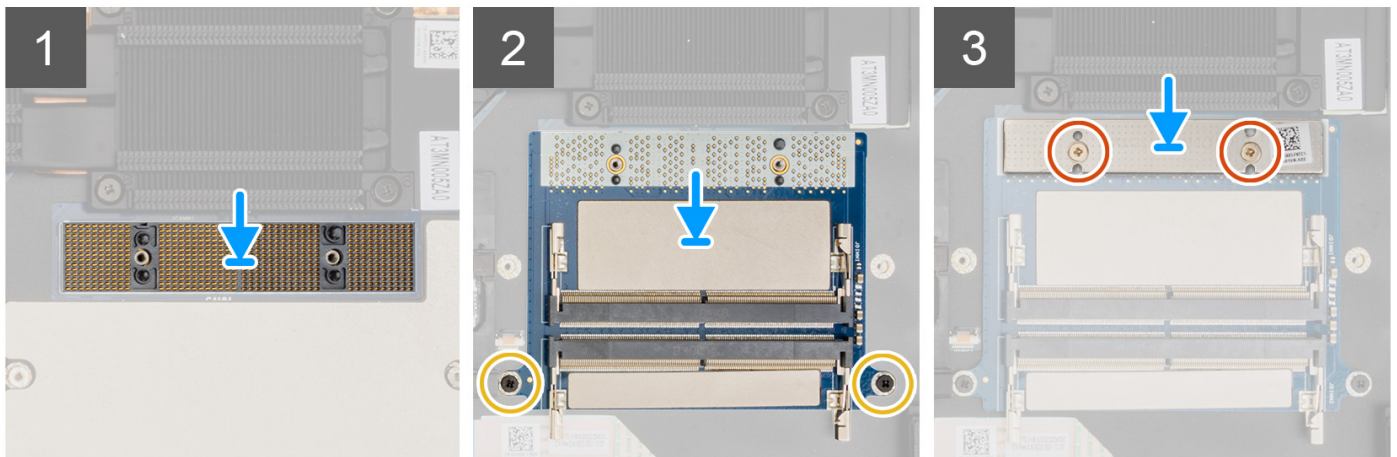
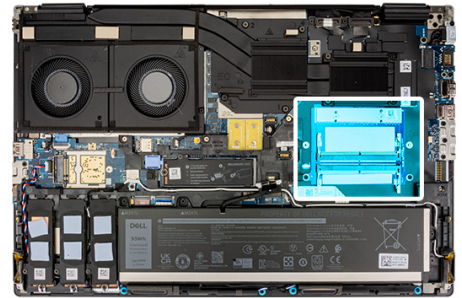

Steps

1. Place the DIMM connector module on the system board.

CAUTION: When handling the memory connector DO NOT touch the pins on the connector module, the pins are fragile and any direct contact with the pins may damage them. Only hold the connector from the sides to avoid contact with the pins.

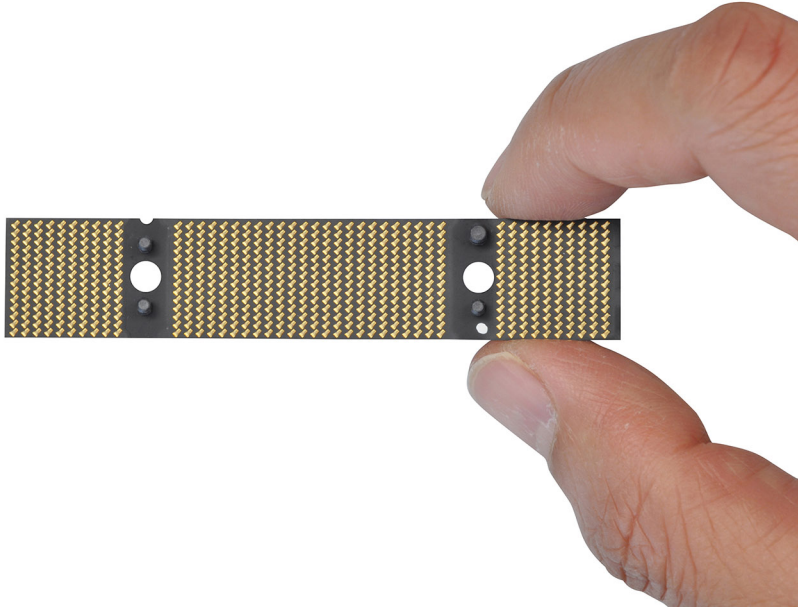

2. Place the memory interposer board on the system board.
3. Replace the two (M2x5) screws to secure the memory interposer board to the system board.
4. Place the memory bracket on the memory interposer board.
5. Replace the two (M2x6) screws to secure the memory bracket to the memory interposer board.

Next steps

1. Install the [memory module](#).
2. Install the [base cover](#).
3. Follow the procedure in [after working inside your computer](#).

WLAN card

Removing the WLAN card

Prerequisites

1. Follow the procedure in [before working inside your computer](#).
2. Remove the [base cover](#).

About this task

The figure indicates the location of the WLAN card and provides a visual representation of the removal procedure.



1x

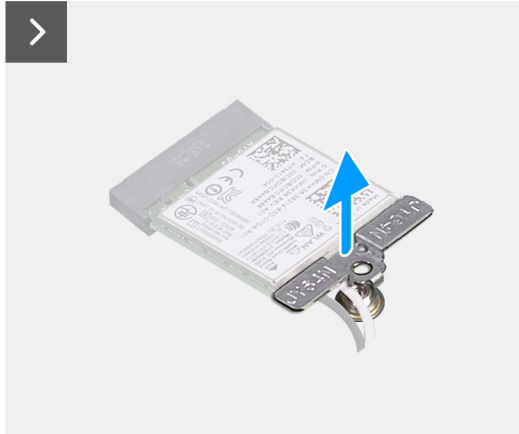
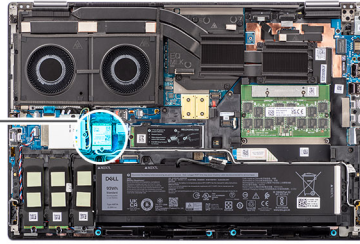

Steps

1. Remove the (M2x3) screw that secures the WLAN card bracket to the system board.
2. Remove the WLAN card bracket away from the WLAN card.
3. Disconnect the antenna cables from the WLAN card.
4. Slide at an angle and remove the WLAN card from the connector on the system board.

Installing the WLAN card

Prerequisites

If you are replacing a component, remove the existing component before performing the installation procedure.

About this task

The figure indicates the location of the WLAN card and provides a visual representation of the installation procedure.



1x

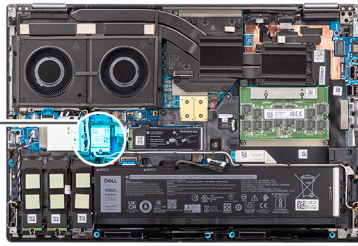

Steps

1. Connect the antenna cables to the WLAN card.

The following table provides the antenna-cable color scheme for the WLAN card of your computer.

Table 2. Antenna-cable color scheme

Connectors on the wireless card	Antenna-cable color
Main (white triangle)	White
Auxiliary (black triangle)	Black

2. Align the notch on the WLAN card with the WLAN connector and insert the WLAN card at an angle into the WLAN card slot.
3. Align and place the WLAN card bracket to secure the WLAN antenna cables to the WLAN card.
4. Replace the (M2x3) screw to secure the WLAN card bracket to the system board.

Next steps

1. Install the [base cover](#).
2. Follow the procedure in [after working inside your computer](#).

Wireless Wide Area Network (WWAN) card

Removing the WWAN card

Prerequisites

1. Follow the procedure in [before working inside your computer](#).
2. Remove the [base cover](#).

About this task

The figure indicates the location of the WWAN card and provides a visual representation of the removal procedure.

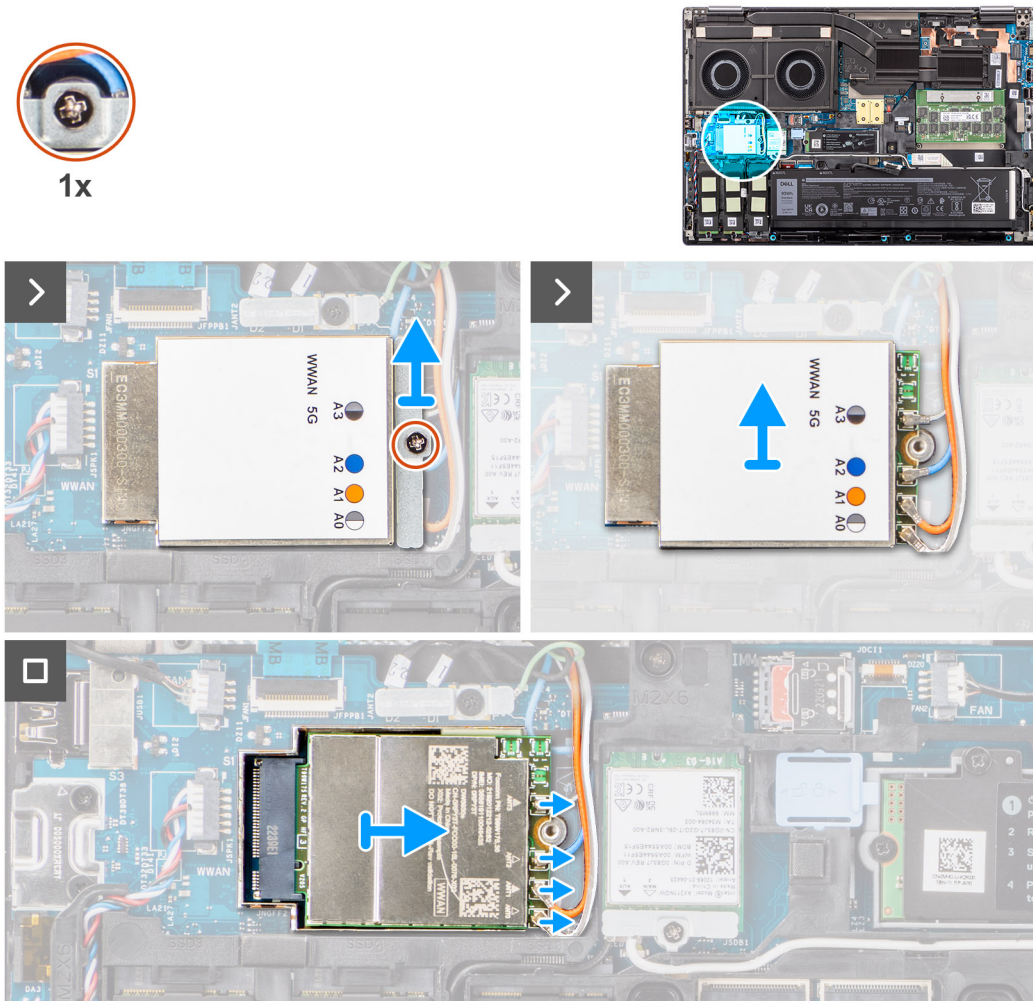

Steps

1. Remove the (M2x2) screw that secures the WWAN card bracket to the system board.
2. Lift the WWAN card bracket from the WWAN card.
3. Disconnect the antenna cables from the connector on the WWAN card.
4. Slide and remove the WWAN card from its slot on the system board.

i **NOTE:** When replacing the system board, the sticker indicating the WWAN antenna cable connections must be relocated to the replacement system board.

Installing the WWAN card

Prerequisites

If you are replacing a component, remove the existing component before performing the installation procedure.

About this task

The figure indicates the location of the WWAN card and provides a visual representation of the installation procedure.



1x

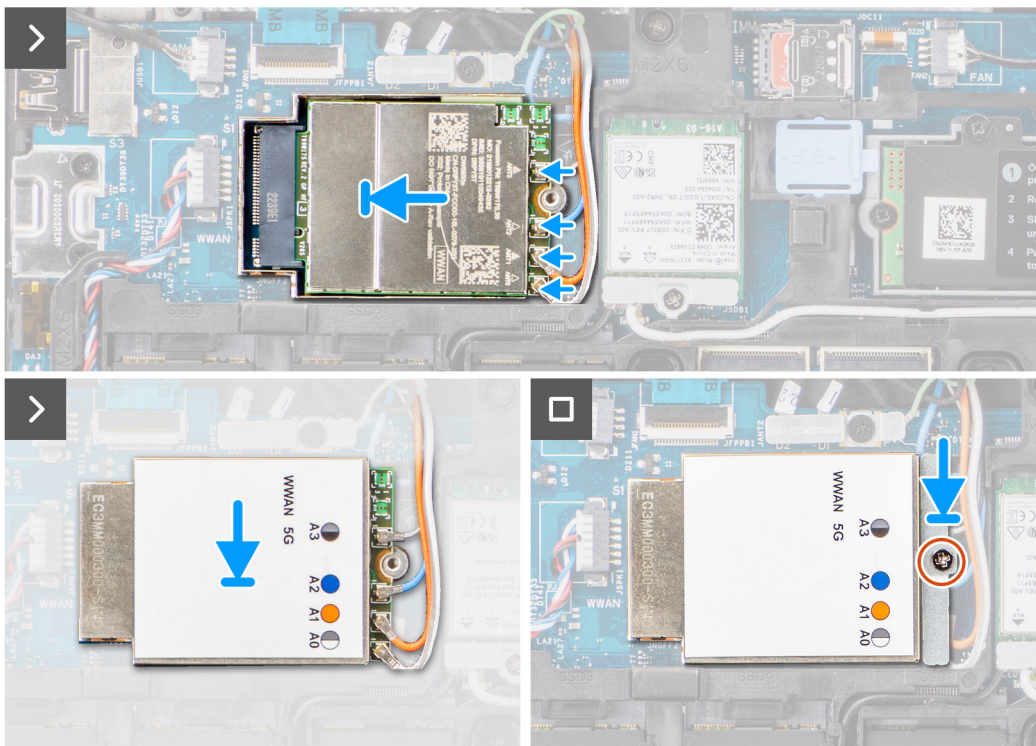
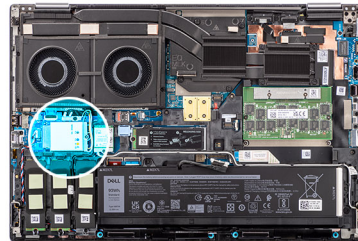

Steps

1. Connect the antenna cables to the connectors on the WWAN card. The following table provides the antenna-cable color scheme for the WWAN card of your computer.

Table 3. Antenna-cable color scheme

Antenna Cable Color	Pin Definition
White/Grey	ANT0
Orange	ANT1
Blue	ANT2
Black/Grey	ANT3

The connections are also printed on the WWAN card slot.

2. Align and slide the WWAN card to its slot on the system board.

3. Place the WWAN card bracket above the WWAN card to secure the antenna cables.
4. Replace the (M2x2) screw to secure the WWAN card bracket to the system board.

 **NOTE:** For instructions on how to find your computer's IMEI (International Mobile Station Equipment Identity) number, see the knowledge base article [000143678](https://www.dell.com/support/000143678) at <https://www.dell.com/support/>.

Next steps

1. Install the [base cover](#).
2. Follow the procedure in [after working inside your computer](#).

Solid State Drive

Removing the primary M.2 Solid-state drive

Prerequisites

 **NOTE:** For computers shipped with M.2 2280 or 2230 Solid-state drive that is installed in slot 5.

1. Follow the procedure in [before working inside your computer](#).
2. Remove the [base cover](#).

 **NOTE:** Follow this procedure only if the computer is shipped without SSD door configuration).

About this task

The figure indicates the location of the primary M.2 SSD and provides a visual representation of the removal procedure.



2x
M2x2.5

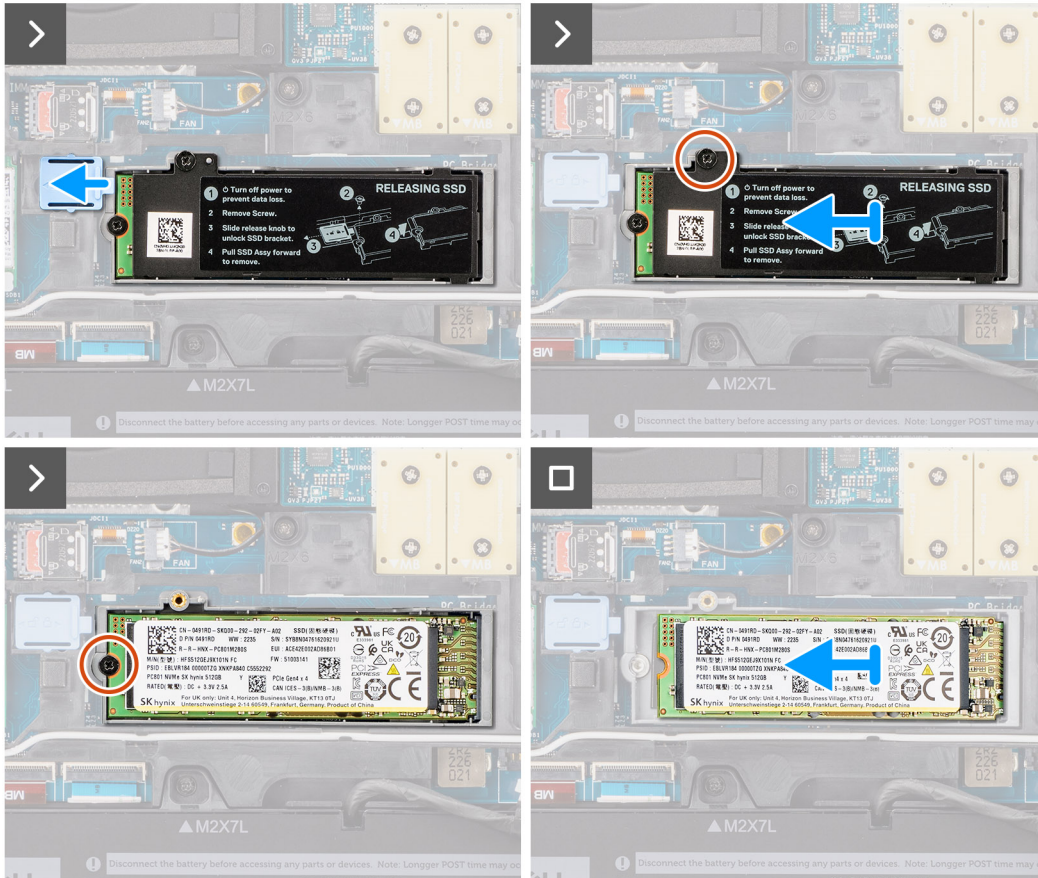
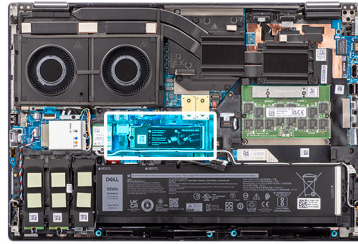

Steps

1. Slide the SSD release latch into the unlock position and remove the (M2x2.5) screw that secures the SSD thermal plate to the SSD carrier.
2. Lift to remove the SSD thermal plate.
3. Remove the (M2x2.5) screw that secures the SSD to the system chassis.
4. Lift to remove the SSD from the system chassis.

Installing the primary M.2 SSD module

Prerequisites

NOTE: For computers shipped with M.2 2280 or 2230 Solid-state drive that is installed in slot 5.

If you are replacing a component, remove the existing component before performing the installation procedure.

About this task

The figure indicates the location of the primary M.2 SSD and provides a visual representation of the installation procedure.



2x
M2x2.5

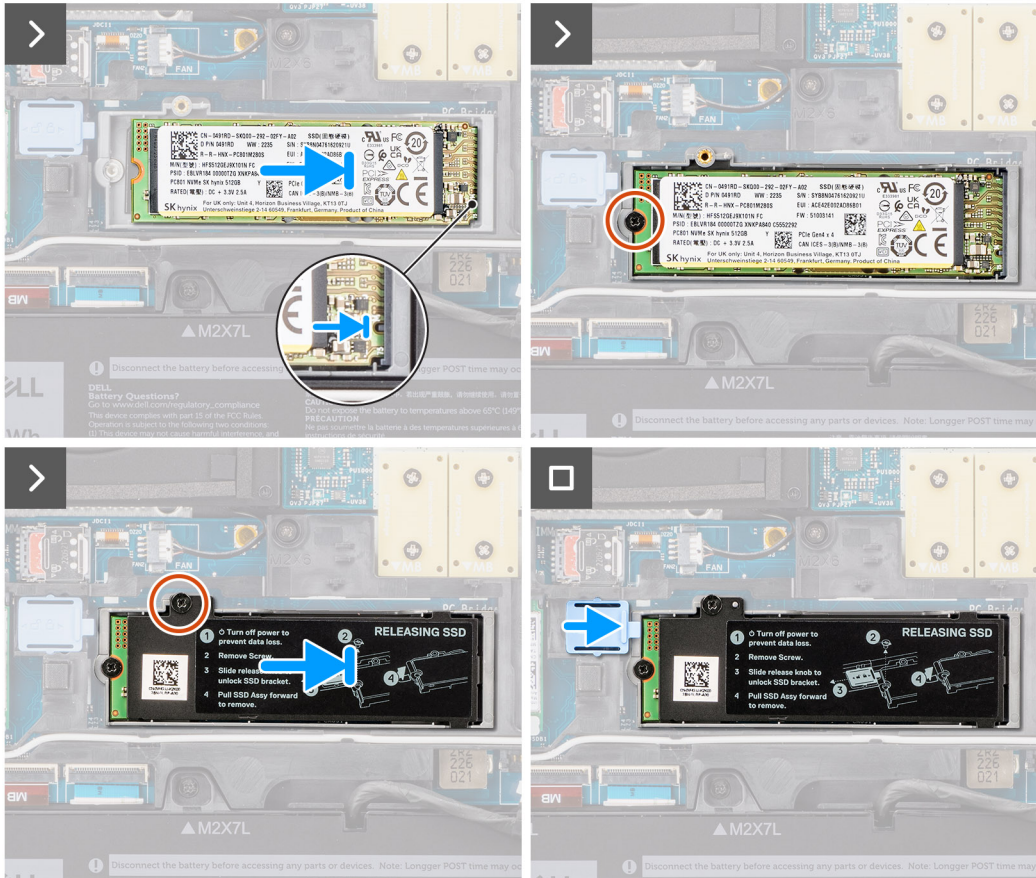
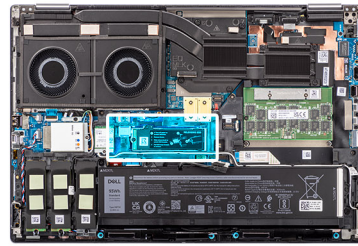

Steps

1. Place the SSD onto its slot on the system chassis.
2. Replace the (M2x2.5) screw to secure the SSD to the system chassis.
3. Replace the (M2x2.5) screw to secure the SSD thermal plate to the SSD carrier and slide the SSD release latch into the lock position.

Next steps

1. Install the [base cover](#).
2. Follow the procedure in [after working inside your computer](#).

Secondary M.2 solid-state drive

Removing the secondary M.2 Solid-state drive

Prerequisites

 **NOTE:** For computers shipped with M.2 2280 PCIe Gen4 SSD installed in slot 4, 2, 3 and 5.

1. Follow the procedure in [before working inside your computer](#).
2. Remove the [base cover](#).

 **NOTE:** Follow this procedure only if the computer is shipped without SSD door configuration).

About this task

The figure indicates the location of the secondary M.2 SSD and provides a visual representation of the removal procedure.

For computers with SSD door configuration - Slot 5



2x
M2x2.5

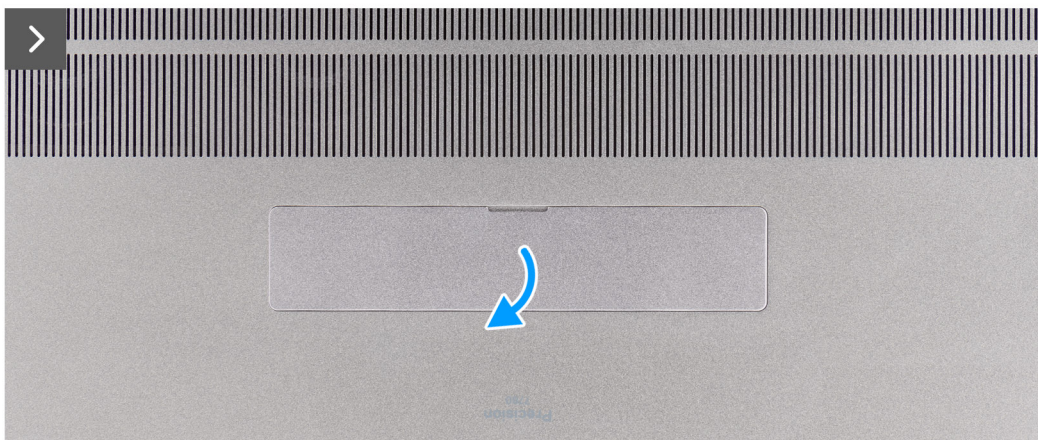

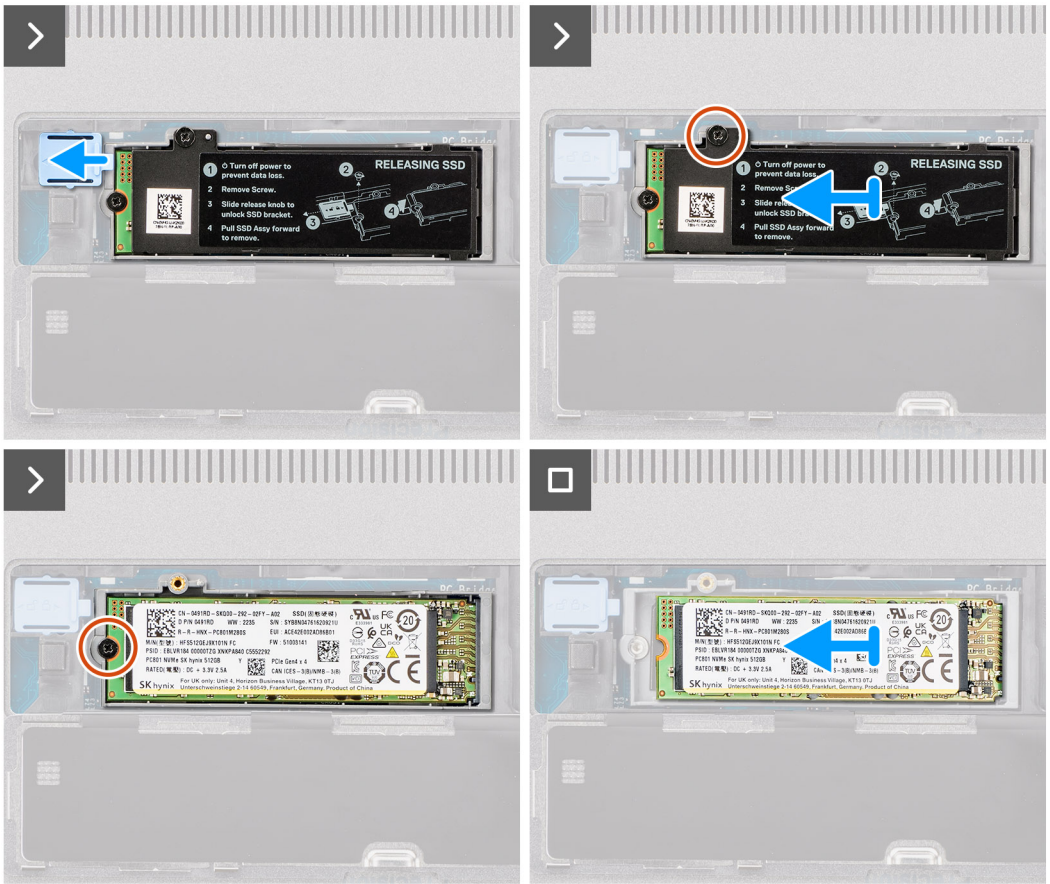

For computers without SSD door configuration

Slot-2



2x
M2x2.5

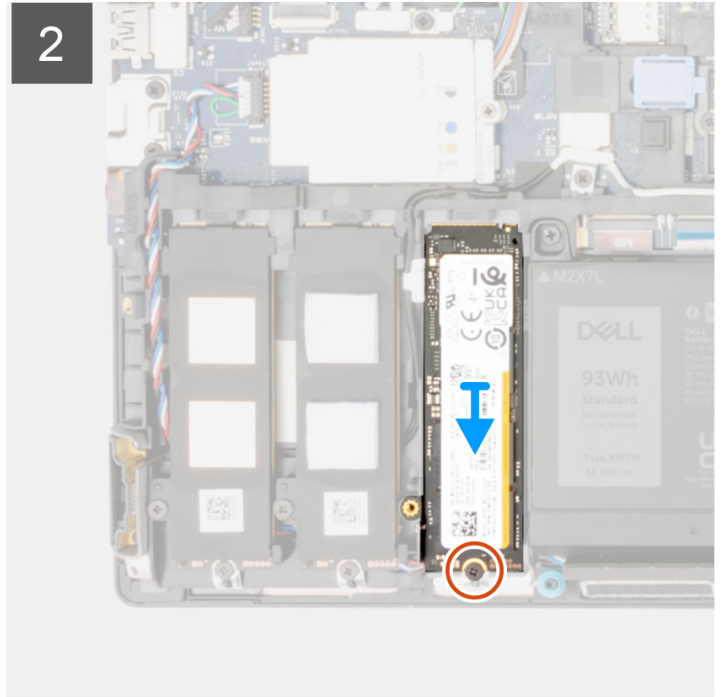
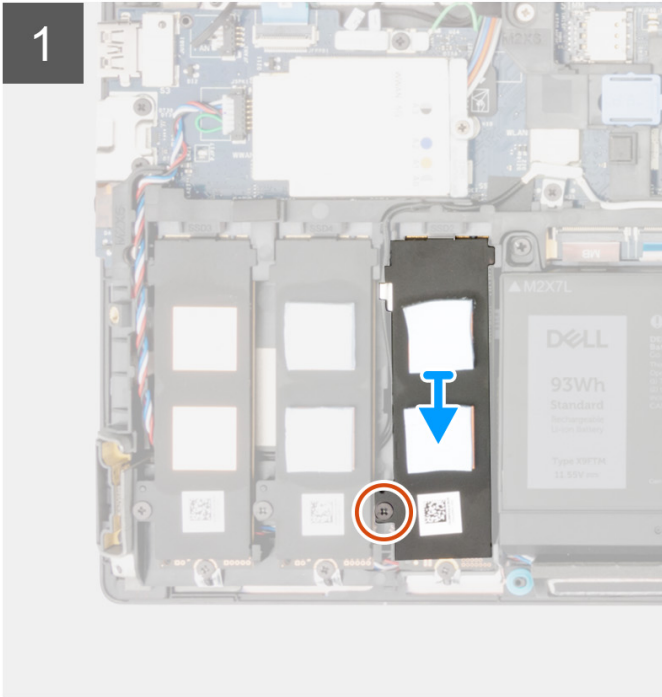
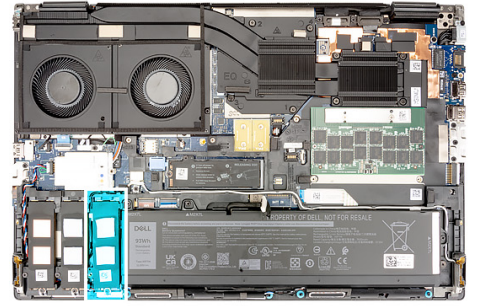

Slot - 3



2x
M2x2.5

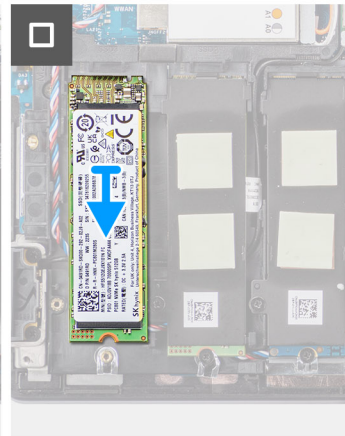
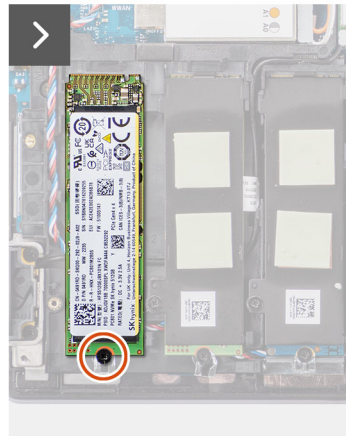
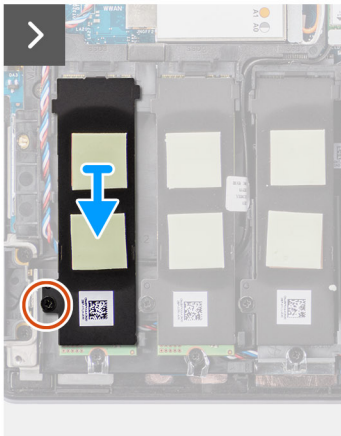
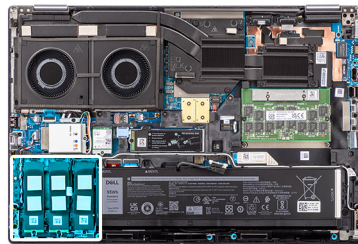

Slot - 4



2x
M2x2.5

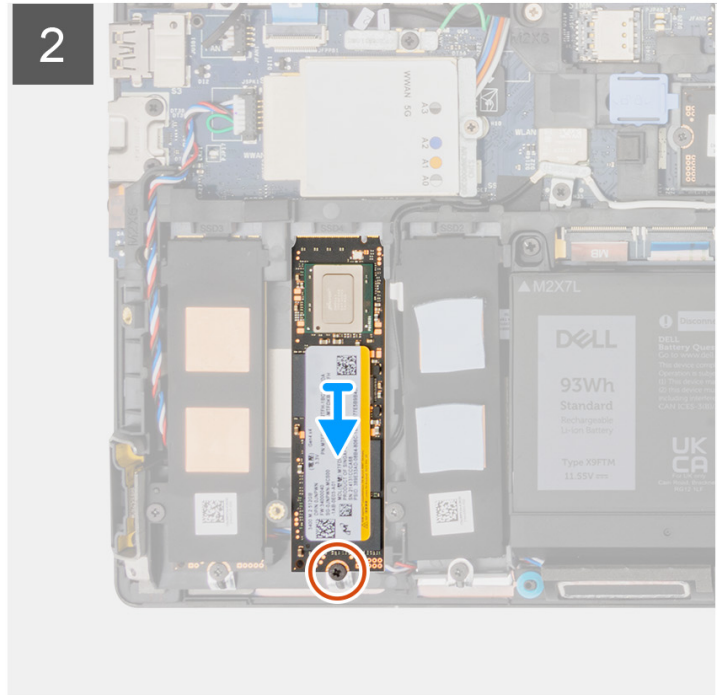
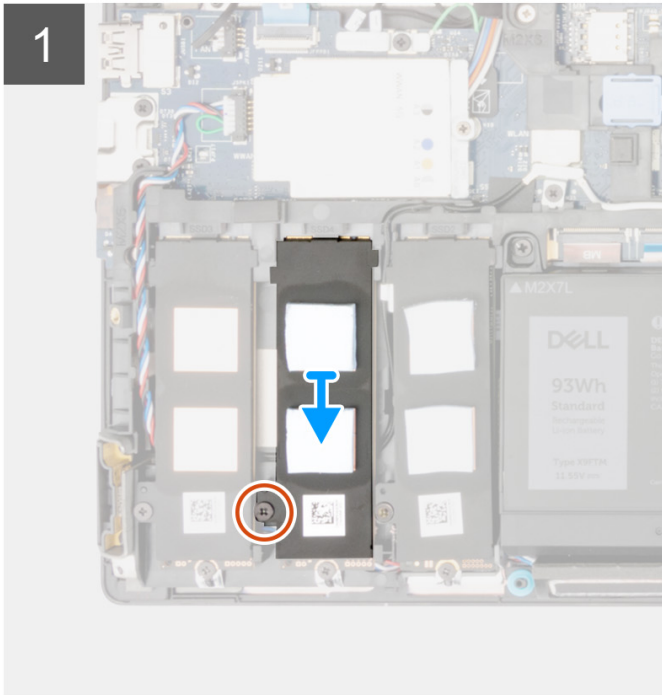
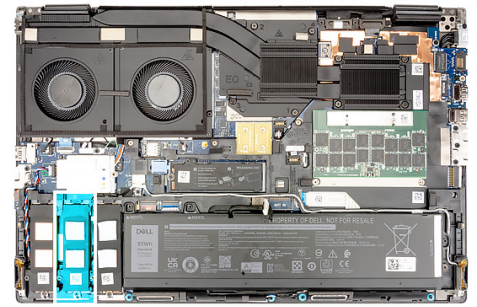

Steps

1. For computers with SSD door configuration:
 - a. Use a plastic scribe to pry open the SSD door from its recess point.
i **NOTE:** The SSD door is attached to the base cover from one side and cannot be detached.
 - b. Slide the SSD release latch to unlock the SSD module.
 - c. Follow the procedure from Step 3 to Step 7.
2. For computers without SSD door configuration:
 - a. Follow the procedure from Step 3 to Step 7.
3. Remove the (M2x2.5) screw that secures the SSD thermal plate to the chassis.
4. Carefully tilt at an angle and then slide to remove the SSD thermal plate from the SSD module.
5. Remove the (M2x2.5) screw that secures the SSD module into its slot on the computer.
6. Remove the SSD module from the chassis.

Installing the secondary M.2 SSD module

Prerequisites

- i** **NOTE:** For computers shipped with M.2 2280 PCIe Gen4 SSD installed in slot 4, 2, 3 and 5.

If you are replacing a component, remove the existing component before performing the installation procedure.

About this task

The figure indicates the location of the secondary M.2 SSD and provides a visual representation of the installation procedure.

For computers with SSD door configuration - Slot 5



2x
M2x2.5

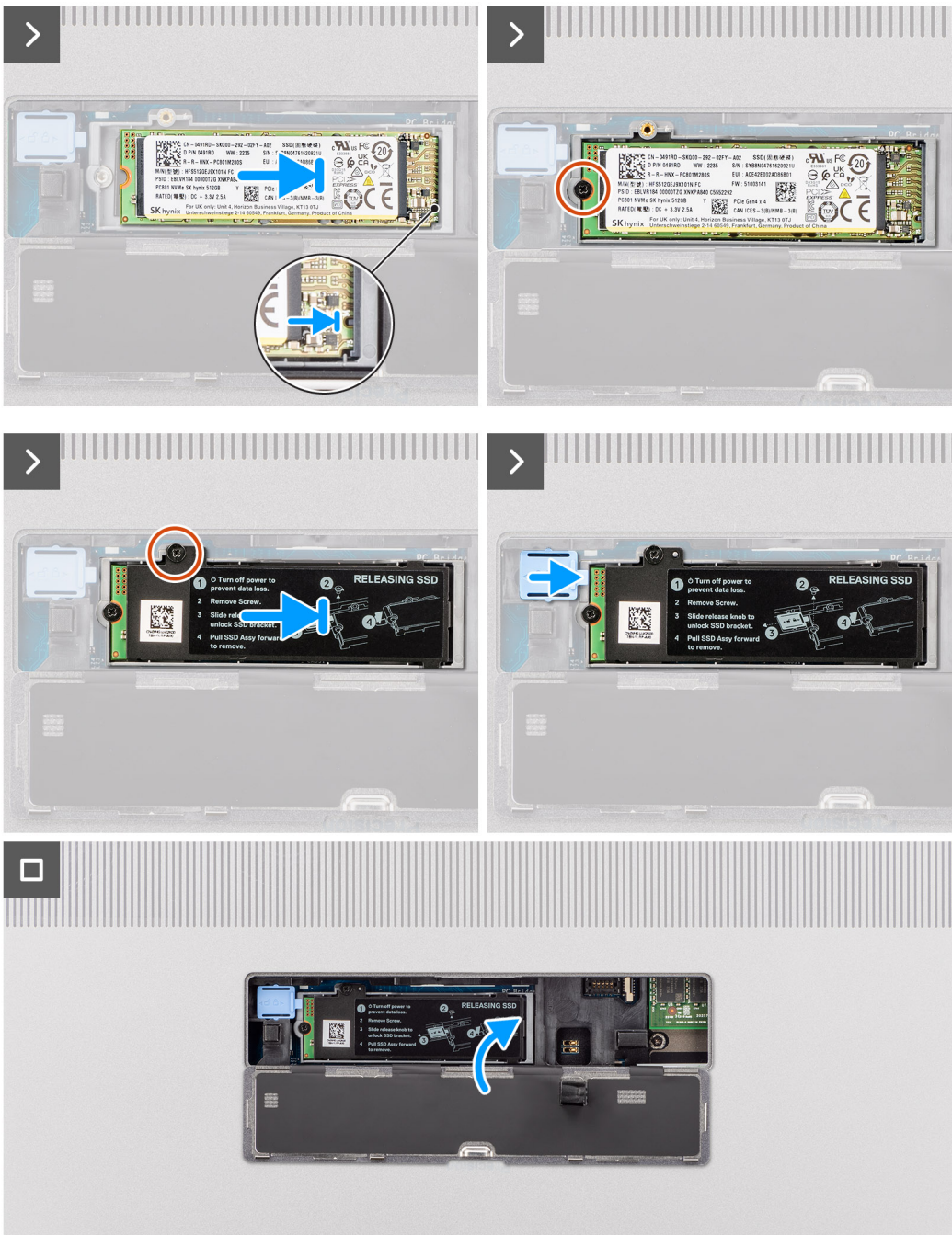

For computers without SSD door configuration

Slot-2



2x
M2x2.5

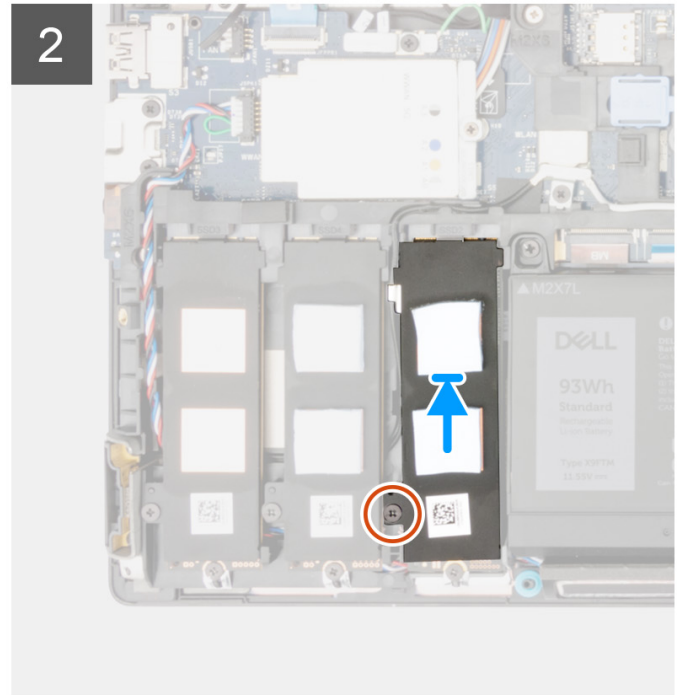
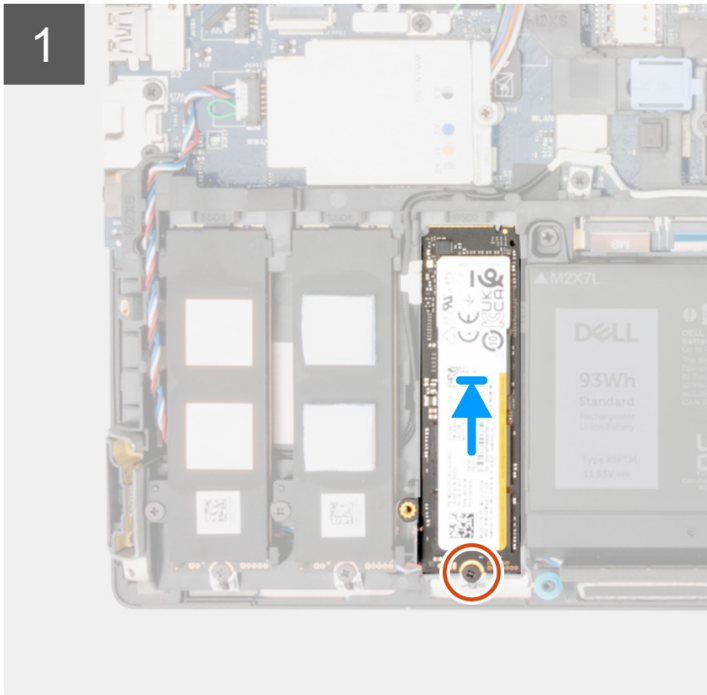
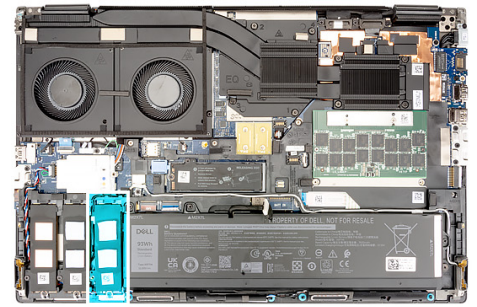

Slot - 3



2x
M2x2.5

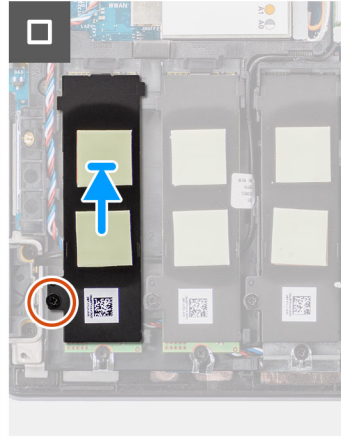
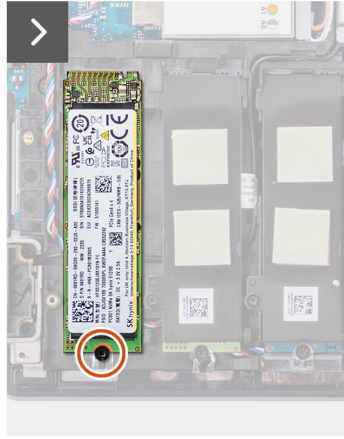
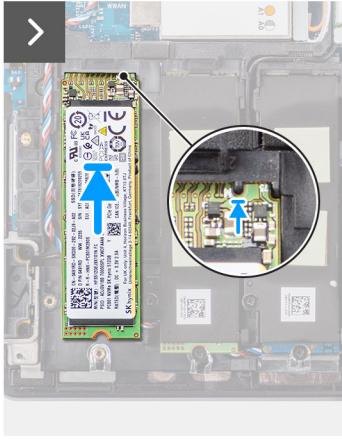
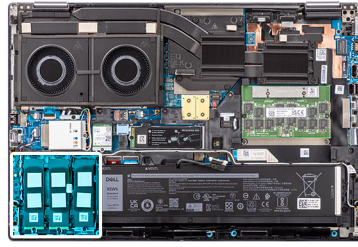

Slot - 4



2x
M2x2.5

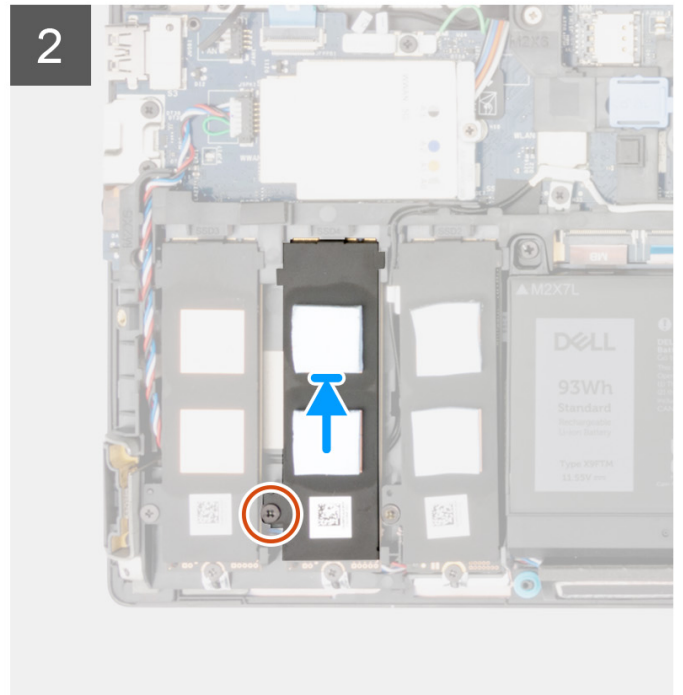
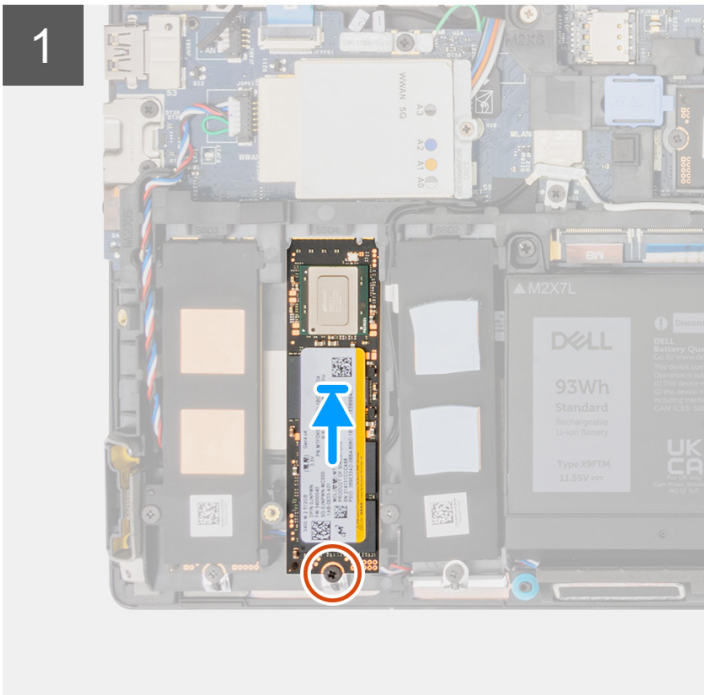
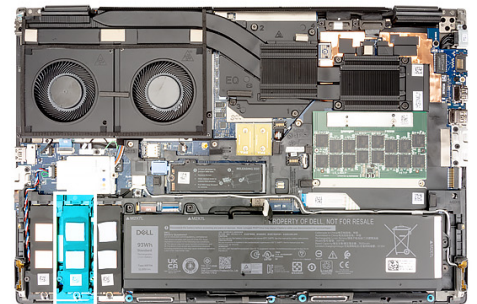

Steps

1. Place the M.2 2280 SSD onto its slot on the SSD carrier.
2. Replace the M.2 SSD module in its slot on the computer.
3. Replace the (M2x2.5) screw to secure the SSD module in place.
4. Align the tabs on the SSD thermal plate with the tab holes on the SSD carrier at an angle.
5. Place the SSD thermal plate above the M.2 SSD module.

i | **NOTE:** Carefully align the tab hole on the thermal plate near the screw hole with the tab on the SSD carrier.

6. Replace the (M2x2.5) screw to secure the SSD thermal plate to the M.2 SSD module.
7. For computers shipped with SSD door configuration:
 - a. Slide the SSD release latch to lock the SSD module in place.
 - b. Close the SSD door until it clicks into place.

Next steps

1. Install the [base cover](#).

i | **NOTE:** Follow this procedure only if the computer is shipped without SSD door configuration).

2. Follow the procedure in [after working inside your computer](#).

Heat sink

Removing the heat sink for discrete graphics

Prerequisites

1. Follow the procedure in [Before working inside your computer](#).
2. Remove the [base cover](#).

About this task

The figure indicates the location of the heat sink and provides a visual representation of the removal procedure.

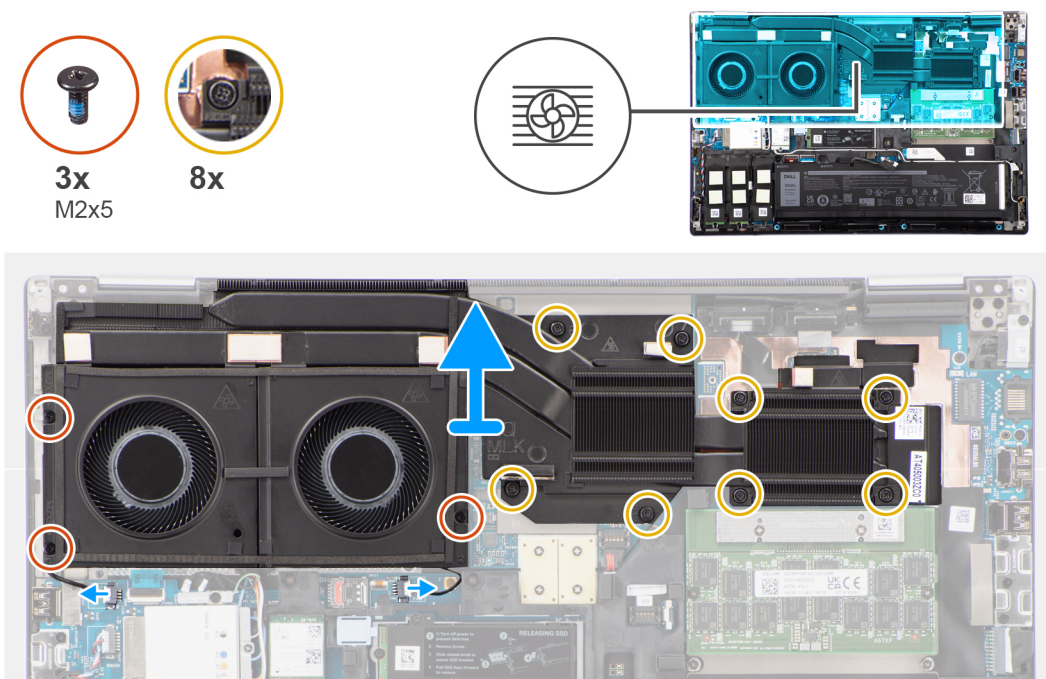

Steps

1. Disconnect the two fan cables from their connectors on the system board.
2. Remove the three (M2x5) screws that secure the fans to the system chassis.
3. Loosen the eight captive screws that secure the heat sink to the system board.

i **NOTE:** Loosen the captive screws in the order that is stamped onto the heat sink next to the screws [8 > 7 > 6 > 5 > 4 > 3 > 2 > 1].

4. Carefully lift the heat sink to remove it from the computer.

Installing the heat sink for discrete graphics

Prerequisites

If you are replacing a component, remove the existing component before performing the installation procedure.

About this task

The figure indicates the location of the heat sink and provides a visual representation of the installation procedure.

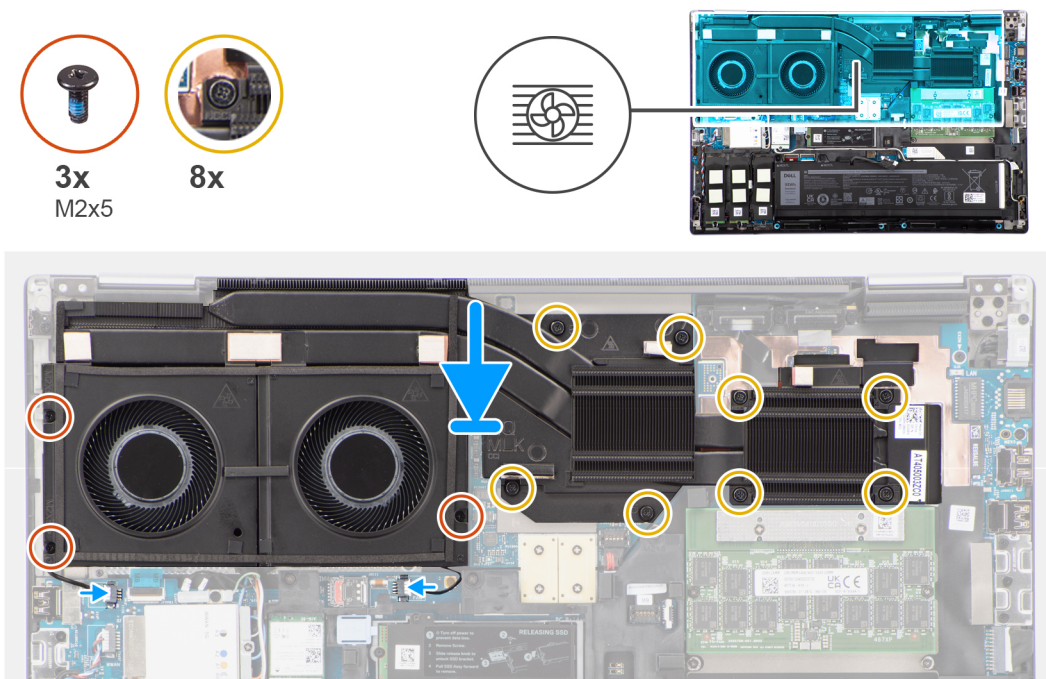

Steps

1. Align and insert the heat sink into its slot on the computer.
2. Tighten the eight captive screws to secure the heat sink to the system board.

i **NOTE:** Tighten the captive screws in the order that is stamped onto the heat sink next to the screws [1 > 2 > 3 > 4 > 5 > 6 > 7 > 8].

3. Replace the three (M2x5) screws to secure the fans to the system chassis.
4. Connect the two fan cables to their connectors on the system board.

Next steps

1. Install the [base cover](#).
2. Follow the procedure in [After working inside your computer](#).

GPU card

Removing the GPU card

Prerequisites

1. Follow the procedure in [before working inside your computer](#).
2. Remove the [base cover](#).
3. Remove the [heat-sink for discrete graphics](#).

About this task

The figure indicates the location of the GPU card and provides a visual representation of the removal procedure.

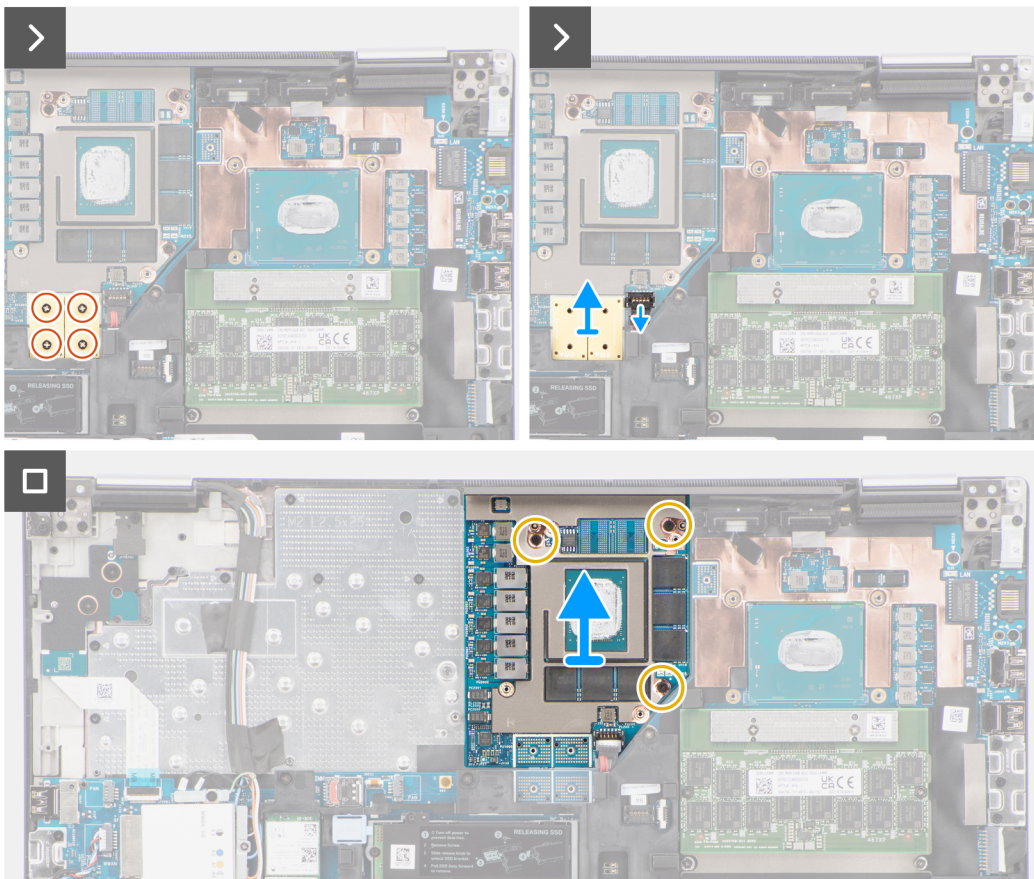
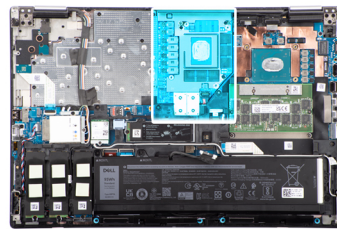

Steps

1. Carefully pry up the outside-end of the GPU power cable connector head to unlock the GPU power cable connector from the GPU card.
2. Slightly slide the GPU power cable connector outwards to disconnect the GPU power cable from the GPU card.
3. Remove the four (M2x6) screws that secure the PCB beam connectors on the system board.

4. Lift to remove the PCB beam connectors from the system board.
5. Remove the three (M2x5) screws that secure the GPU card to the system chassis.
6. Remove the GPU card from the computer.

Installing the GPU card

Prerequisites

If you are replacing a component, remove the existing component before performing the installation procedure.

About this task

The figure indicates the location of the GPU card and provides a visual representation of the installation procedure.

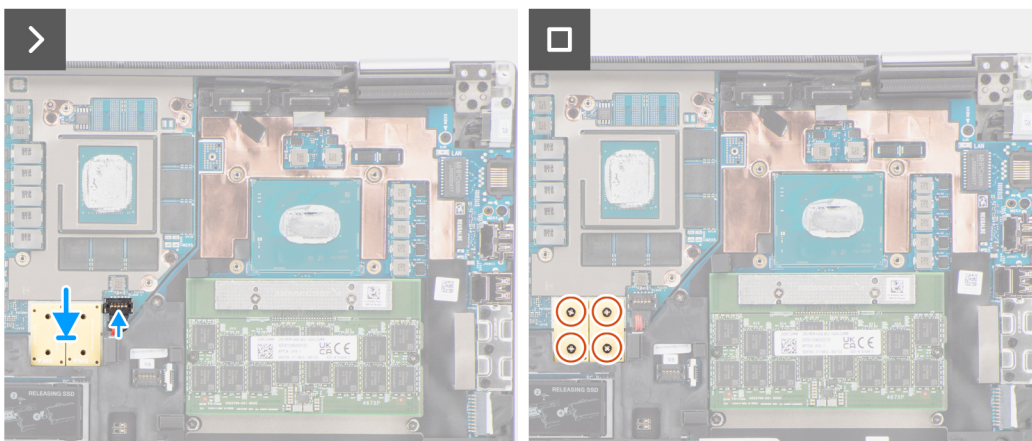
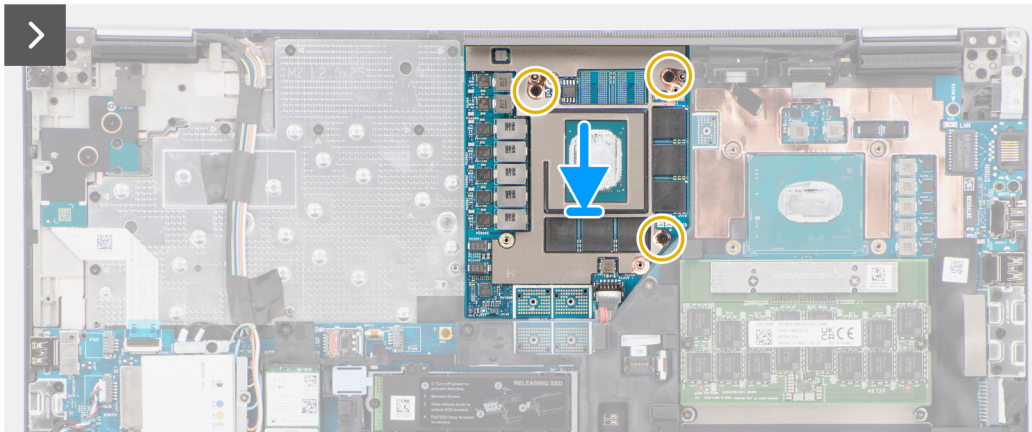
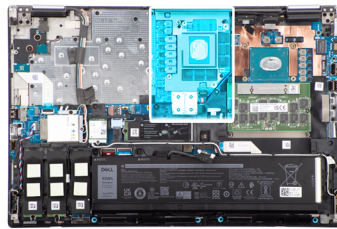

Steps

1. Align and place the GPU card into its slot on the system chassis.
2. Replace the three (M2x5) screws to secure the GPU card to the system chassis.
3. Align and place the PCB beam connectors on the system board.

NOTE: When installing an FPC beam connector, ensure that the end marked "MB" is connected to the system board and that the alignment pins on the connector are inserted into the openings on the boards.

4. Replace the four (M2x6) screws that secure the PCB beam connectors on the system board.
5. Slide the GPU power cable connector into its slot to connect the GPU power cable to the GPU card.
6. Lock the GPU power cable connector to secure the GPU card.

Next steps

1. Install the [heat-sink for discrete graphics](#).
2. Install the [base cover](#).
3. Follow the procedure in [after working inside your computer](#).

GPU power cable

Removing the GPU power cable

Prerequisites

1. Follow the procedure in [before working inside your computer](#).
2. Remove the [base cover](#).
3. Remove the [heat-sink for discrete graphics](#).

About this task

The figure indicates the location of the GPU power cable and provides a visual representation of the removal procedure.

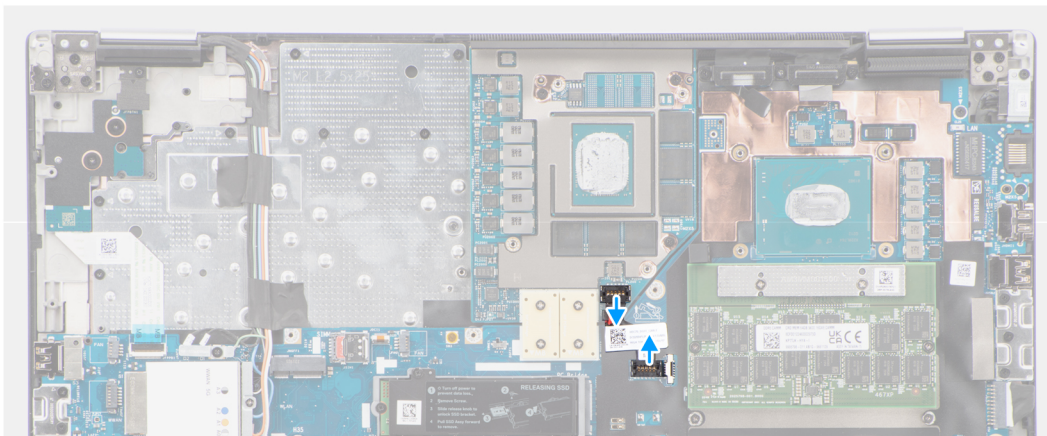
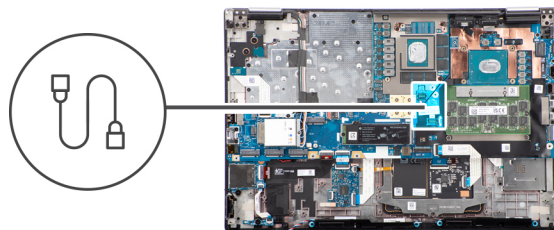

Steps

1. Carefully pry the outside end of the GPU power cable connector head to unlock the GPU power cable connector from the GPU card.
2. Slightly slide the GPU power cable connector outwards to disconnect the GPU power cable from the GPU card.
3. Repeat the above steps to disconnect the GPU power cable from the system board.
4. Peel the GPU power cable from the computer.

Installing the GPU power cable

Prerequisites

If you are replacing a component, remove the existing component before performing the installation procedure.

About this task

The figure indicates the location of the GPU power cable and provides a visual representation of the installation procedure.

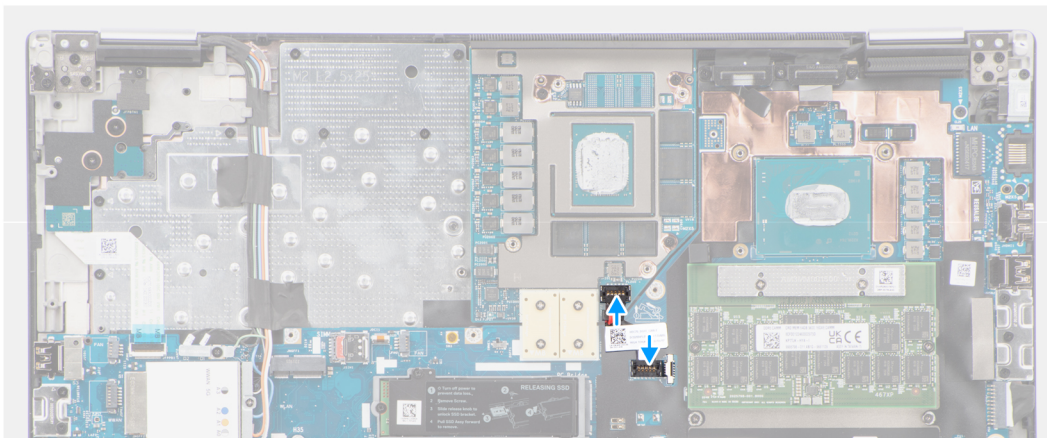
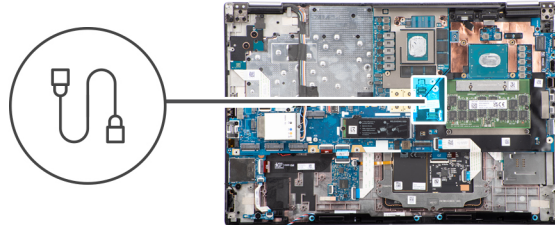

Steps

1. Adhere the GPU power cable into its slot on the computer.
2. Connect the GPU power cable from the connector on the system board.
3. Slide the GPU power cable connector into its slot to connect the GPU power cable to the GPU card.
4. Lock the GPU power cable connector to secure the GPU card.

Next steps

1. Install the [heat-sink for discrete graphics](#).
2. Install the [base cover](#).
3. Follow the procedure in [after working inside your computer](#).

Power button board

Removing the power button board

Prerequisites

1. Follow the procedure in [before working inside your computer](#).
2. Remove the [base cover](#).
3. Remove the [heat-sink for discrete graphics](#).

About this task

The figure indicates the location of the power button board and provides a visual representation of the removal procedure.

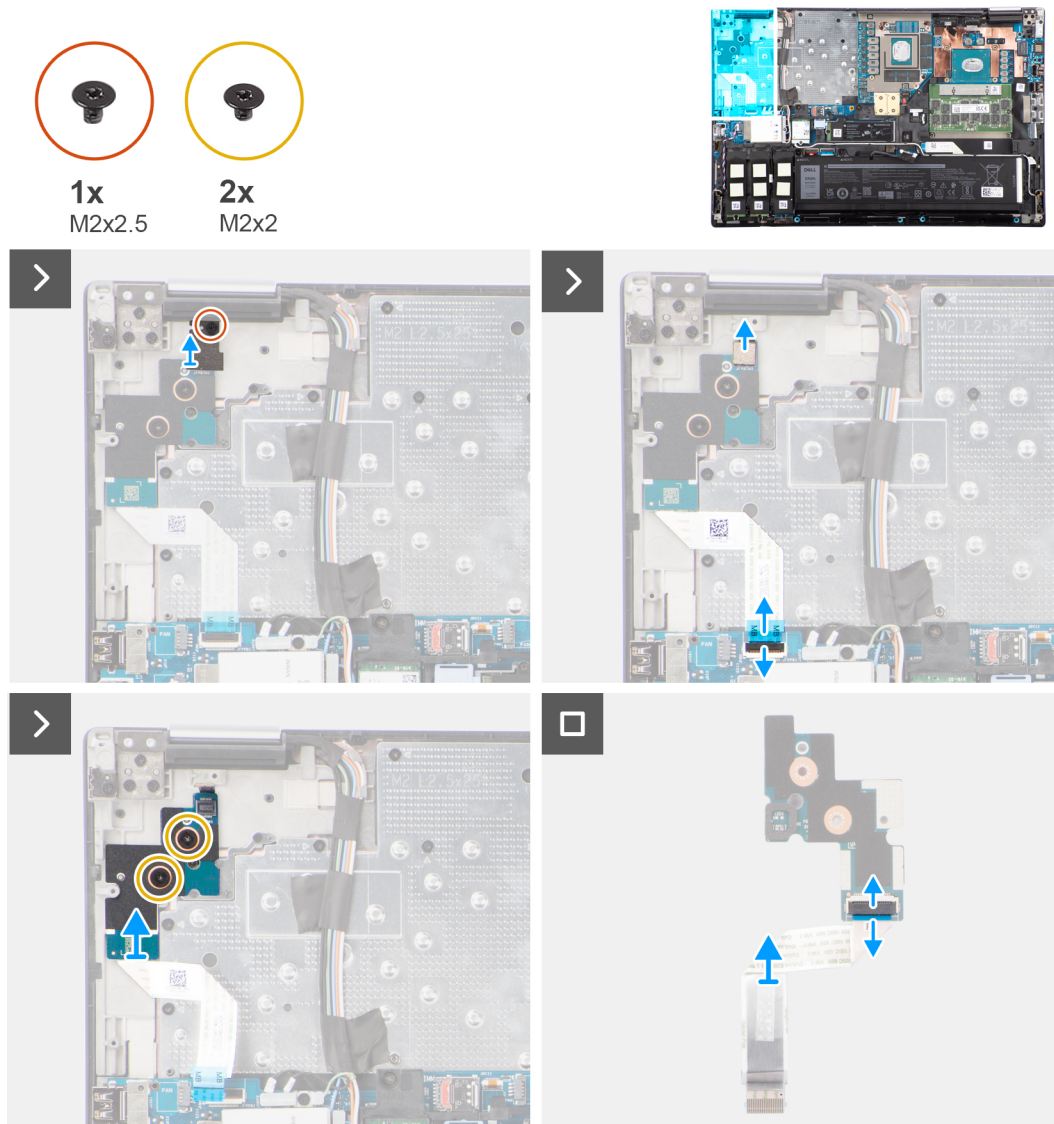

Steps

1. Remove the (M2x3) screw that secures the power button board to the computer.
2. Remove the two (M2x2) screws that secure the power button board to the computer.
3. Remove the power button board with the power button board FFC from the computer.
4. Disconnect the power button board FFC from the power button board.

Installing the power button board

Prerequisites

If you are replacing a component, remove the existing component before performing the installation procedure.

About this task

The figure indicates the location of the power button board and provides a visual representation of the installation procedure.

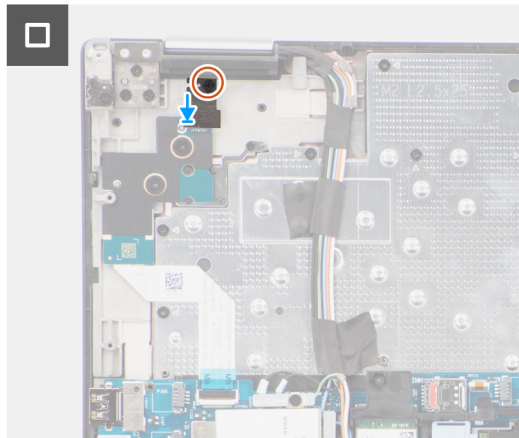
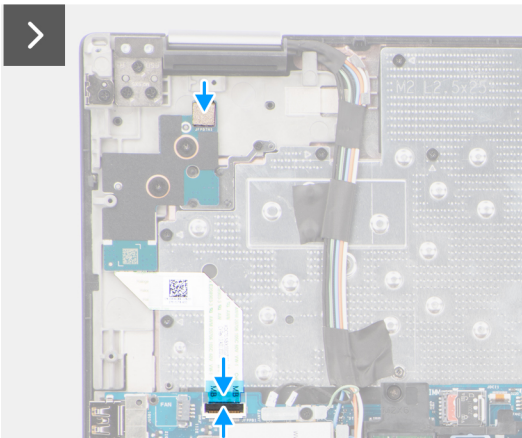
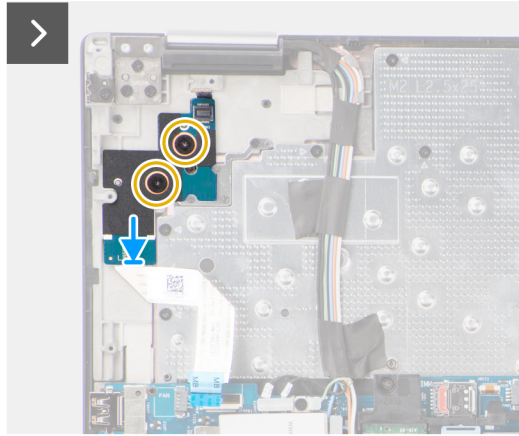
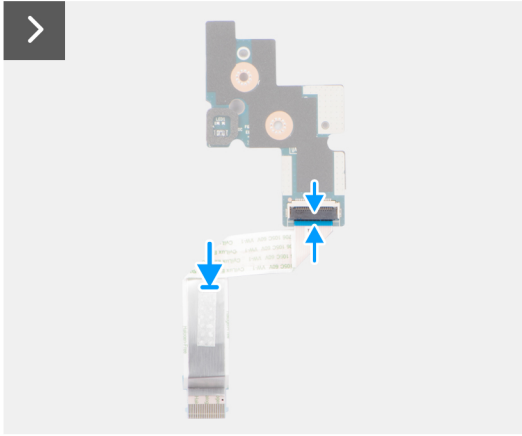
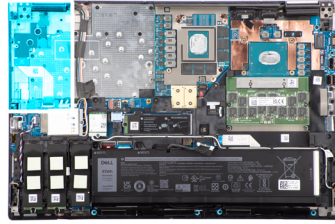

Steps

1. Connect the power button board FFC to the power button board.
2. Align and place the power button board with the power button FFC into its slot on the computer.
3. Replace the two (M2x2) screws to secure the power button board to the computer.
4. Replace the (M2x3) screw to secure the power button board to the computer.
5. Connect the power button board FFC to the connector on the system board.

Next steps

1. Install the [heat-sink for discrete graphics](#).
2. Install the [base cover](#).
3. Follow the procedure in [after working inside your computer](#).

Power button

Removing the power button

Prerequisites

1. Follow the procedure in [before working inside your computer](#).
2. Remove the [base cover](#).
3. Remove the [heat-sink for discrete graphics](#).
4. Remove the [power button board](#).

About this task

The figure indicates the location of the power button and provides a visual representation of the removal procedure.

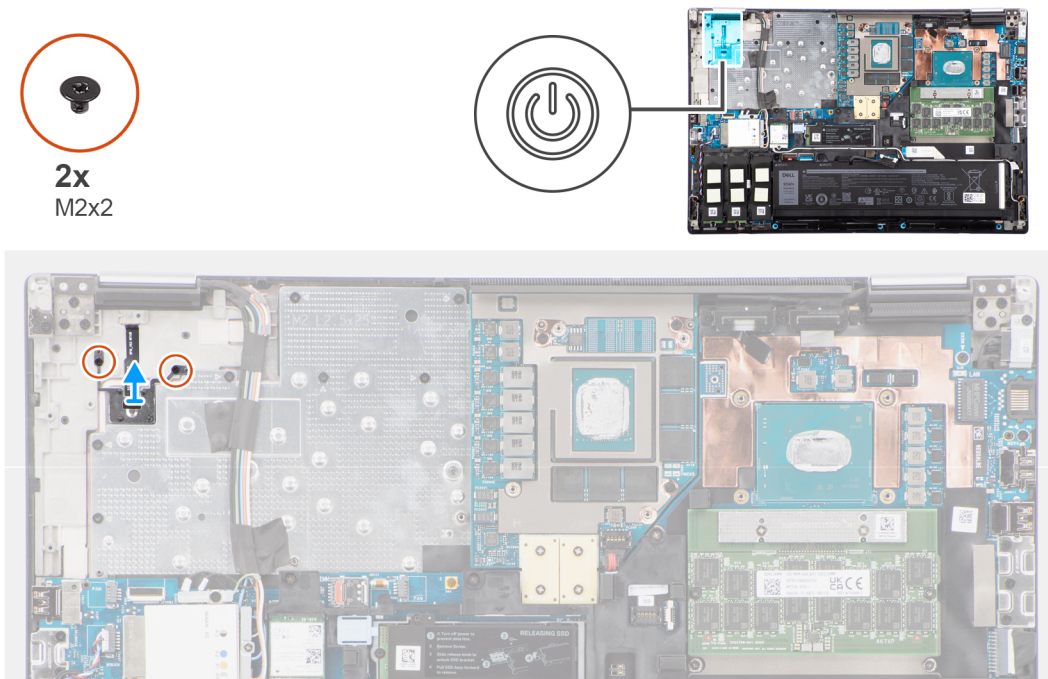

Steps

1. Remove the two (M2x2) screws that secure the power button in its slot on the computer.
2. Lift to remove the power button from the computer.

Installing the power button

Prerequisites

If you are replacing a component, remove the existing component before performing the installation procedure.

About this task

The figure indicates the location of the power button and provides a visual representation of the installation procedure.



2x
M2x2

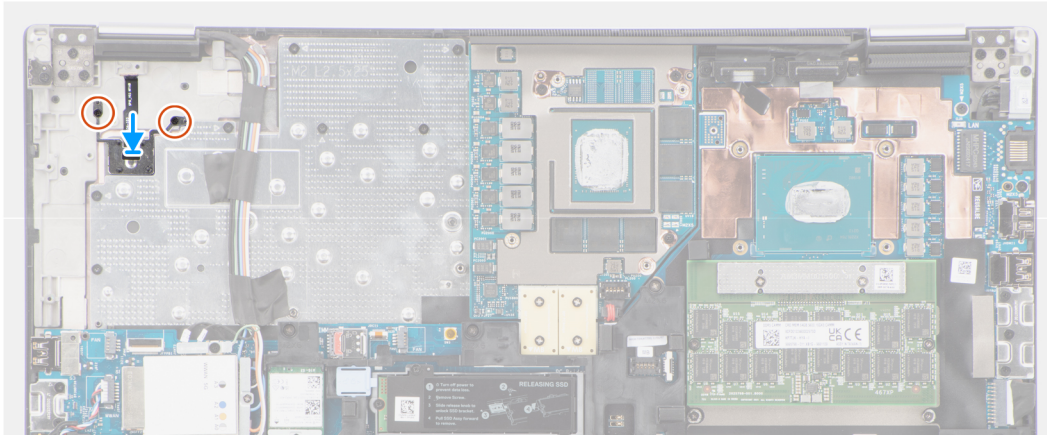
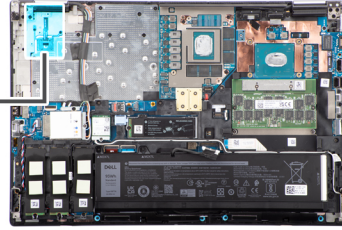

Steps

1. Align and place the power button into its slot on the computer.
2. Replace the two (M2x2) screws to secure the power button in place.

Next steps

1. Install the [power button board](#).
2. Install the [heat-sink for discrete graphics](#).
3. Install the [base cover](#).
4. Follow the procedure in [after working inside your computer](#).

Speakers

Removing the speakers

Prerequisites

1. Follow the procedure in [before working inside your computer](#).
2. Remove the [base cover](#).
3. Remove the [primary solid-state drive](#).
4. Remove the [secondary solid-state drive](#).
5. Remove the [battery](#).

About this task

The figure indicates the location of the speakers and provides a visual representation of the removal procedure.



1x
M2x2

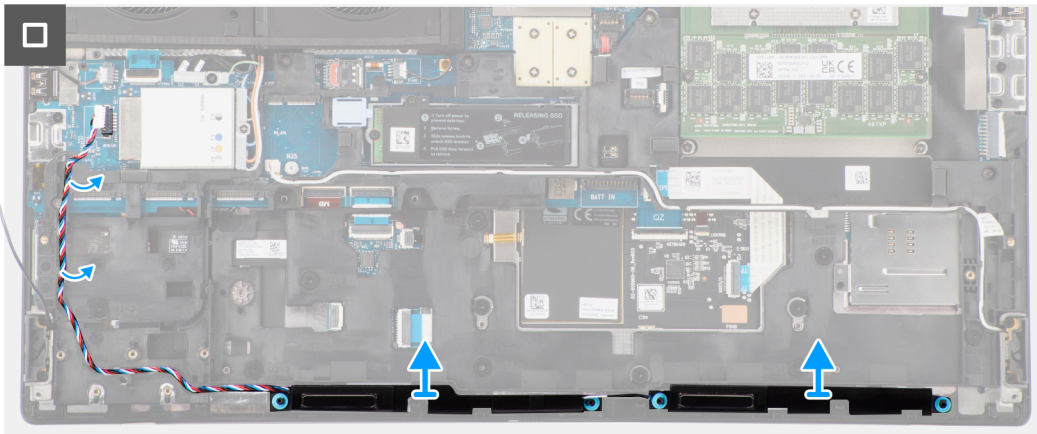
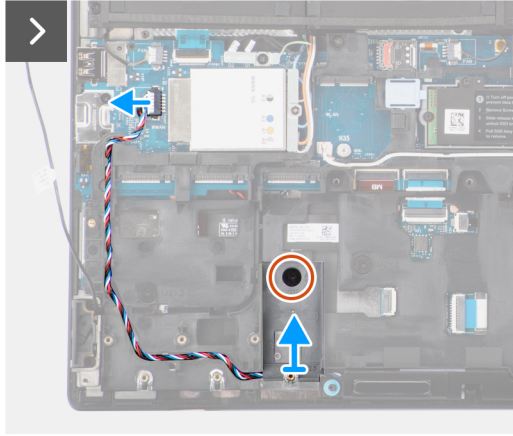
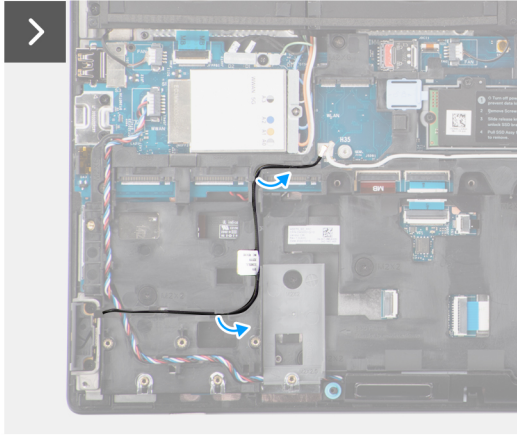
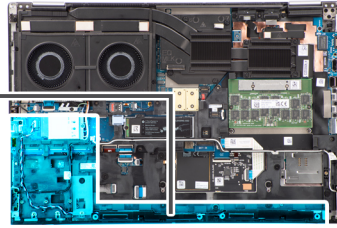
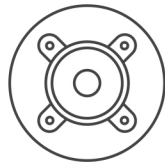

Steps

1. Disconnect the speaker cable from the system board.
2. Only for 93 Whr battery: Remove the (M2x2) screw that secures the SSD frame in the slot-2 SSD in place.
3. Unroute the speaker cable from the routing threads on the inner frame.
4. Pry the speaker module from its slot on the top edge of the palm rest.
5. Remove the speaker module from the system chassis.

Installing the speakers

Prerequisites

If you are replacing a component, remove the existing component before performing the installation procedure.

About this task

The figure indicates the location of the speakers and provides a visual representation of the installation procedure.



1x
M2x2

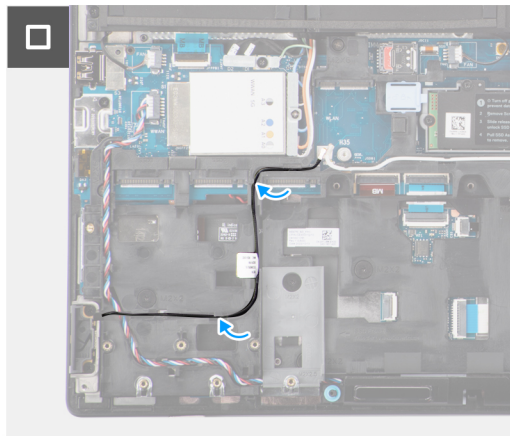
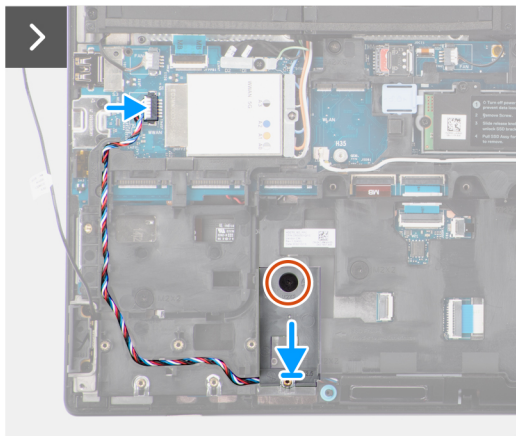
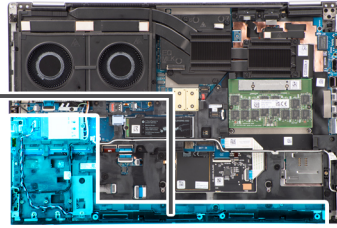
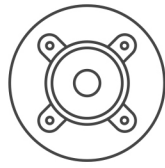

Steps

1. Align and place the speaker module into its slot on the top edge of the palm rest.
2. Route the speaker cable using the routing threads on the inner frame.
3. Only for 93 Whr battery: Replace the (M2x2) screw that secures the SSD frame in the slot-2 SSD in place.
4. Connect the speaker cable to its connector on the system board.

Next steps

1. Install the [battery](#).
2. Install the [secondary solid-state drive](#).
3. Install the [primary solid-state drive](#).
4. Install the [base cover](#).
5. Follow the procedure in [after working inside your computer](#).

Inner frame

Removing the inner frame

Prerequisites

1. Follow the procedure in [before working inside your computer](#).
2. Remove the [base cover](#).
3. Remove the [primary solid-state drive](#).
4. Remove the [secondary solid-state drive](#).
5. Remove the [battery](#).

About this task

The figure indicates the location of the inner frame and provides a visual representation of the removal procedure.



9x
M2x2



5x
M2x5

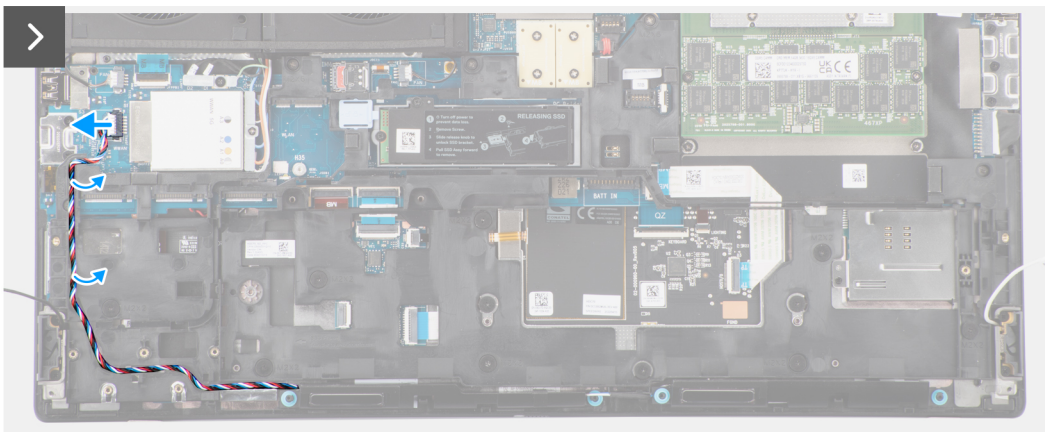
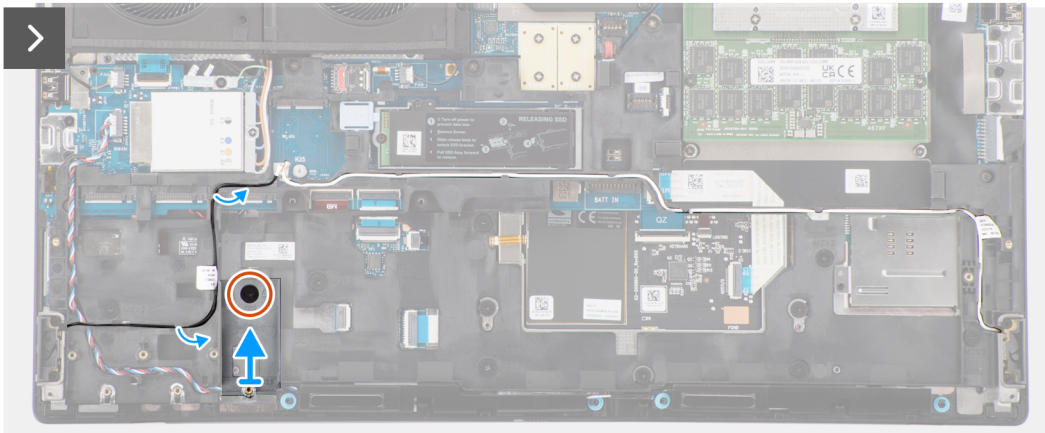
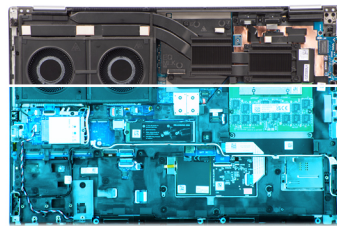

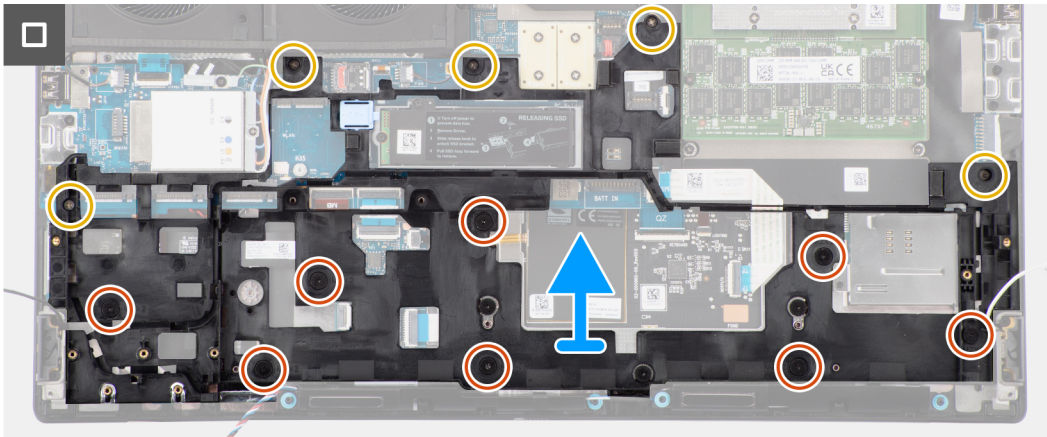

Steps

1. Remove the (M2x2) screw that secures the SSD frame in the slot-2 SSD in place.
2. Disconnect the two WLAN antennas and speaker cable from their connectors on the system board.
3. Unroute the WLAN antennas and speaker cable from the routing guide on the inner frame.
4. Remove the five (M2x5) and the eight (M2x2) screws that secure the inner frame to the computer chassis.
5. Remove the inner frame from the computer.

Installing the inner frame

Prerequisites

If you are replacing a component, remove the existing component before performing the installation procedure.

About this task

The figure indicates the location of the inner frame and provides a visual representation of the installation procedure.

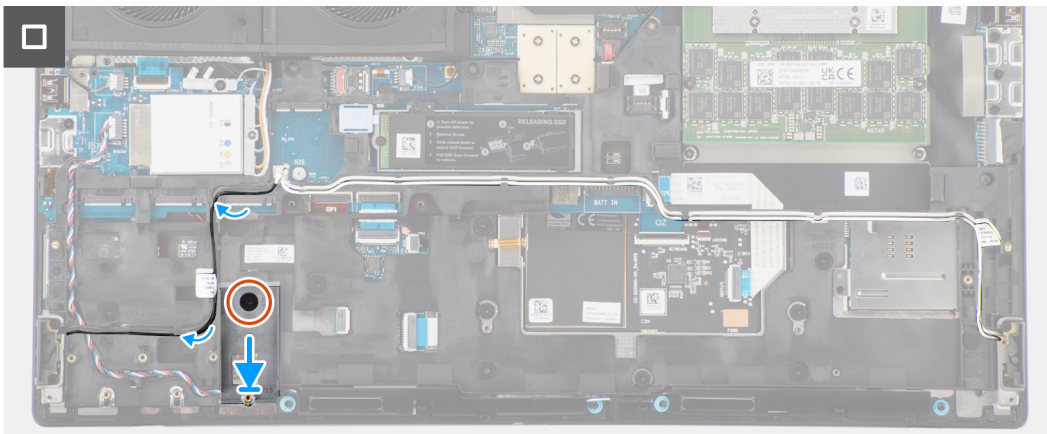
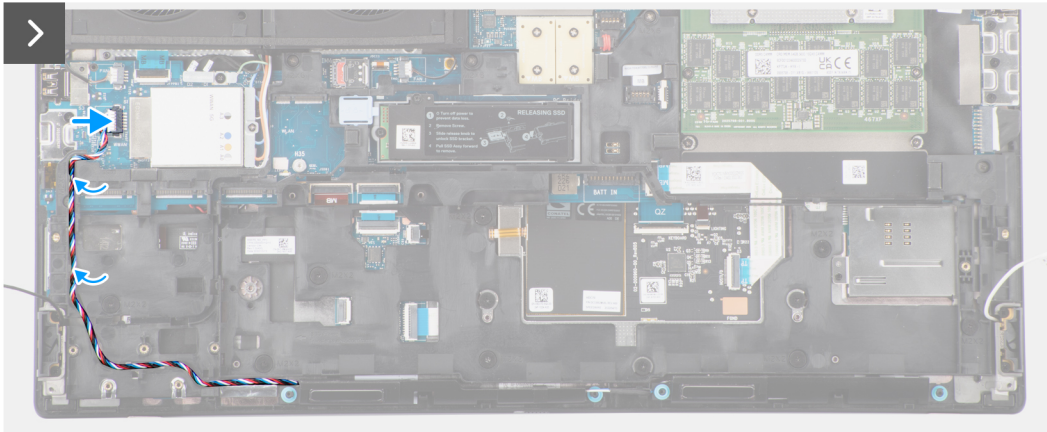
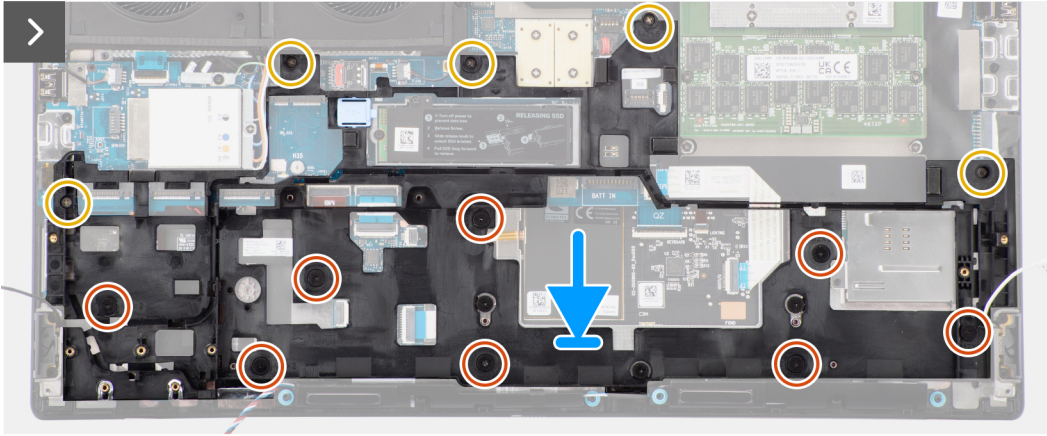
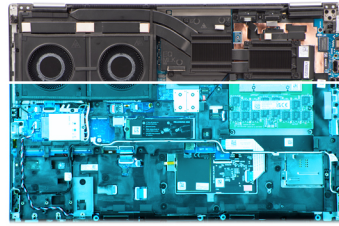

Steps

1. Align and place the inner frame in the computer chassis.
2. Replace the five (M2x5) and the eight (M2x2) screws that secure the inner frame to the computer chassis.
3. Route the WLAN antennas and speaker cable using the routing guide on the inner frame.
4. Replace the (M2x2) screw that secures the SSD frame in the slot-2 SSD in place.

Next steps

1. Install the [battery](#).
2. Install the [secondary solid-state drive](#).
3. Install the [primary solid-state drive](#).
4. Install the [base cover](#).
5. Follow the procedure in [after working inside your computer](#).

SD card reader

Removing SD card reader

Prerequisites

1. Follow the procedure in [before working inside your computer](#).
2. Remove the [base cover](#).
3. Remove the [primary solid-state drive](#).
4. Remove the [secondary solid-state drive](#).
5. Remove the [battery](#).
6. Remove the [inner frame](#).

About this task

The figure indicates the location of the SD card reader and provides a visual representation of the removal procedure.



1x
M2x2

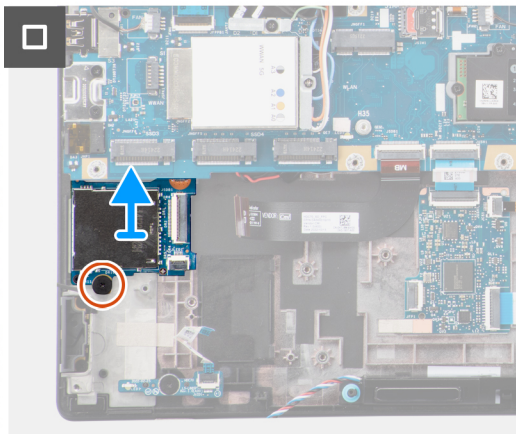
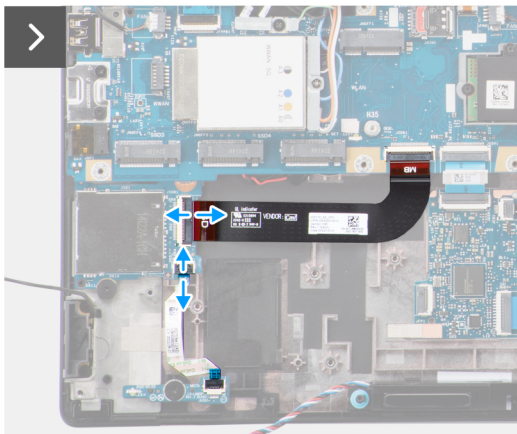
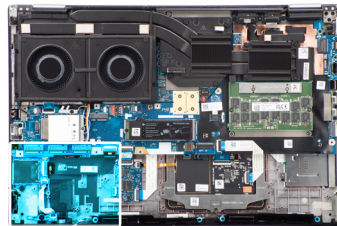

Steps

1. Disconnect the SD card reader flat printed cable (FPC) and LED board FFC from their connector on the SD card reader.
2. Remove the (M2x2) screw that secures the SD card reader on the computer chassis.
3. Lift to remove the SD card reader with its FPC out of the computer.

Installing SD card reader

Prerequisites

If you are replacing a component, remove the existing component before performing the installation procedure.

About this task

The figure indicates the location of the SD card reader and provides a visual representation of the installation procedure.

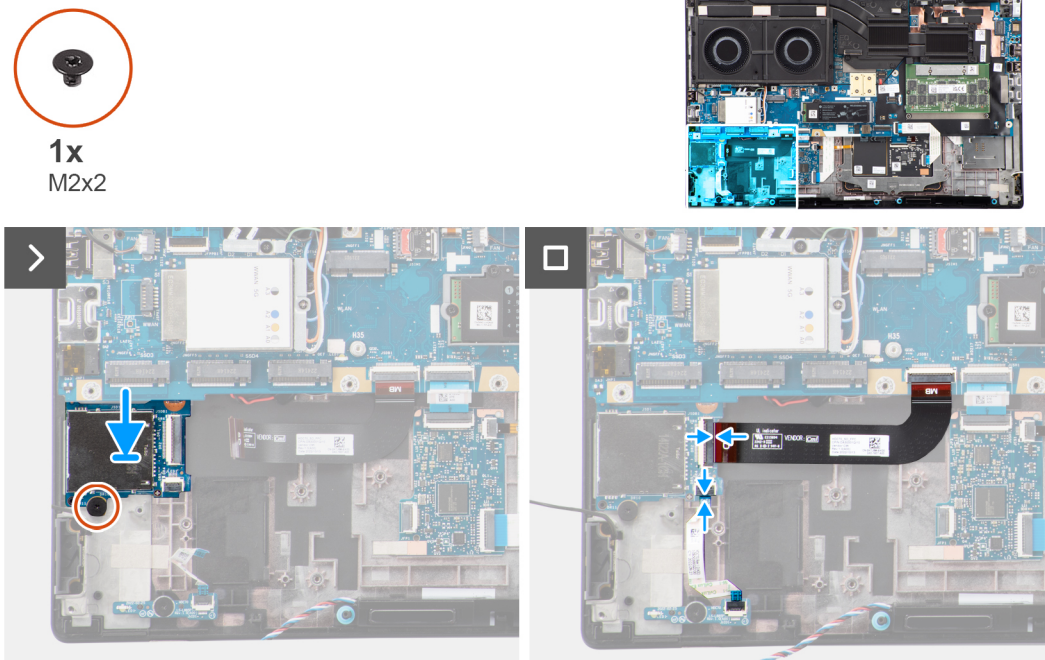

Steps

1. Align and place the SD card reader with the FPC into its slot on the computer chassis.
2. Replace the (M2x2) screw to secure the SD card reader to the computer chassis.
3. Connect the LED board FFC and SD card reader FPC to the SD card reader.

Next steps

1. Install the [inner frame](#).
2. Install the [battery](#).
3. Install the [secondary solid-state drive](#).
4. Install the [primary solid-state drive](#).
5. Install the [base cover](#).
6. Follow the procedure in [after working inside your computer](#).

SD card reader FPC

Removing SD card reader FPC

Prerequisites

1. Follow the procedure in [before working inside your computer](#).
2. Remove the [base cover](#).
3. Remove the [primary solid-state drive](#).

4. Remove the [secondary solid-state drive](#).
5. Remove the [battery](#).
6. Remove the [inner frame](#).

About this task

The figure indicates the location of the SD card reader FPC and provides a visual representation of the removal procedure.

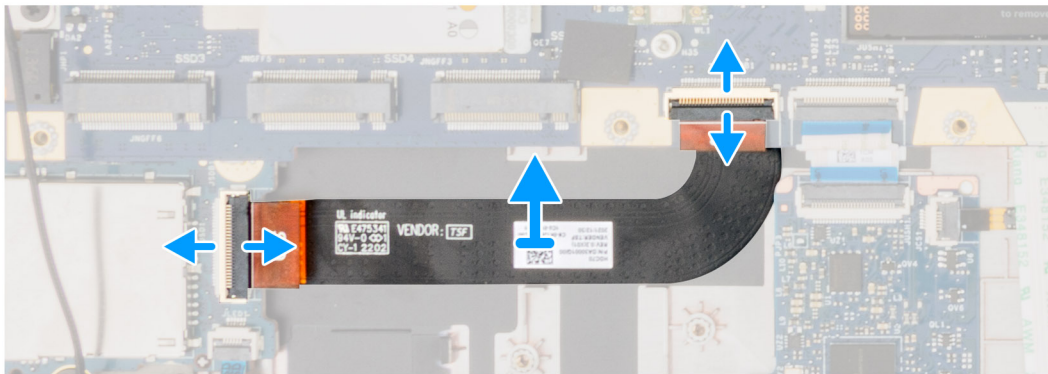
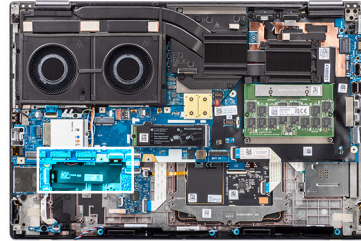

Steps

1. Disconnect the SD card reader FPC from its connector on the SD card reader and system board.
2. Peel to remove the SD card reader FPC from the computer chassis.

Installing SD card reader FPC

Prerequisites

If you are replacing a component, remove the existing component before performing the installation procedure.

About this task

The figure indicates the location of the SD card reader FPC and provides a visual representation of the installation procedure.

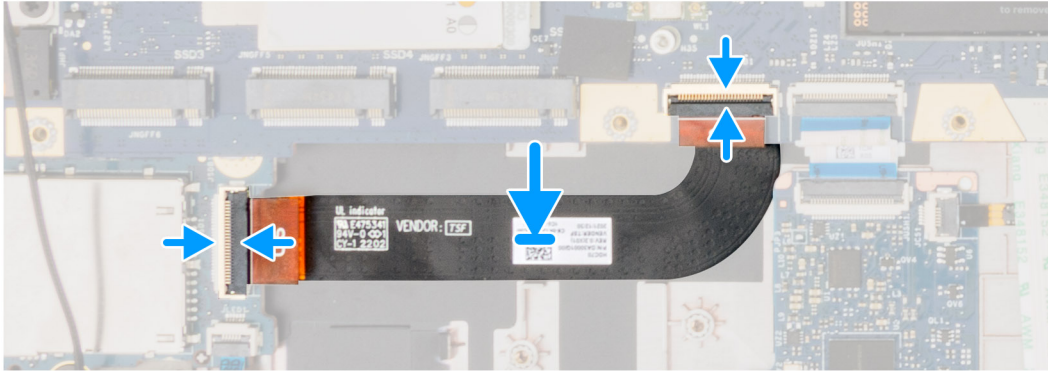
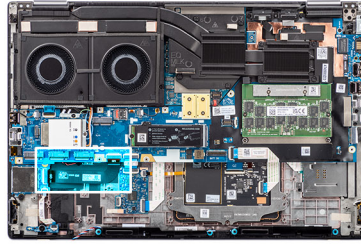

Steps

1. Adhere the SD card reader FPC into its slot on the computer chassis.
2. Connect the SD card reader FPC to its connectors on the SD card reader and system board.

Next steps

1. Install the [inner frame](#).
2. Install the [battery](#).
3. Install the [secondary solid-state drive](#).
4. Install the [primary solid-state drive](#).
5. Install the [base cover](#).
6. Follow the procedure in [after working inside your computer](#).

System board

Removing the system board

Prerequisites

1. Follow the procedure in [before working inside your computer](#).
2. Remove the [base cover](#).
3. Remove the [SIM card](#).
4. Remove the [battery](#).
5. Remove the [CAMM module](#) or [memory module](#).
6. Remove the [interposer board module](#).
7. Remove the [WLAN card](#).
8. Remove the [WWAN card](#).
9. Remove the [primary solid-state drive](#).
10. Remove the [secondary solid-state drive](#).
11. Remove the [heat-sink for discrete graphics](#).
12. Remove the [inner frame](#).

About this task

The figure indicates the location of the system board and provides a visual representation of the removal procedure.

The following image indicates the connectors on your system board:

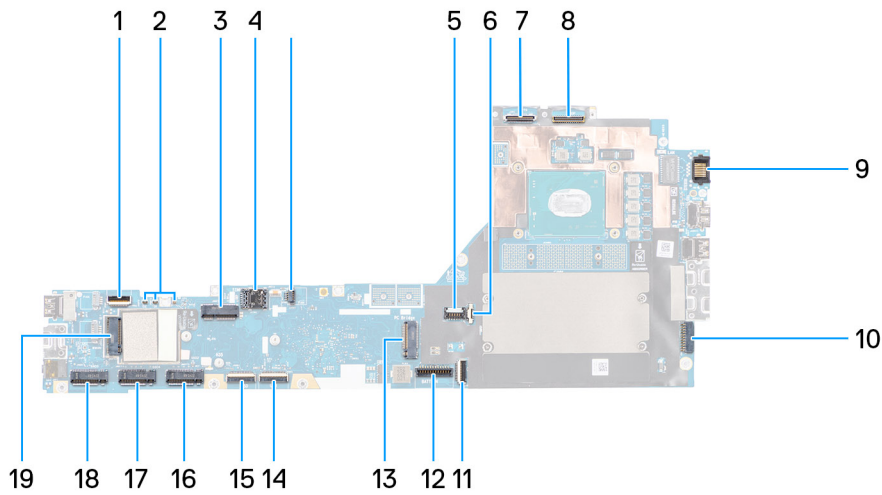

1. Fan cable connector
2. Power button FFC connector
3. WLAN card connector
4. SIM card slot
5. WWAN (Darwin) antenna connectors
6. SIM card slot
7. Fan cable connector
8. GPU power cable connector
9. IR camera cable connector
10. Display cable connector
11. LAN port
12. Power adapter cable connector
13. Touchpad cable connector
14. Battery cable connector
15. M.2 SSD slot 5 connector
16. USH board cable connector
17. SD card reader FPC cable connector
18. WLAN antenna cable connectors
19. M.2 SSD slot 2 connector
20. M.2 SSD slot 3 connector
21. WWAN card connector
22. M.2 SSD slot 4 connector
23. Speaker cable connector



4x
M2x6



11x
M2x5



4x
M2x3.5

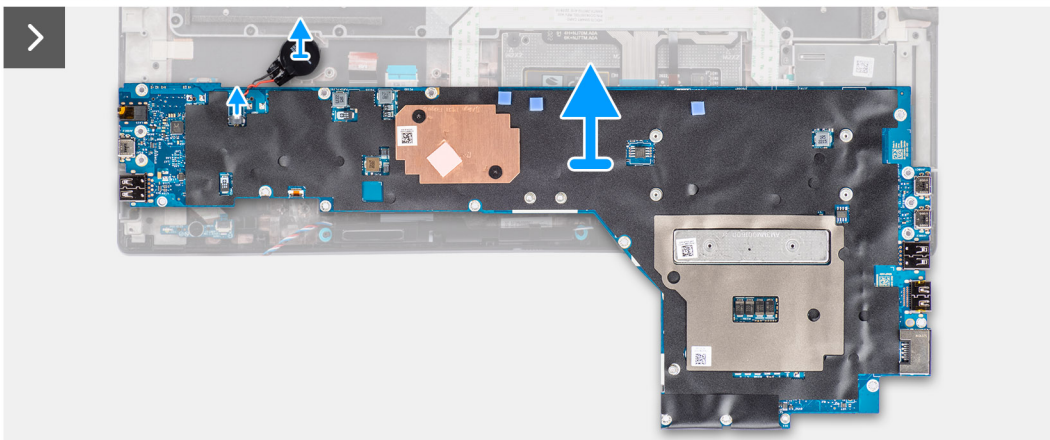
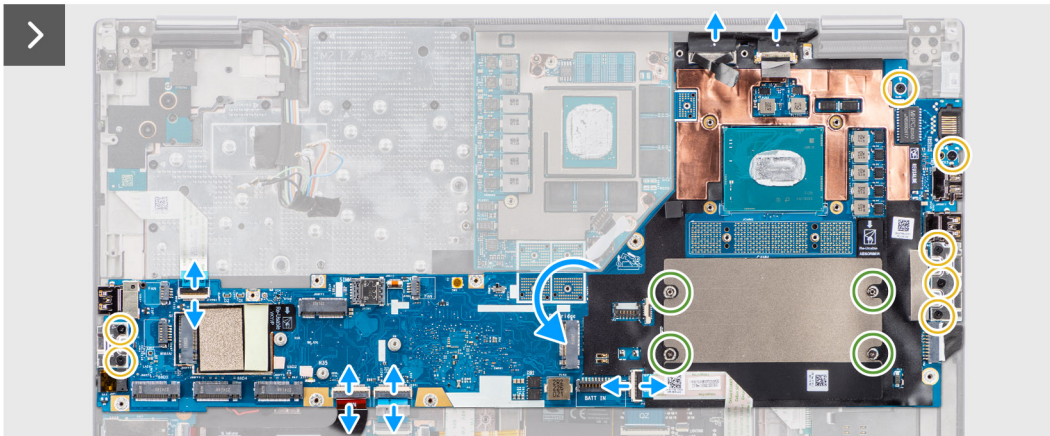
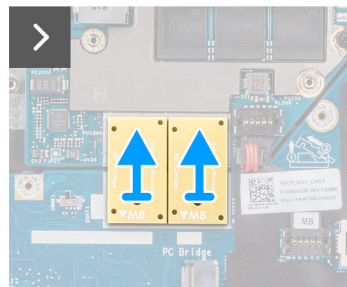
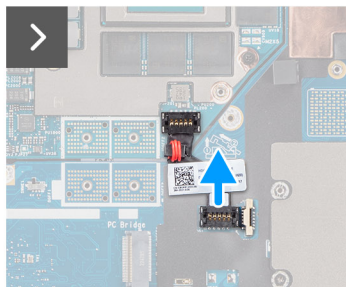
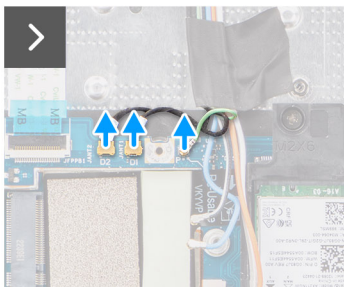
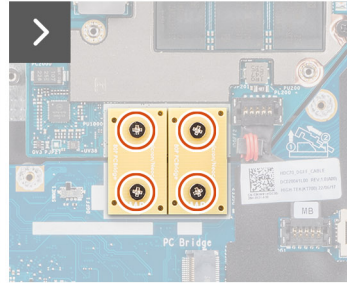
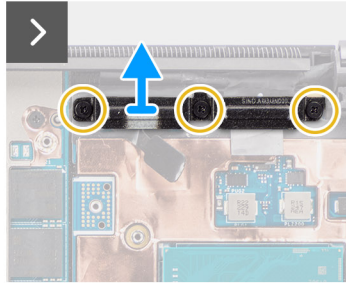
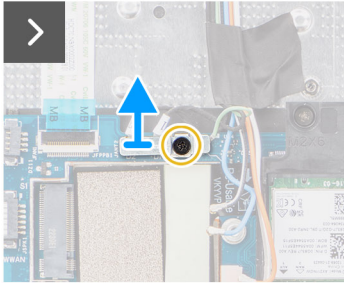
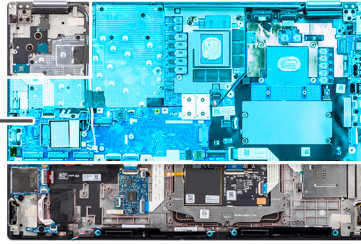

Steps

1. Remove the (M2x5) screw that secures the WLAN bracket to the system board.
2. Lift to remove the WLAN bracket.
3. Disconnect the antennas from their connectors.
4. Carefully pry the outside end of the GPU power cable connector head to unlock the GPU power cable connector from the system board on top side of the system.
5. Slightly slide the GPU power cable connector outwards to disconnect the GPU power cable from the connector on the system board.
6. Remove the four (M2x6) screws that secure the two PCB beam connectors to the system board and the GPU card.
 - NOTE:** For models shipped with an integrated GPU card, the PCB beam connectors are on the bottom and top-right side of the GPU card. For models shipped with a discrete GPU card, the PCB beam connectors are at the bottom side of the GPU card.
7. Remove the PCB beam connectors from the computer.
8. Remove the three (M2x5) screws that secure the display cable bracket in place.
9. Remove the display cable bracket from the computer.
10. Disconnect the touch screen cable (for models shipped with a touch screen) or IR camera cable (for models that are shipped with an IR camera) and display cable from their connectors on the system board.
11. Disconnect the power button board FFC from the system board, touchpad FFC, USH daughter board FFC (for models shipped with a USH daughter board), and SD card reader FPC cables.
12. Remove the seven (M2x5) screws that secure the system board to the computer chassis.
13. Remove the four stand-off nuts (M2x3.5) that secure the CAMM memory.
 - NOTE:** This step is only applicable for configurations with CAMM memory.
 - NOTE:** In case of system board replacement, these four stand-off nuts need to be transferred from the old system board to the new system board.
14. Flip the system board and disconnect the coin-cell battery cable from its connector on the system board.
15. Remove the system board from the computer.

After removing the system board from the system, the following items **MUST** be transferred to the replacement system board:

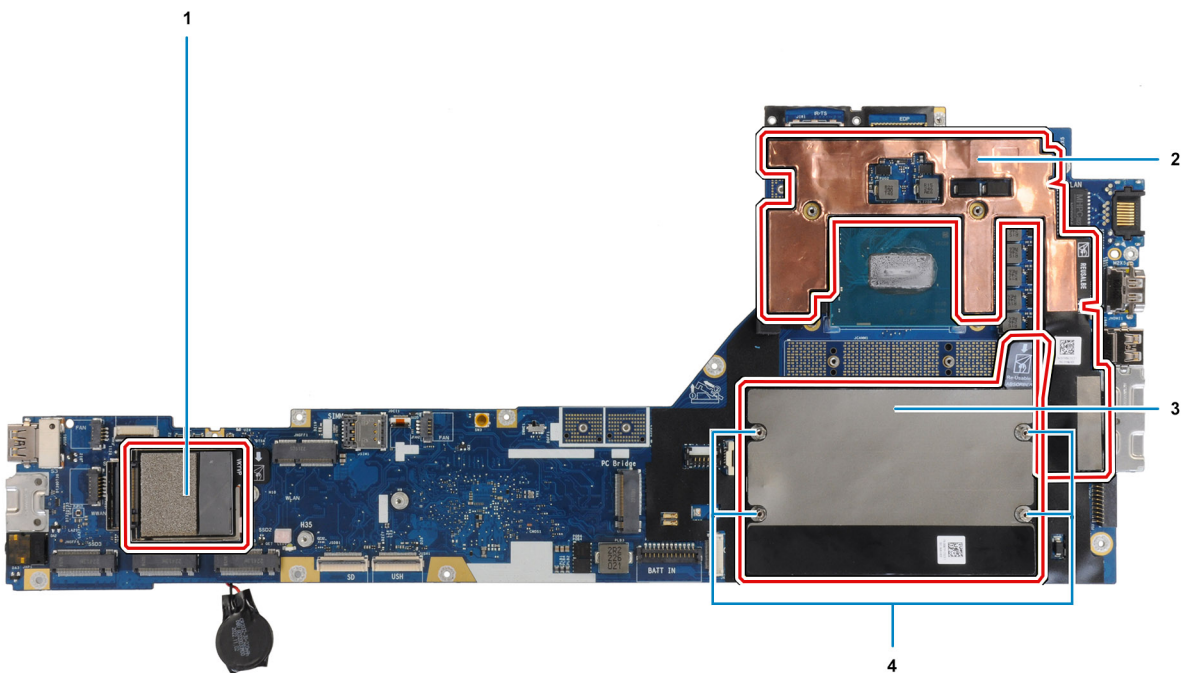

Table 4. System board replacement components

SI. No	Item
1	WWAN card thermal pad (for models shipped with WWAN antennas)
2	CPU graphite absorber sticker (for models shipped with WWAN antennas)
3	CAMM memory absorber (for models shipped with a CAMM module)
4	Hexagonal standoff nuts x4 (for models shipped with a CAMM module)

NOTE:

- The hexagonal standoff nuts can be removed with a flat-head screwdriver.
- There are no absorbers or standoff nuts to be transferred for models that are shipped with a DIMM memory module and without WWAN antennas.

Installing the system board

Prerequisites

If you are replacing a component, remove the existing component before performing the installation procedure.

About this task

The figure indicates the location of the system board and provides a visual representation of the installation procedure.



4x
M2x6



11x
M2x5



4x
M2x3.5

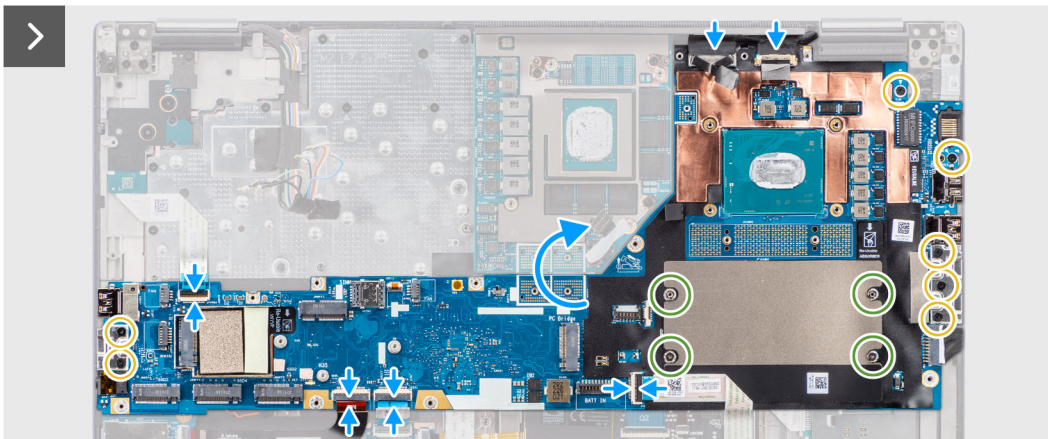
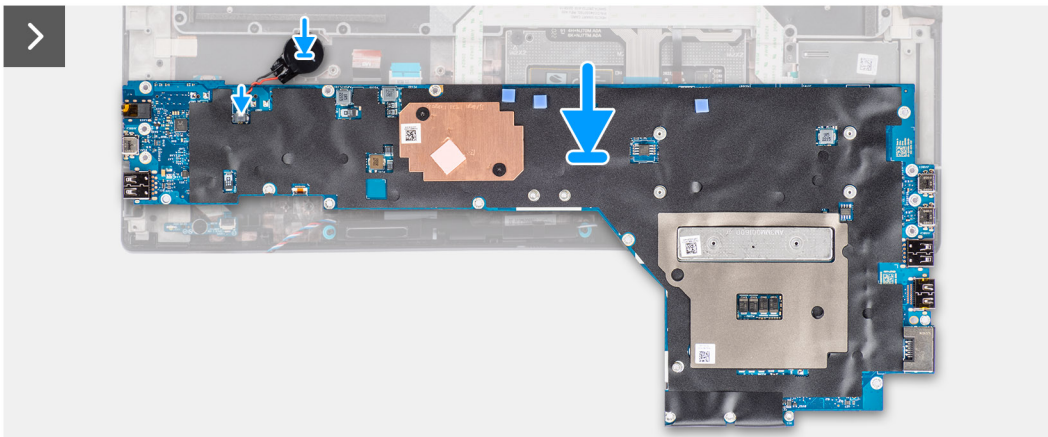
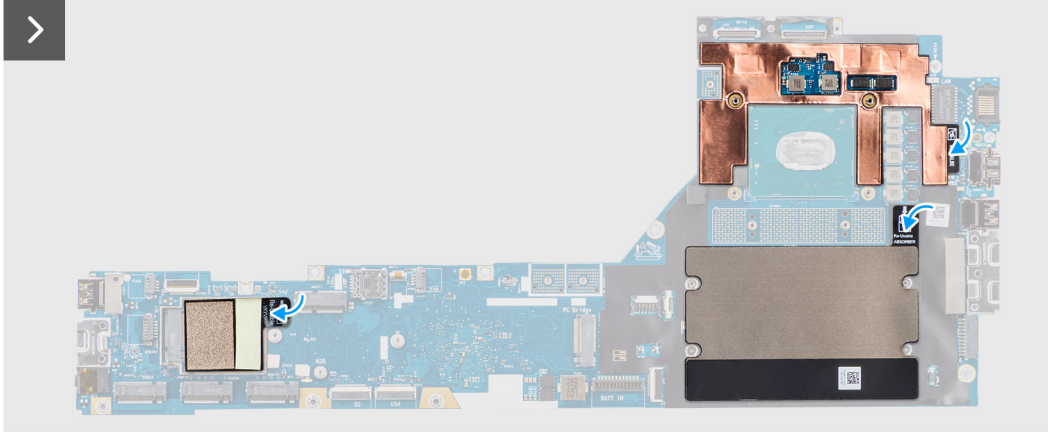
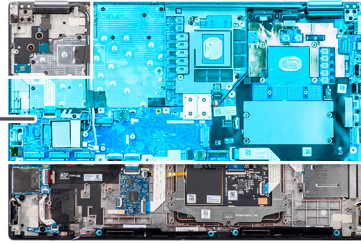

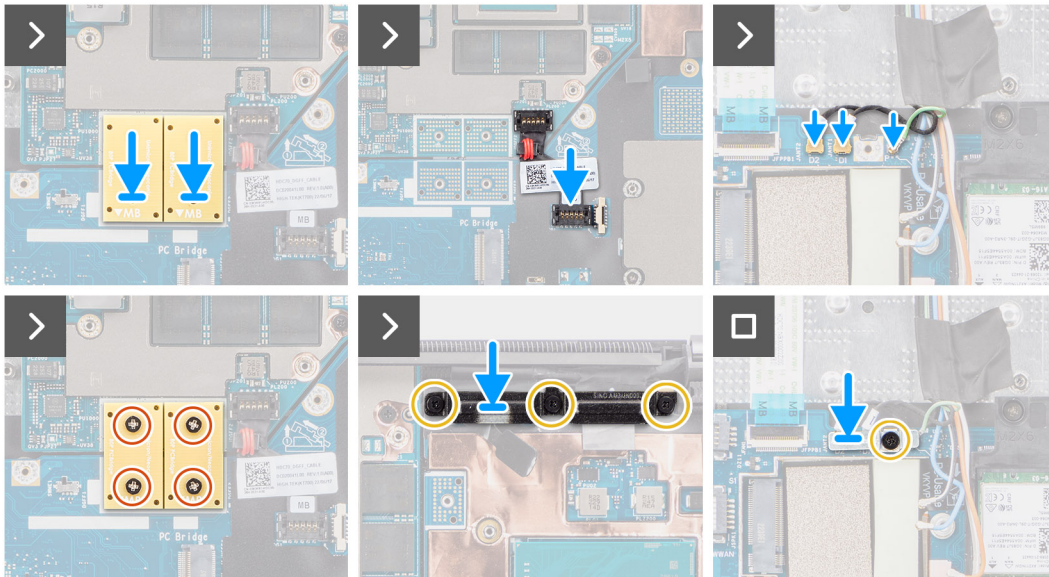

Steps

1. Connect the coin-cell battery cable to its connector on the system board and flip the system board.
2. Replace the four stand-off nuts (M2x3.5) to secure the CAMM memory.
 - i** **NOTE:** This step is only applicable for configurations with CAMM memory.
 - i** **NOTE:** In case of system board replacement, these four stand-off nuts need to be transferred from the old system board to the new system board.
3. Replace the seven (M2x5) screws to secure the system board to the computer chassis.
4. Replace the display cable bracket on the display cable.
5. Replace the (M2x5) screw to secure the display cable bracket to the system board.
6. Connect the power button board FFC from the system board, touchpad FFC, USH daughter board FFC (for models shipped with a USH daughter board), and SD card reader FPC cables.
7. Connect the touch screen cable (for models shipped with a touch screen) or IR camera cable (for models that are shipped with an IR camera) and display cable to their connectors on the system board.
8. Replace the three (M2x5) screws to secure the display cable bracket in place.
9. Align the screw holes, and replace the four (M2x6) screws to secure the two PCB beam connectors to the system board and the GPU card.
 - i** **NOTE:** For models shipped with an integrated GPU card, the PCB beam connectors are on the bottom and top-right side of the GPU card. For models shipped with a discrete GPU card, the PCB beam connectors are at the bottom side of the GPU card.
10. Connect the GPU power cable to the connector on the system board on the top side of the computer.
11. Lock the GPU power cable connector on the system board.
12. Connect the antennas to their connectors.
13. Replace the (M2x5) screw to secure the WLAN bracket to the system board.

Next steps

1. Install the [inner frame](#).
2. Install the [heat-sink for discrete graphics](#).
3. Install the [secondary solid-state drive](#).
4. Install the [primary solid-state drive](#).
5. Install the [WWAN card](#).
6. Install the [WLAN card](#).
7. Install the [interposer board module](#).
8. Install the [CAMM module](#) or [memory module](#).

9. Install the [battery](#).
10. Install the [SIM card](#).
11. Install the [base cover](#).
12. Follow the procedure in [after working inside your computer](#).

Coin-cell battery

Removing the coin-cell battery

Prerequisites

1. Follow the procedure in [before working inside your computer](#).
2. Remove the [base cover](#).
3. Remove the [SIM card](#).
4. Remove the [battery](#).
5. Remove the [CAMM module](#) or [memory module](#).
6. Remove the [interposer board module](#).
7. Remove the [WWAN card](#).
8. Remove the [primary solid-state drive](#).
9. Remove the [secondary solid-state drive](#).
10. Remove the [heat-sink for discrete graphics](#).
11. Remove the [inner frame](#).
12. Remove the [system board](#).

About this task

The figure indicates the location of the coin-cell battery and provides a visual representation of the removal procedure.

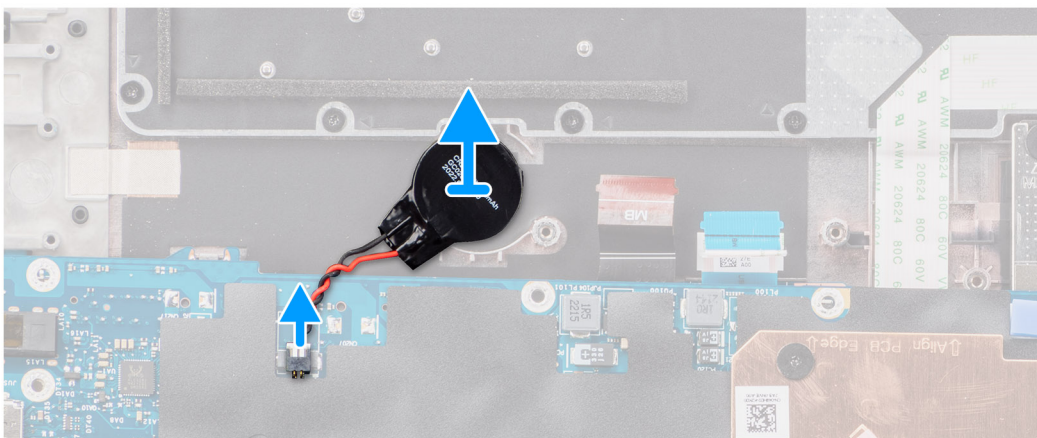
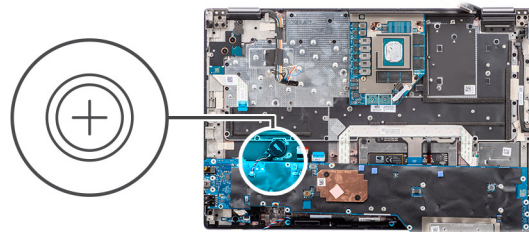

Steps

Pry to remove the coin-cell battery, which is located under the system board, from the palmrest while lifting the system board.

Installing the coin-cell battery

Prerequisites

If you are replacing a component, remove the existing component before performing the installation procedure.

About this task

The figure indicates the location of the coin-cell battery and provides a visual representation of the installation procedure.

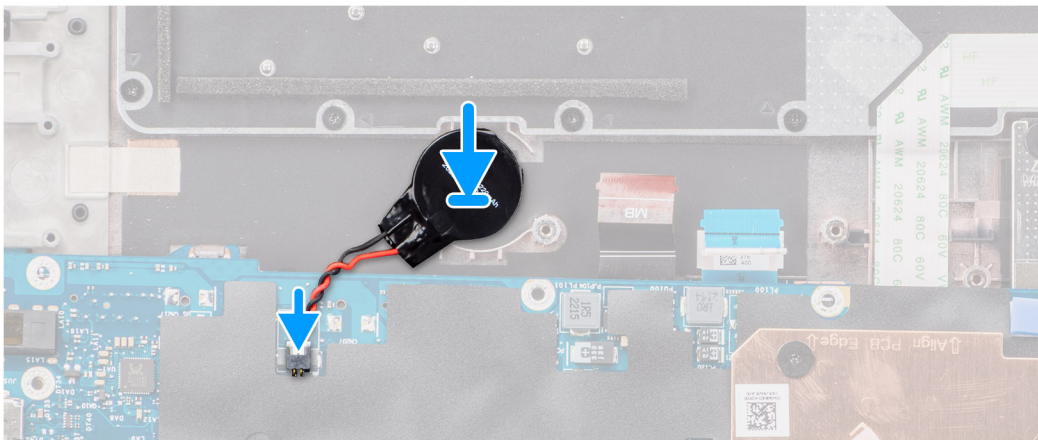
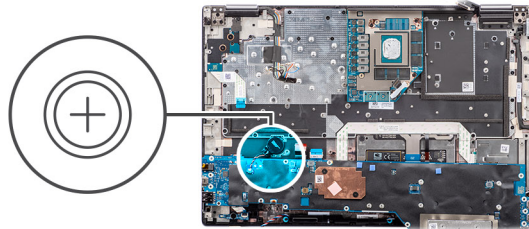

Steps

Adhere the coin-cell battery to the palmrest.

Next steps

1. Install the [system board](#).
2. Install the [inner frame](#).
3. Install the [heat-sink for discrete graphics](#).
4. Install the [secondary solid-state drive](#).
5. Install the [primary solid-state drive](#).
6. Install the [WWAN card](#).
7. Install the [interposer board module](#).
8. Install the [CAMM module](#) or [memory module](#).
9. Install the [battery](#).
10. Install the [SIM card](#).
11. Install the [base cover](#).
12. Follow the procedure in [after working inside your computer](#).

Display assembly

Removing the display assembly

Prerequisites

1. Follow the procedure in [before working inside your computer](#).
2. Remove the [base cover](#).
3. Remove the [SIM card](#).
4. Remove the [battery](#).
5. Remove the [CAMM module](#) or [memory module](#).
6. Remove the [interposer board module](#).
7. Remove the [WWAN card](#).
8. Remove the [primary solid-state drive](#).
9. Remove the [secondary solid-state drive](#).
10. Remove the [heat-sink for discrete graphics](#).
11. Remove the [inner frame](#).

About this task

The figure indicates the location of the display assembly and provides a visual representation of the removal procedure.



4x
M2x5



6x
M2.5x5

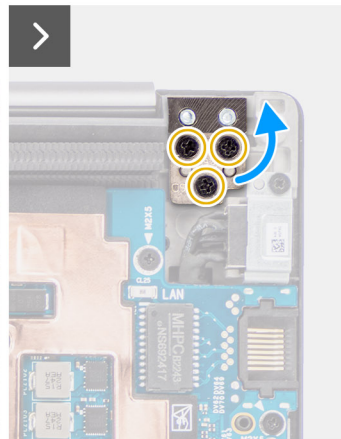
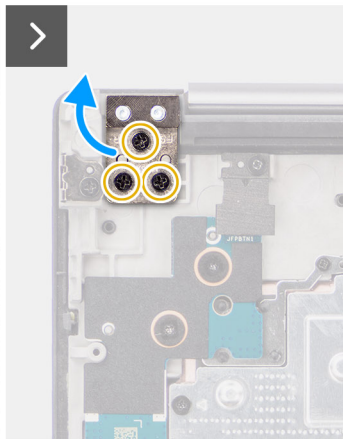
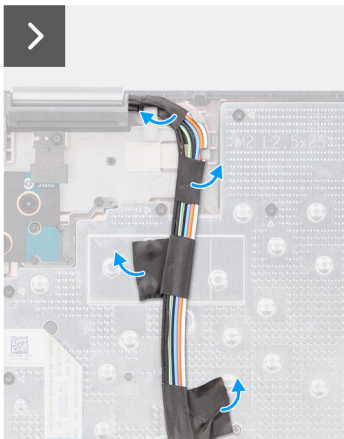
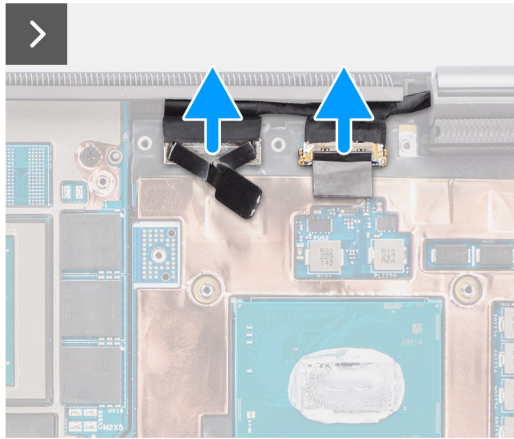
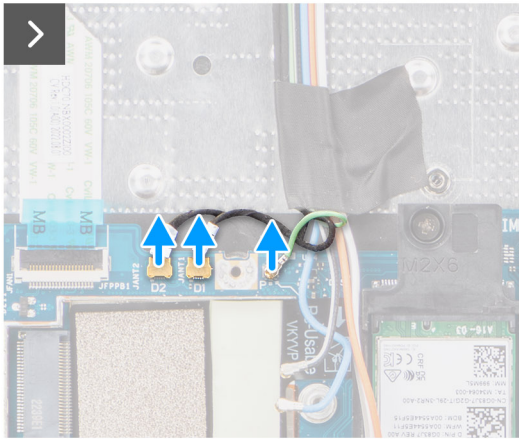
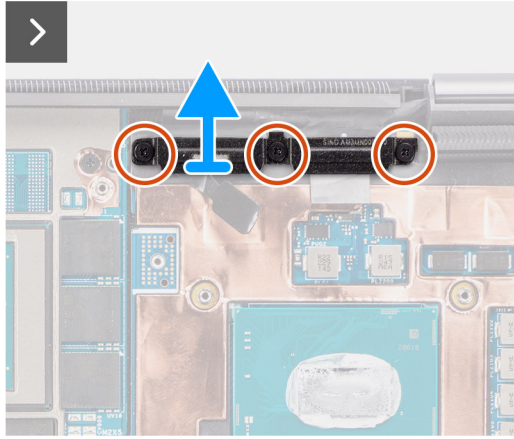
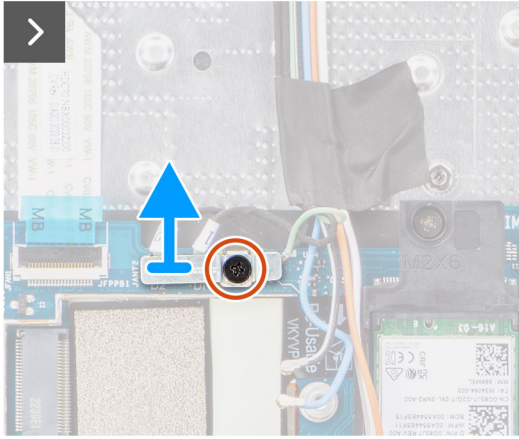
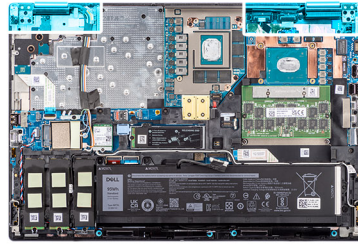

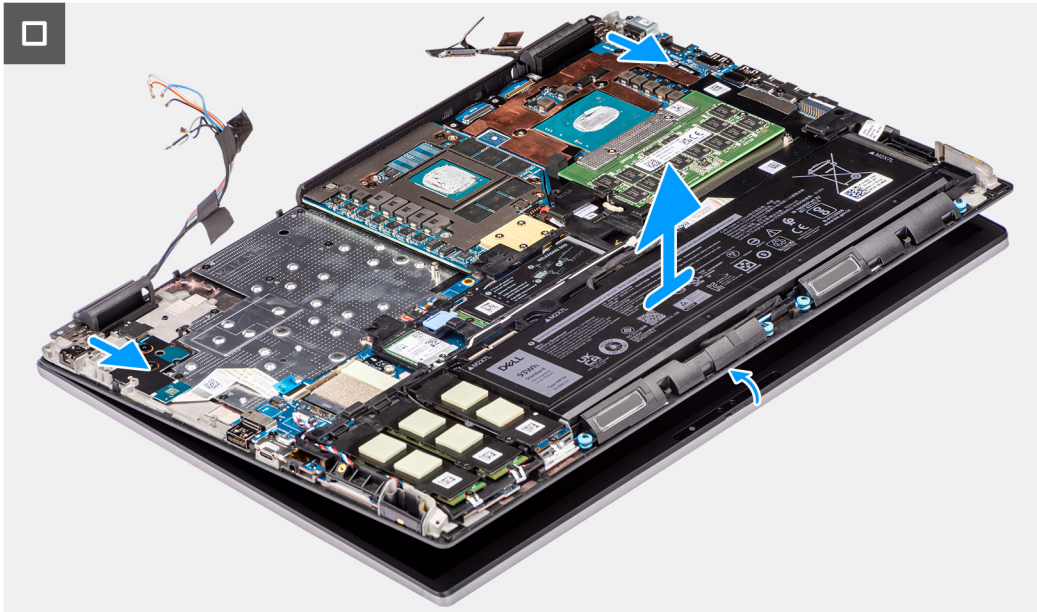

Steps

1. Remove the (M2x5) screw that secures the WLAN bracket to the system board.
2. Lift to remove the WLAN bracket.
3. Disconnect the antennas from their connectors.
4. Remove the three (M2x5) screws that secure the display cable bracket in place.
5. Remove the display cable bracket from the computer.
6. Disconnect the touch screen cable (for models shipped with a touch screen) or IR camera cable (for models that are shipped with an IR camera) and display cable from their connectors on the system board.
7. Open the display assembly to a 180-degree angle and place the computer at the edge of a flat table so that the display assembly can extend below the table.

NOTE: For computers shipped with IR camera configuration, disconnect the display cable and IR camera cable.

8. Remove the six (M2.5x5) screws that secure the hinges to the palm rest.
9. Remove the display assembly from the palm rest.

NOTE: The display assembly for Precision 7780 is a Hinge-Up Design (HUD) assembly and cannot be further disassembled once it is removed from the bottom chassis. If any components in the display assembly are malfunctioning and must be replaced, replace the entire display assembly.

Installing the display assembly

Prerequisites

If you are replacing a component, remove the existing component before performing the installation procedure.

About this task

The figure indicates the location of the display assembly and provides a visual representation of the installation procedure.

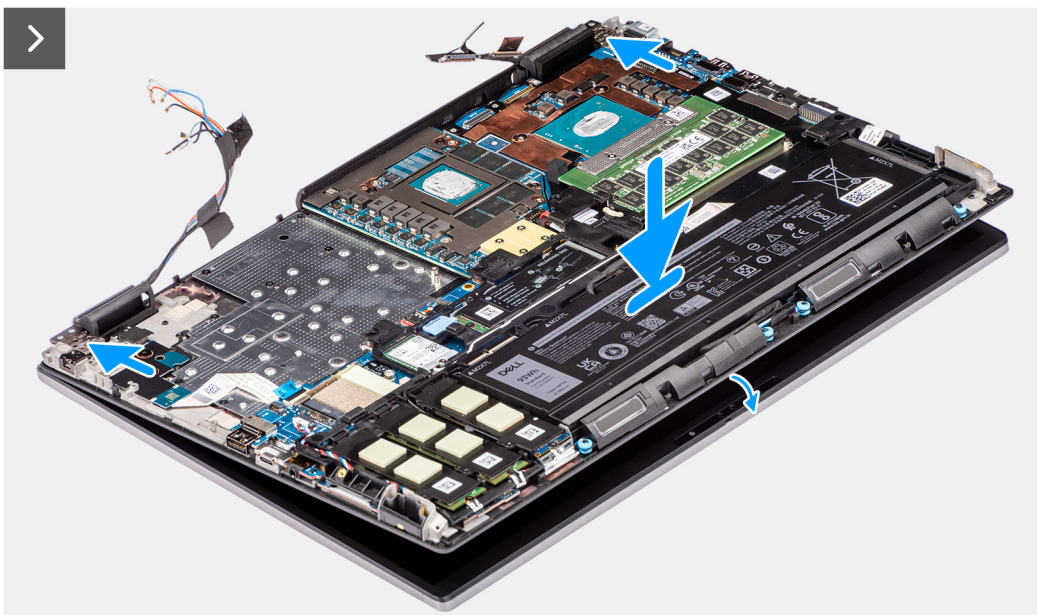

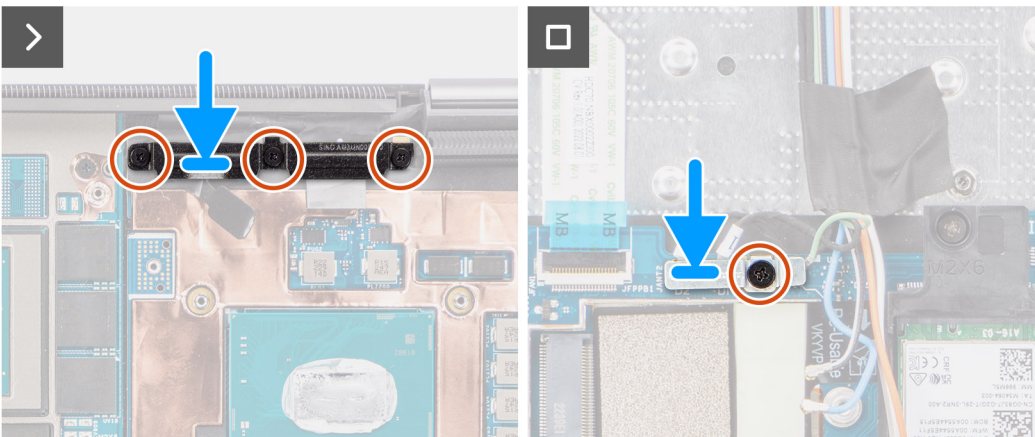
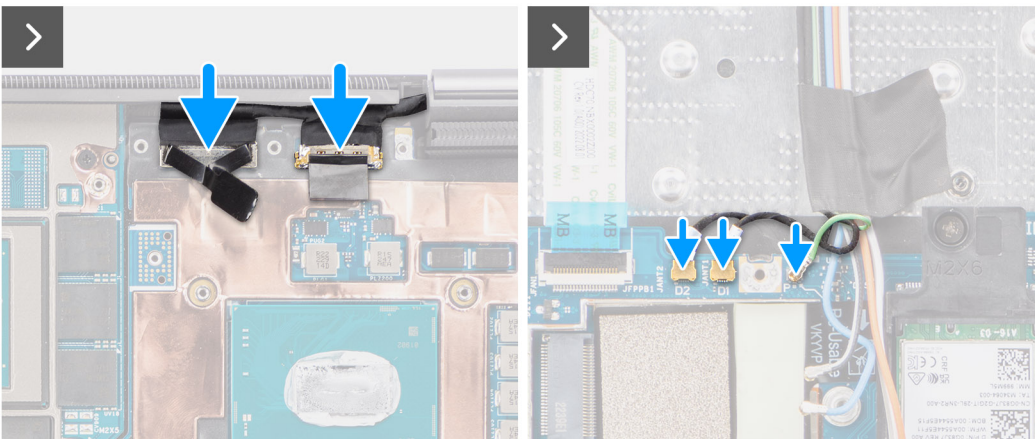
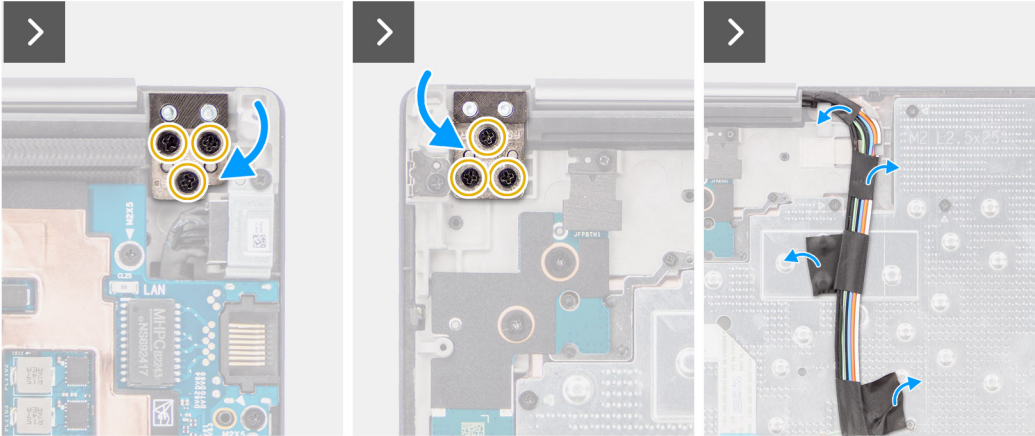
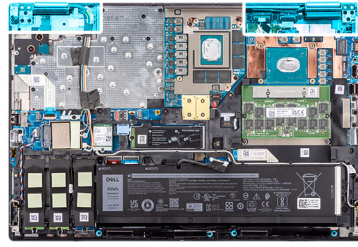

Steps

1. **NOTE:** Before installing the display assembly, ensure that the display hinges are opened to a 90-degree angle against the display assembly, to fit the display assembly to the palm rest.

Align the screw holes on the hinges on the display assembly to the screw holes on the palm rest.

2. Replace the six (M2.5x5) screws to secure the hinges to the palm rest.

3. Connect the touch screen cable (for models shipped with a touch screen) or IR camera cable (for models that are shipped with an IR camera) and display cable to their connectors on the system board.
4. Replace the display cable bracket from the computer.
5. Replace the three (M2x5) screws to secure the display cable bracket in place.
6. Connect the antennas to their connectors.
7. Align the WLAN bracket and replace the (M2x5) screw to secure it to the system board.

Next steps

1. Install the [inner frame](#).
2. Install the [heat-sink for discrete graphics](#).
3. Install the [secondary solid-state drive](#).
4. Install the [primary solid-state drive](#).
5. Install the [WWAN card](#).
6. Install the [interposer board module](#).
7. Install the [CAMM module](#) or [memory module](#).
8. Install the [battery](#).
9. Install the [SIM card](#).
10. Install the [base cover](#).
11. Follow the procedure in [after working inside your computer](#).

Power-adapter port

Removing the power-adapter port

Prerequisites

1. Follow the procedure in [before working inside your computer](#).
2. Remove the [base cover](#).
3. Remove the [SIM card](#).
4. Remove the [battery](#).
5. Remove the [CAMM module](#) or [memory module](#).
6. Remove the [interposer board module](#).
7. Remove the [WWAN card](#).
8. Remove the [primary solid-state drive](#).
9. Remove the [secondary solid-state drive](#).
10. Remove the [heat-sink for discrete graphics](#).
11. Remove the [inner frame](#).
12. Remove the [system board](#).

About this task

The figure indicates the location of the power-adapter port and provides a visual representation of the removal procedure.



1x
M2x3

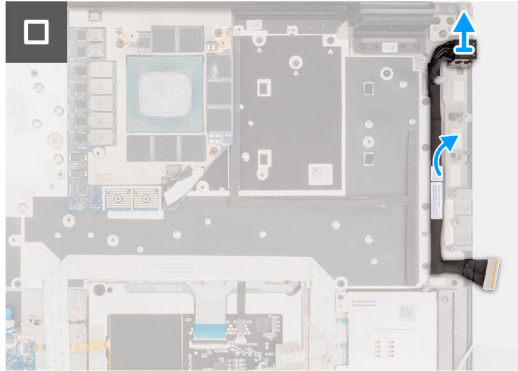
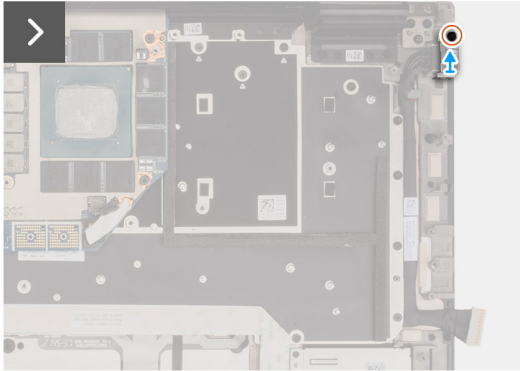
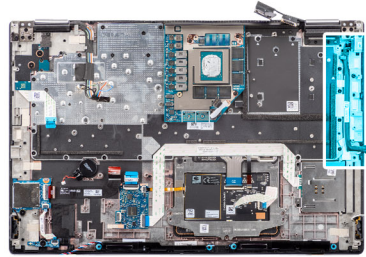

Steps

1. Remove the (M2x3) screw that secures power-adapter port bracket.
2. Disconnect the power-adapter cable from the connector on the system board.
3. Remove the power-adapter port bracket from the computer.
4. Unroute the power-adapter cable from the routing guide on the computer chassis.

Installing the power-adapter port

Prerequisites

If you are replacing a component, remove the existing component before performing the installation procedure.

About this task

The figure indicates the location of the power-adapter port and provides a visual representation of the installation procedure.



1x
M2x3

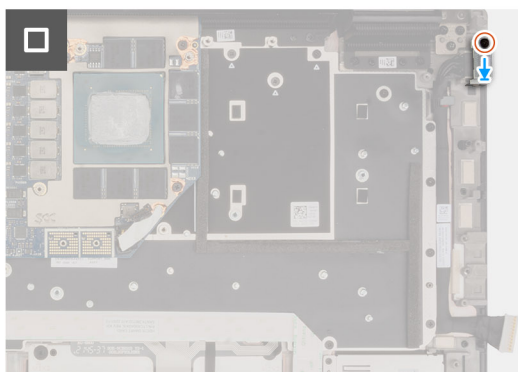
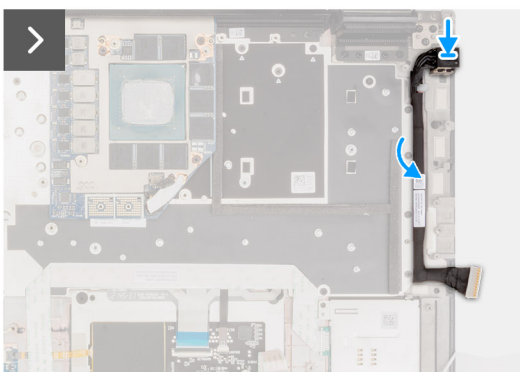
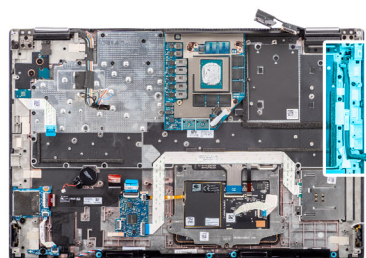

Steps

1. Connect the power-adapter cable to the connector on the system board.
2. Place the power-adapter port bracket on the power-adapter port.
3. Replace the (M2x3) screw to secure the power-adapter port bracket to the computer.
4. Adhere and route the power-adapter cable using the routing guides on the computer chassis.

Next steps

1. Install the [system board](#).
2. Install the [inner frame](#).
3. Install the [heat-sink for discrete graphics](#).
4. Install the [secondary solid-state drive](#).
5. Install the [primary solid-state drive](#).
6. Install the [WWAN card](#).
7. Install the [interposer board module](#).
8. Install the [CAMM module](#) or [memory module](#).
9. Install the [battery](#).
10. Install the [SIM card](#).
11. Install the [base cover](#).
12. Follow the procedure in [after working inside your computer](#).

Smart-card reader

Removing the smart-card reader

Prerequisites

1. Follow the procedure in [before working inside your computer](#).
2. Remove the [base cover](#).
3. Remove the [SIM card](#).
4. Remove the [battery](#).
5. Remove the [CAMM module](#) or [memory module](#).
6. Remove the [interposer board module](#).
7. Remove the [WWAN card](#).
8. Remove the [primary solid-state drive](#).
9. Remove the [secondary solid-state drive](#).
10. Remove the [heat-sink for discrete graphics](#).
11. Remove the [inner frame](#).

About this task

The figure indicates the location of the smart-card reader and provides a visual representation of the removal procedure.



2x
M2x2

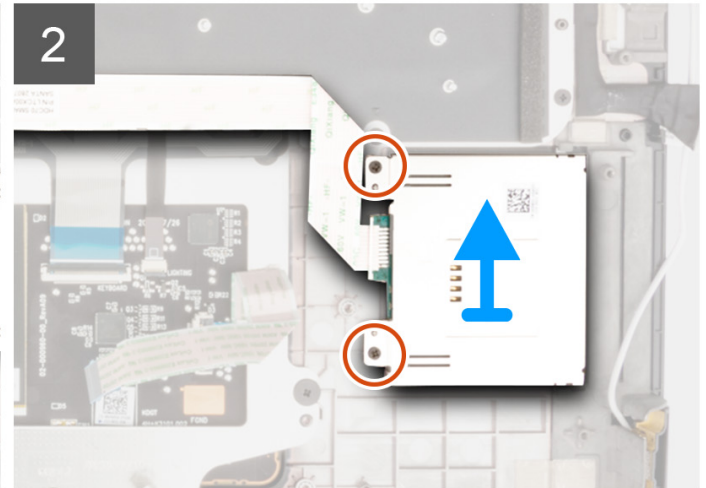
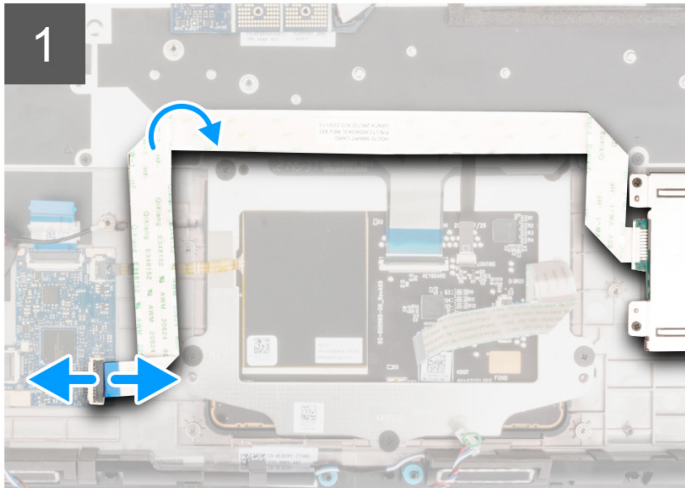
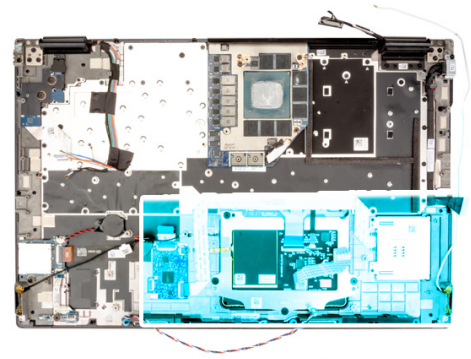

Steps

1. Disconnect the smart-card reader FFC from the connector on the USH daughter board.
2. Peel the smart-card reader FFC from the touchpad.
3. Remove the two (M2x2) screws that secure the smart-card reader to the computer.
4. Remove the smart-card reader from the computer.

Installing the smart-card reader

Prerequisites

If you are replacing a component, remove the existing component before performing the installation procedure.

About this task

The figure indicates the location of the smart-card reader and provides a visual representation of the installation procedure.



2x
M2x2

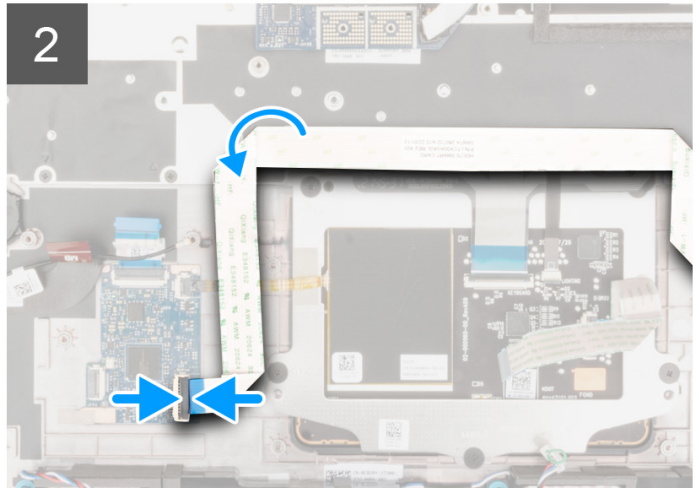
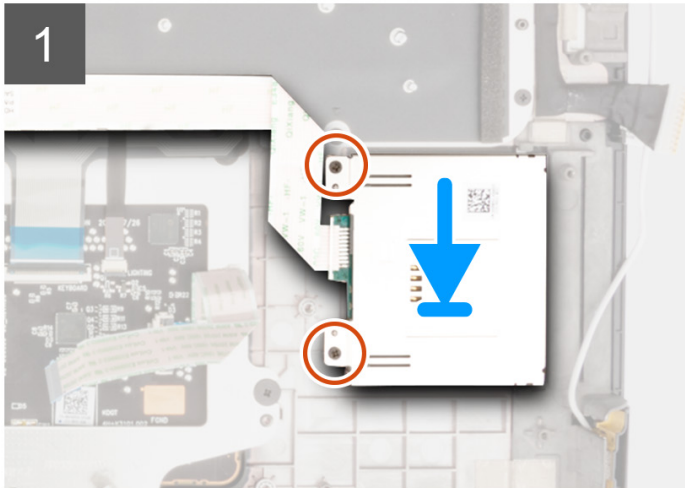
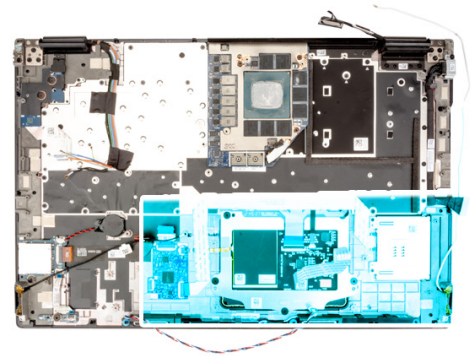

Steps

1. Align and place the smart-card reader into its slot on the computer.
2. Replace the two (M2x2) screws to secure the smart-card reader in place.
3. Adhere the smart-card reader FFC to the touchpad.
4. Connect the smart-card reader FFC to the connector on the USH daughter board.

Next steps

1. Install the [inner frame](#).
2. Install the [heat-sink for discrete graphics](#).
3. Install the [secondary solid-state drive](#).
4. Install the [primary solid-state drive](#).
5. Install the [WWAN card](#).
6. Install the [interposer board module](#).
7. Install the [CAMM module](#) or [memory module](#).
8. Install the [battery](#).
9. Install the [SIM card](#).
10. Install the [base cover](#).
11. Follow the procedure in [after working inside your computer](#).

Keyboard

Removing the keyboard

Prerequisites

1. Follow the procedure in [before working inside your computer](#).
2. Remove the [base cover](#).

3. Remove the SIM card.
4. Remove the battery.
5. Remove the CAMM module or memory module.
6. Remove the interposer board module.
7. Remove the WWAN card.
8. Remove the primary solid-state drive.
9. Remove the secondary solid-state drive.
10. Remove the heat-sink for discrete graphics.
11. Remove the inner frame.
12. Remove the system board.

About this task

The figure indicates the location of the keyboard and provides a visual representation of the removal procedure.

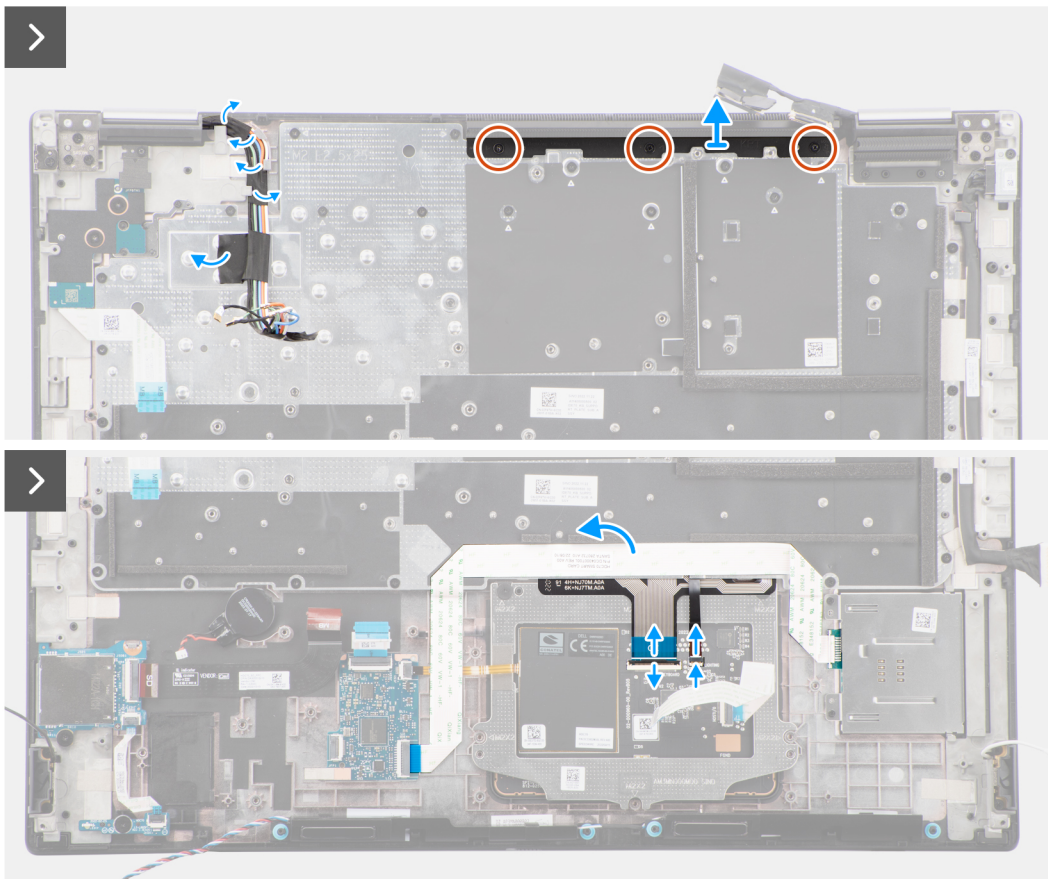
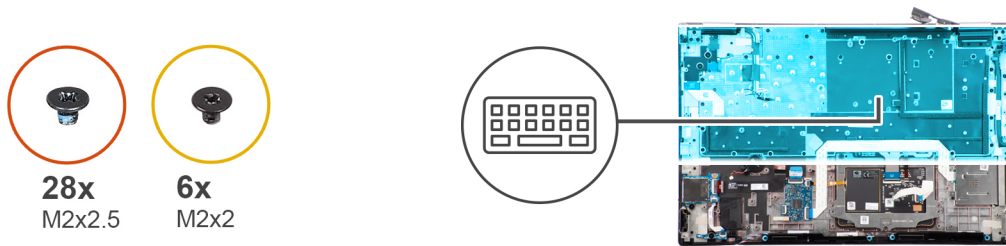

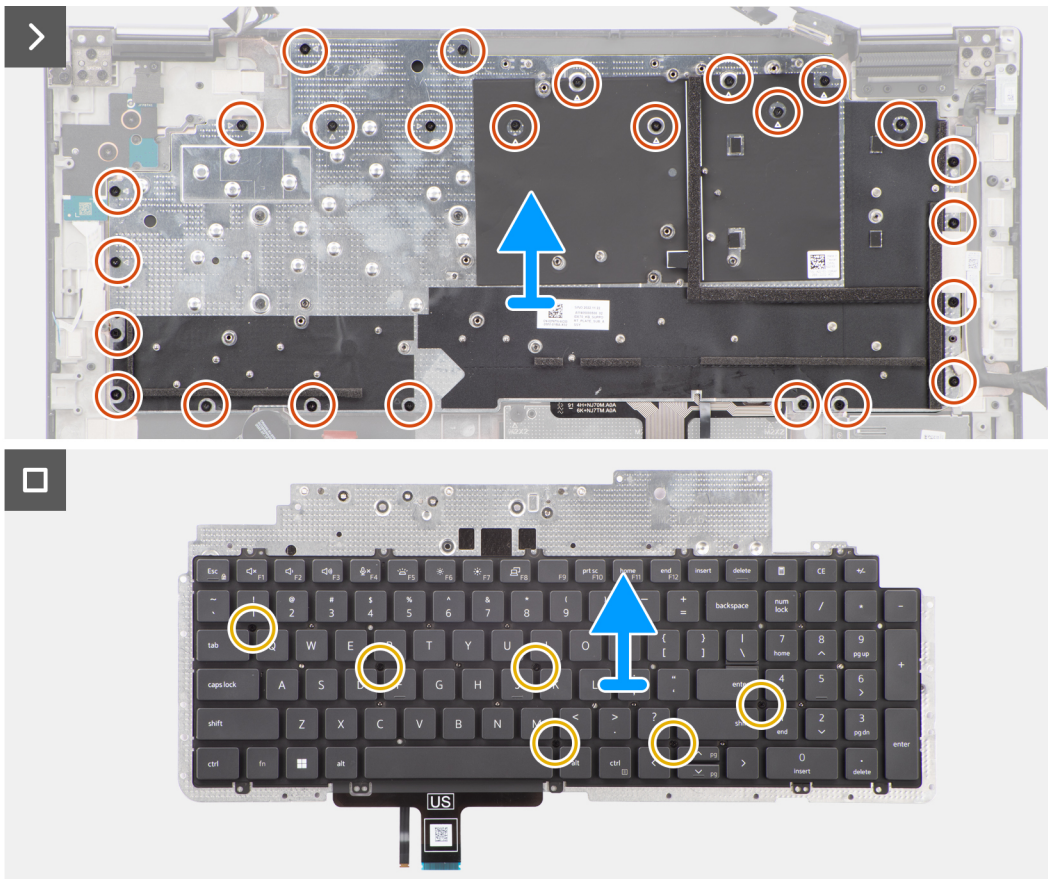

Steps

1. Lift the latch and disconnect the keyboard FPC and the keyboard backlight FPC from the connectors on the touchpad module.

i **NOTE:** For models shipped with a keyboard backlight.

2. **i** **NOTE:** For Precision 7780, remove the three (M2x2.5) screws securing the dummy fin in place and remove the fin before removing the keyboard assembly.

Remove the three (M2x2.5) screws that secure the dummy fin to the palm rest.

3. Remove the 25 (M2x2.5) screws that secure the keyboard support place to the palm rest.

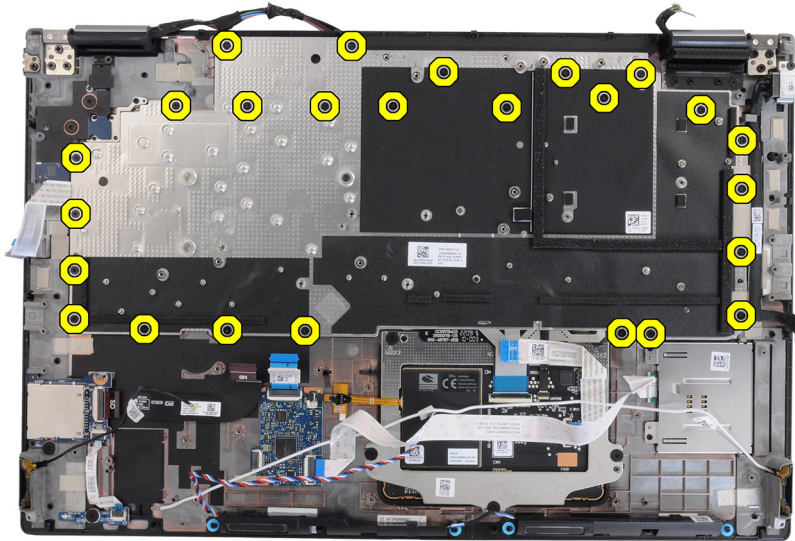

4. Turn-over and open the system at 90° angle.
5. Remove the keyboard and keyboard support plate from the system.
6. Remove the six (M2x2) screws that secure the keyboard to the computer chassis.
7. Remove the keyboard from the keyboard support plate.

Installing the keyboard

Prerequisites

If you are replacing a component, remove the existing component before performing the installation procedure.

About this task

The figure indicates the location of the keyboard and provides a visual representation of the installation procedure.



28x
M2x2.5



6x
M2x2

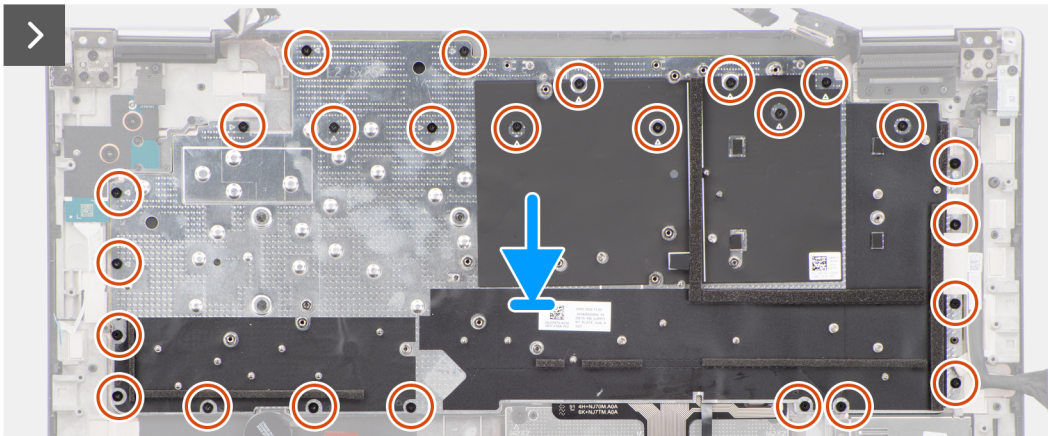
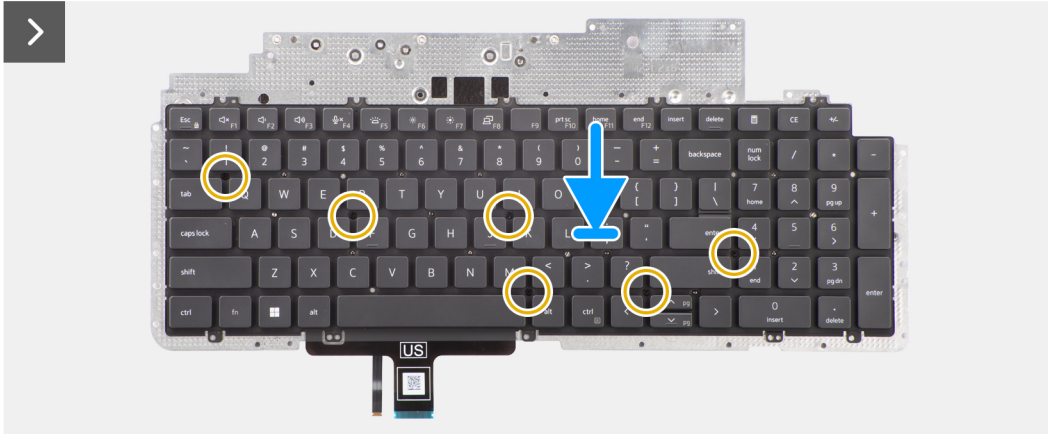
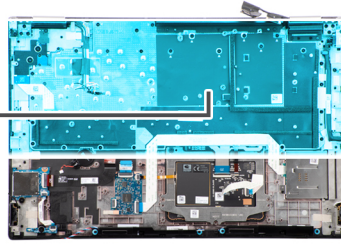

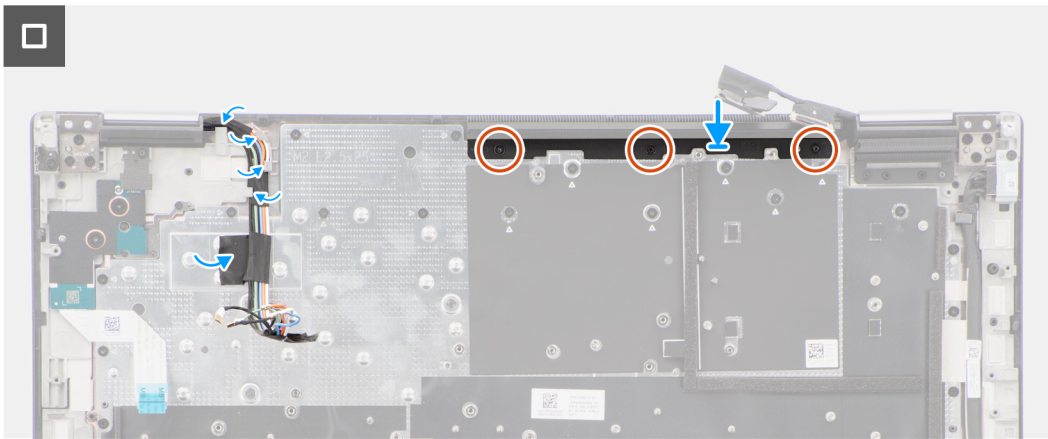
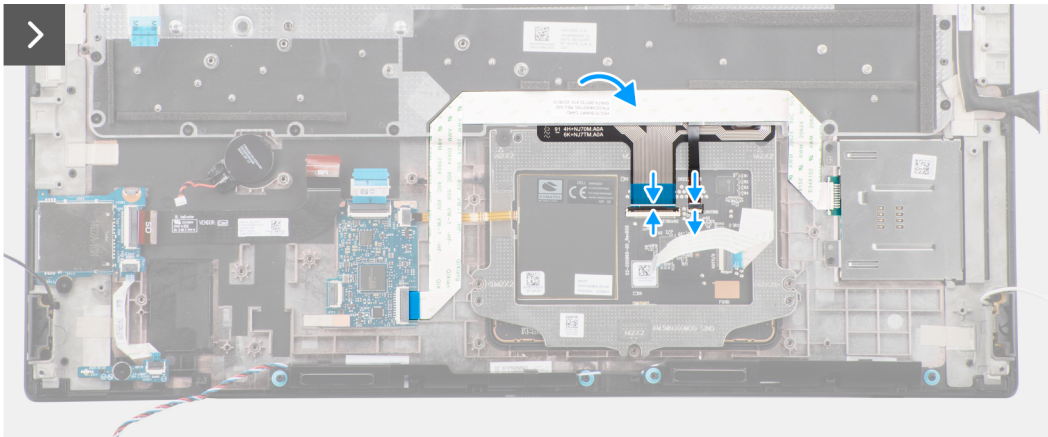

Steps

1. Align the tabs on the keyboard with the tabs on the computer chassis at an angle.
2. Replace the six (M2x2) screws that secure the keyboard to the computer chassis.
3. Replace the 25 (M2x2.5) screws that secure the keyboard support plate to the palm rest.
4. Turn-over the system at 90° angle to, access the keyboard FPC and the keyboard backlight FPC.
5. Lift the latch and connect the keyboard FPC and the keyboard backlight FPC to their connectors on the touchpad module.

NOTE: For models shipped with a keyboard backlight.

6. Replace the three (M2x2.5) screws to secure the dummy fin to the palm rest.

Next steps

1. Install the [system board](#).
2. Install the [inner frame](#).
3. Install the [heat-sink for discrete graphics](#).
4. Install the [secondary solid-state drive](#).
5. Install the [primary solid-state drive](#).
6. Install the [WWAN card](#).
7. Install the [interposer board module](#).
8. Install the [CAMM module](#) or [memory module](#).
9. Install the [battery](#).
10. Install the [SIM card](#).
11. Install the [base cover](#).
12. Follow the procedure in [after working inside your computer](#).

Palm rest

Removing the palm rest

Prerequisites

1. Follow the procedure in [before working inside your computer](#).
2. Remove the [base cover](#).
3. Remove the [SIM card](#).
4. Remove the [battery](#).
5. Remove the [CAMM module](#) or [memory module](#).
6. Remove the [interposer board module](#).
7. Remove the [WWAN card](#).
8. Remove the [primary solid-state drive](#).
9. Remove the [secondary solid-state drive](#).
10. Remove the [heat-sink for discrete graphics](#).
11. Remove the [GPU card](#).
12. Remove the [GPU power cable](#).
13. Remove the [power-button board](#).
14. Remove the [power-button](#).
15. Remove the [speakers](#).
16. Remove the [inner frame](#).
17. Remove the [SD card reader](#).
18. Remove the [system board](#).
19. Remove the [coin-cell battery](#).
20. Remove the [display assembly](#).
21. Remove the [power-adaptor port](#).
22. Remove the [smart card reader](#).
23. Remove the [keyboard](#).

About this task

The figure below shows the palm rest after performing the pre-removal parts procedures for any palm rest replacement.



2x
M2x2.5

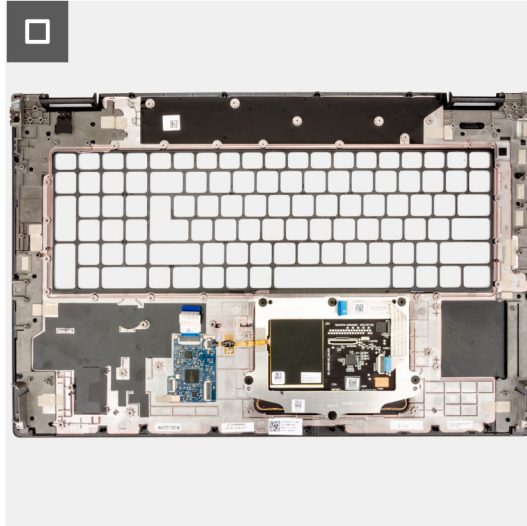
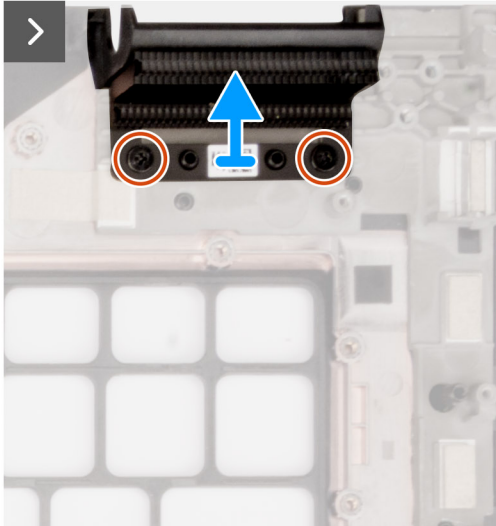
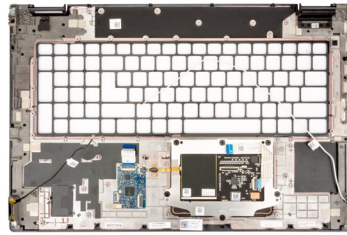

Steps

1. Remove the two (M2x2.5) screws that secure the right dummy fin in place.
2. Remove the right dummy fin from the system.

Installing the palm rest

Prerequisites

If you are replacing a component, remove the existing component before performing the installation procedure.

About this task

The figure indicates the palm rest and before performing the preinstallation parts procedures for any palm rest installation procedure.



2x
M2x2.5

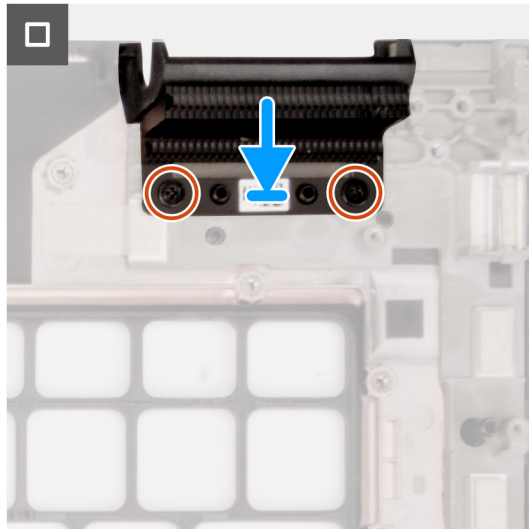
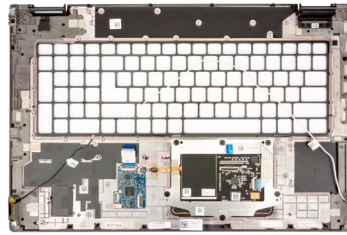

Steps

1. Align the right dummy fin to its slot on the palm rest.
2. Replace the two (M2x2.5) screws to secure the right dummy fin.

Next steps

1. Install the [keyboard](#).
2. Install the [smart card reader](#).
3. Install the [power-adapter port](#).
4. Install the [display assembly](#).
5. Install the [coin-cell battery](#).
6. Install the [system board](#).
7. Install the [SD card reader](#).
8. Install the [inner frame](#).
9. Install the [speakers](#).
10. Install the [power-button](#).
11. Install the [power-button board](#).
12. Install the [GPU power cable](#).
13. Install the [GPU card](#).
14. Install the [heat-sink for discrete graphics](#).
15. Install the [secondary solid-state drive](#).
16. Install the [primary solid-state drive](#).
17. Install the [WWAN card](#).
18. Install the [interposer board module](#).
19. Install the [CAMM module](#) or [memory module](#).
20. Install the [battery](#).
21. Install the [SIM card](#).
22. Install the [base cover](#).
23. Follow the procedure in [after working inside your computer](#).

Drivers and downloads

When troubleshooting, downloading or installing drivers it is recommended that you read the Dell Knowledge Base article, Drivers and Downloads FAQ [000123347](#).

BIOS setup

CAUTION: Unless you are an expert computer user, do not change the settings in the BIOS Setup program. Certain changes can make your computer work incorrectly.

NOTE: Depending on the computer and its installed devices, the items listed in this section may or may not be displayed.

NOTE: Before you change BIOS Setup program, it is recommended that you write down the BIOS Setup program screen information for future reference.

Use the BIOS Setup program for the following purposes:

- Get information about the hardware installed in your computer, such as the amount of RAM and the size of the hard drive.
- Change the system configuration information.
- Set or change a user-selectable option, such as the user password, type of hard drive installed, and enabling or disabling base devices.

Entering BIOS setup program

About this task

Turn on (or restart) your computer and press F2 immediately.

Navigation keys

NOTE: For most of the System Setup options, changes that you make are recorded but do not take effect until you restart the system.

Table 5. Navigation keys

Keys	Navigation
Up arrow	Moves to the previous field.
Down arrow	Moves to the next field.
Enter	Selects a value in the selected field (if applicable) or follow the link in the field.
Spacebar	Expands or collapses a drop-down list, if applicable.
Tab	Moves to the next focus area. NOTE: For the standard graphics browser only.
Esc	Moves to the previous page until you view the main screen. Pressing Esc in the main screen displays a message that prompts you to save any unsaved changes and restarts the system.

One time boot menu

To enter **one time boot menu**, turn on your computer, and then press F2 immediately.

NOTE: It is recommended to shutdown the computer if it is on.

The one-time boot menu displays the devices that you can boot from including the diagnostic option. The boot menu options are:

- Removable Drive (if available)
- STXXXX Drive (if available)
- **i** **NOTE:** XXX denotes the SATA drive number.
- Optical Drive (if available)
- SATA Hard Drive (if available)
- Diagnostics
- **i** **NOTE:** Choosing **Diagnostics**, will display the **ePSA diagnostics** screen.

The boot sequence screen also displays the option to access the System Setup screen.

BIOS setup options

i **NOTE:** Depending on this computer and its installed devices, the items that are listed in this section may or may not appear.

Table 6. BIOS setup options—System information menu

General-System Information	
System Information	
BIOS Version	Displays the BIOS version number.
Service Tag	Displays the Service Tag of the computer.
Asset Tag	Displays the Asset Tag of the computer.
Manufacturing Date	Displays the manufacture date of the computer.
Ownership Date	Displays the ownership date of the computer.
Express Service Code	Displays the express service code of the computer.
Ownership Tag	Displays the ownership tag of the computer.
Signed Firmware update	Displays the signed firmware update status of the computer.
Battery Information	
Primary	Displays the primary battery of the computer.
Battery Level	Displays the battery level of the computer.
Battery State	Displays the battery state of the computer.
Health	Displays the battery health of the computer.
AC Adapter	Displays the AC adapter information of the computer.
Battery Life Type	Displays the battery life type of the computer.
Processor Information	
Processor Type	Displays the processor type.
Maximum Clock Speed	Displays the maximum processor clock speed.
Minimum Clock Speed	Displays the minimum processor clock speed.
Current Clock Speed	Displays the current processor clock speed.
Core Count	Displays the number of cores on the processor.
Processor ID	Displays the processor identification code.
Processor L2 Cache	Displays the Processor L2 cache size, unit is KB.
Processor L3 Cache	Displays the Processor L3 cache size, unit is KB.
Microcode version	Displays the microcode version.

Table 6. BIOS setup options—System information menu (continued)

General-System Information	
Intel Hyper-Threading Capable	Displays whether the processor is HyperThreading (HT) capable.
64-Bit Technology	Displays whether 64-bit technology is used.
Memory Information	
Memory Installed	Displays the total computer memory installed.
Memory Available	Displays the total computer memory available.
Memory Speed	Displays the memory speed.
Memory Channel Mode	Displays single or dual channel mode.
Memory Technology	Displays the technology that is used for the memory.
DIMM Slot A	Displays the DIMM slot A CAMM memory size.
Device Information	
Panel Type	Displays the Panel Type of the computer.
Video Controller	Displays the video controller type of the computer.
Video Memory	Displays the video memory information of the computer.
Wi-Fi Device	Displays the wireless device information of the computer.
Native Resolution	Displays the native resolution of the computer.
Video BIOS Version	Displays the video BIOS version of the computer.
Audio Controller	Displays the audio controller information of the computer.
Bluetooth Device	Displays the bluetooth device information of the computer.
LOM MAC Address	Displays the LOM MAC address of the computer.
Passthrough MAC Address	Displays the unique MAC address information of the computer.
Cellular Device	Displays the cellular device information of the computer.
dGPU Video Controller	Displays the discrete graphics information of the computer.

Table 7. System setup options—Boot Configuration menu

Boot Configuration	
Boot Sequence	
Boot mode	Displays the boot mode.
Boot Sequence	Displays the boot sequence.
Secure Digital (SD) Card Boot	Enable or disable the SD card read-only boot. By default, the Secure Digital (SD) Card Boot option is not enabled.
Secure Boot	
Enable Secure Boot	Enable or disable the secure boot feature. By default, the option is not enabled.
Enable Microsoft UEFI CA	Enable or disable the UEFI secure boot feature. By default, the option is enabled.
Secure Boot Mode	Enable or disable to change the secure boot mode options. By default, the Deployed Mode is enabled.
Expert Key Management	
Enable Custom Mode	Enable or disable custom mode.

Table 7. System setup options—Boot Configuration menu (continued)

Boot Configuration	
	By default, the custom mode option is not enabled.
Custom Mode Key Management	Select the custom values for expert key management.

Table 8. System setup options—Integrated Devices menu

Integrated Devices	
Date/Time	Displays the current date in MM/DD/YYYY format and current time in HH:MM:SS AM/PM format.
Memory Mapped I/O above 4 Gig	Enable or disable the Memory Mapped I/O above 4 GB. By default, the ON option is selected
Camera	Enable or disable the camera. By default, the Enable Camera option is selected
Audio Enable Audio	Enable or disable the integrated audio controller. By default, all the options are enabled.
USB/Thunderbolt Configuration	<ul style="list-style-type: none"> • Enable or disable booting from USB mass storage devices that are connected to external USB ports. By default, the Enable External USB Ports option is enabled. • Enable or disable booting from USB mass storage devices such as external hard drive, optical drive, and USB drive. By default, the Enable USB Boot Support option is enabled.
Enable Thunderbolt Technology Support	Enable or disable the associated ports and adapters. By default, the Enable Thunderbolt Technology Support option is selected.
Enable Thunderbolt Boot Support	Enable or disable the Thunderbolt adapter-peripheral device and USB devices that are connected to the Thunderbolt adapter to be used during BIOS Pre-boot. By default, the Enable Thunderbolt Boot Support option is disabled.
Enable Thunderbolt (and PCIe behind TBT) pre-boot modules	Enable or disable the PCIe devices that are connected through a Thunderbolt adapter to run the PCIe devices UEFI Option ROM (if present) during pre-boot. By default, the Enable Thunderbolt (and PCIe behind TBT) pre-boot modules option is disabled.
Disable USB4 PCIe Tunneling	Disable the USB4 PCIe Tunneling option. By default, the option is disabled.
Video/Power only on Type-C Ports	Enable or disable the Type-C port functionality to video or only power. By default, the Video/Power only on Type-C Ports option is disabled.
Type-C Dock Override	Enable to use connected Type-C Dell Dock to provide data stream with external USB ports disabled. When Type-C Dock Override is enabled, the Video/Audio/Lan submenu is activated. By default, the Type-C Dock Override option is enabled.
Type-C Dock Audio	Enable or disable the usage of audio on Dell Dock external ports. By default, the Audio option is enabled.
Type-C Dock Lan	Enable or disable the usage of LAN on Dell Dock external ports.

Table 8. System setup options—Integrated Devices menu (continued)

Integrated Devices	
	By default, the Lan option is enabled.
Miscellaneous Devices	Enable or disable Fingerprint Reader device. By default, the Enable Fingerprint Reader Device option is enabled.
Unobtrusive Mode	When the feature is enabled, it turns off all system light and sound. By default, the option is disabled.

Table 9. System setup options—Storage menu

Storage	
SATA/NVMe Operation	
SATA/NVMe Operation	Set the operating mode of the integrated storage device controller. By default, the RAID On option is enabled.
Storage interface	
Port Enablement	This page allows you to enable the onboard drives. By default, the M.2 PCIe SSD-0 , M.2 PCIe SSD-1 , M.2 PCIe SSD-2 , and M.2 PCIe SSD-3 options are enabled.
SMART Reporting	
Enable SMART Reporting	Enable or disable Self-Monitoring, Analysis, and Reporting Technology (SMART) during system startup. By default, the Enable SMART Reporting option is not enabled.
Drive Information	
M.2 PCIe SSD	
Type	Displays the M.2 PCIe SSD-0 type information of the system.
Device	Displays the M.2 PCIe SSD-0 device information of the system.
Type	Displays the M.2 PCIe SSD-1 type information of the system.
Device	Displays the M.2 PCIe SSD-1 device information of the system.
Type	Displays the M.2 PCIe SSD-2 type information of the system.
Device	Displays the M.2 PCIe SSD-2 device information of the system.
Type	Displays the M.2 PCIe SSD-3 type information of the system.
Device	Displays the M.2 PCIe SSD-3 device information of the system.
Enable MediaCard	
Secure Digital (SD) Card	Enable or disable the SD card. By default, the Secure Digital (SD) Card option is enabled.
Secure Digital (SD) Card Read-Only Mode	Enable or disable the SD card read-only mode. By default, the Secure Digital (SD) Card Read-Only Mode option is disabled.

Table 10. System setup options—Display menu

Display	
Display Brightness	
Brightness on battery power	Enable to set screen brightness when the system is running on battery power.

Table 10. System setup options—Display menu (continued)

Display	
Brightness on AC power	Enable to set screen brightness when the system is running on AC power.
Touchscreen	
Touchscreen	Enable or disable the touch screen for the operating system. By default, the option is enabled.
Full Screen Logo	
	Enable or disable full screen logo. By default, the option is disabled.
Hybrid Graphics	
Enable Hybrid Graphics	Enable or disable the Enable Hybrid Graphics. By default, the option is enabled.
Direct Graphics Controller Direct Output Mode	Enable or disable the Direct Graphics Controller Direct Output Mode. By default, the option is disabled.

Table 11. System setup options—Connection menu

Connection	
Network Controller Configuration	
Integrated NIC	Enable or disable the on-board LAN controller. By default, the Enabled with PXE option enabled.
Wireless Device Enable	
WWAN/GPS	Enable or disable the internal WWAN/GPS device. By default, the option enabled.
WLAN	Enable or disable the internal WLAN device. By default, the option enabled.
Bluetooth	Enable or disable the internal Bluetooth device By default, the option enabled.
Contactless smartcard/NFC	Enable or disable the internal Contactless smartcard/NFC device By default, the option enabled.
Enable UEFI Network Stack	
	Enable or disable UEFI Network Stack and controls the on-board LAN Controller. By default, the Auto enabled option is selected.
Wireless Radio Control	
Control WLAN radio	Sense the connection of the system to a wired network and later disable the selected wireless radios (WLAN). By default, the option is disabled.
Control WWAN radio	Sense the connection of the system to a wired network and later disable the selected wireless radios (WWAN). By default, the option is disabled.
Dynamic Wireless Transmit Power	
	Enable or disable the Dynamic Wireless Transmit Power of WLAN device. By default, the Dynamic Wireless Transmit Power option is selected.
HTTPs Boot Feature	
HTTPs Boot	Enable or disable the HTTPs Boot feature.

Table 11. System setup options—Connection menu (continued)

Connection	
HTTPs Boot Mode	<p>By default, the ON option is enabled.</p> <p>With Auto Mode, the HTTPs Boot extracts Boot URL from the DHCP. With Manual Mode, the HTTPs Boot reads Boot URL from the user-provided data.</p> <p>By default, the Auto Mode option is enabled.</p>

Table 12. System setup options—Power menu

Power	
<p>Battery Configuration</p>	<p>Enables the system to run on battery during peak power usage hours. Use the table Custom Charge Start and Custom Charge Stop to prevent AC power usage between certain times of each day.</p> <p>By default, the Adaptive option is enabled.</p>
<p>Advanced Configuration</p> <p>Enable Advanced Battery Charge Configuration</p>	<p>Enable or disable the advanced battery charge configuration.</p> <p>By default, the Enable Advanced Battery Charge Configuration option is disabled.</p>
<p>Peak Shift</p> <p>Enable Peak Shift</p>	<p>Enables the system to run on battery during peak power usage hours.</p> <p>By default, the Enable Peak Shift option is disabled.</p>
<p>USB PowerShare</p> <p>Enable USB PowerShare</p>	<p>Enables the charging of external devices using the stored system battery.</p> <p>By default, the Enable USB PowerShare option is disabled.</p>
<p>Thermal Management</p>	<p>Enables to cool the fan and processor heat management to adjust the system performance, noise, and temperature.</p> <p>By default, the Optimized option is enabled.</p>
<p>USB Wake Support</p> <p>Wake on Dell USB-C Dock</p>	<p>When enabled, connecting a Dell USB-C Dock will wake the system from Standby, Hibernate, and Power Off.</p> <p>By default, the Wake on Dell USB-C Dock option is enabled.</p>
<p>Block Sleep</p>	<p>Enable to block entering Sleep (S3) mode in the operating system.</p> <p>By default, the Block Sleep option is disabled.</p>
<p>Lid Switch</p> <p>Power On Lid Open</p>	<p>When enabled, allows the system to power up from the off state whenever the lid is opened.</p> <p>By default, the Power On Lid Open option is disabled.</p>
<p>Intel Speed Shift Technology</p>	<p>Enable or disable the Intel Speed Shift Technology support.</p> <p>By default, the Intel Speed Shift Technology option is enabled.</p>

Table 13. System setup options—Security menu

Security	
<p>Intel Platform Trust Technology</p> <p>Intel Platform Trust Technology On</p>	<p>Allows you to enable or disable Intel Platform Trust Technology visibility to operating system.</p> <p>By default, the Intel Platform Trust Technology On option is enabled.</p>

Table 13. System setup options—Security menu (continued)

Security	
Clear	<p>Enable to clear the TPM owner information and returns the TPM to the default state.</p> <p>By default, the Clear option is disabled.</p>
Intel Total Memory Encryption	
Mutli-Key Total Memory Encryption (Up to 16 keys)	<p>Enable or disable you to protect memory from physical attacks including freeze spray, probing DDR to read the cycles, and others.</p> <p>By default, the Total Memory Encryption option is disabled.</p>
Chassis intrusion	
	<p>Controls the chassis intrusion feature.</p> <p>By default, the disabled option is enabled.</p>
Clear intrusion warning	<p>By default, the option is disabled.</p>
SMM Security Mitigation	
	<p>Enable or disable additional UEFI SMM Security Mitigation protections.</p> <p>By default, the option is enabled.</p>
Data Wipe on Next Boot	
Start Data Wipe	<p>Enable or disable the data wipe on next boot.</p> <p>By default, the Start Data Wipe option is disabled.</p>
Absolute	<p>Enable, disable, or permanently disable the BIOS module interface of the optional Absolute Persistence Module service from Absolute Software.</p> <p>By default, the option is enabled.</p> <p>⚠ WARNING: The 'Permanently Disabled' option can only be selected once. When 'Permanently Disabled' is selected, Absolute Persistence cannot be re-enabled. No further changes to the Enable/Disable states are allowed.</p> <p>i NOTE: The Enable/Disable options are unavailable while Computrace is in the activated state.</p>
UEFI Boot Path Security	<p>Controls whether the system prompts the user to enter the admin password (if set) when booting to a UEFI boot path device from the F12 boot menu.</p> <p>By default, the Always Except Internal HDD option is enabled.</p>
Firmware Device Tamper Detection	
Firmware Device Tamper Detection	<p>By default, the Silent option is enabled.</p>
Clear Firmware Device Tamper Detection	<p>By default, the option is disabled.</p>

Table 14. System setup options—Passwords menu

Passwords	
Admin Password	Set, change, or delete the administrator password.
System Password	Set, change, or delete the system password.
M.2 PCIe SSD-0	Set, change, or delete the NVMe SSD-0 password.
M.2 PCIe SSD-3	Set, change, or delete the NVMe SSD-3 password.
Password Configuration	
Upper Case Letter	<p>Reinforces password must have at least one upper case letter.</p> <p>By default, the option is disabled.</p>
Lower Case Letter	<p>Reinforces password must have at least one lower case letter.</p>

Table 14. System setup options—Passwords menu (continued)

Passwords	
Digit	<p>By default, the option is disabled.</p> <p>Reinforces password must have at least one digit number.</p> <p>By default, the option is disabled.</p>
Special Character	<p>Reinforces password must have at least one special character.</p> <p>By default, the option is disabled.</p>
Minimum Characters	<p>Set the minimum characters allowed for password.</p>
Password Bypass	<p>When enabled, this always prompts for system and internal hard drive passwords when powered on from the Off state.</p> <p>By default, the Disabled option is selected.</p>
Password Changes	
Allow Non-Admin Password Changes	<p>Enable or disable to change system and hard drive password without the need for admin password.</p> <p>By default, the option is enabled.</p>
Admin Setup Lockout	
Enable Admin Setup Lockout	<p>Enables administrators control over how their users can or cannot access BIOS setup.</p> <p>By default, the option is disabled.</p>
Master Password Lockout	
Enable Master Password Lockout	<p>When enabled, this disables the master password support.</p> <p>By default, the option is disabled.</p>
Allow Non-Admin PSID Revert	
Enable Allow Non-Admin PSID Revert	<p>Controls access to the Physical Security ID (PSID) revert of NVMe hard-drives from the Dell Security Manager prompt.</p> <p>By default, the option is disabled.</p>

Table 15. System setup options—Update, Recovery menu

Update, Recovery	
UEFI Capsule Firmware Updates	<p>Enable or disable BIOS updates through UEFI capsule update packages.</p> <p>i NOTE: Disabling this option blocks BIOS updates from services such as Microsoft Windows Update and Linux Vendor Firmware Service (LVFS).</p> <p>By default, the option is enabled.</p>
BIOS Recovery from Hard Drive	<p>Enables the user to recover from certain corrupted BIOS conditions from a recovery file on the user primary hard drive or an external USB key.</p> <p>By default, the option is enabled.</p> <p>i NOTE: BIOS Recovery from Hard Drive is not available for self-encrypting drives (SED).</p>
BIOS Downgrade	
Allow BIOS Downgrade	<p>This field controls the flashing of the system firmware to previous revisions.</p> <p>By default, the option is enabled.</p>
SupportAssist OS Recovery	<p>Enable or disable the boot flow for SupportAssist OS Recovery tool in the event of certain system errors.</p>

Table 15. System setup options—Update, Recovery menu (continued)

Update, Recovery	
BIOSConnect	<p>By default, the option is enabled.</p> <p>Enable or disable cloud Service operating system recovery if the main operating system fails to boot with the number of failures equal to or greater than the value specified by the Auto operating system Recovery Threshold setup option and local Service operating system does not boot or is not installed.</p> <p>By default, the option is enabled.</p>
Dell Auto operating system Recovery Threshold	<p>Controls the automatic boot flow for SupportAssist System Resolution Console and for Dell operating system Recovery Tool.</p> <p>By default, the threshold value is set to 2.</p>

Table 16. System setup options—System Management menu

System Management	
Service Tag	Displays the Service Tag of the system.
Asset Tag	Create a system Asset Tag.
AC Behavior	
Wake on AC	<p>Enable or disable the wake on AC option.</p> <p>By default, the option is disabled.</p>
Wake on LAN	
Wake on LAN	<p>Enable or disable the system to power on by special LAN signals when it receives a wakeup signal from the WLAN.</p> <p>By default, the Disabled option is selected.</p>
Auto on Time	<p>Enable to set the system to turn on automatically every day or on a preselected date and time. This option can be configured only if the Auto On Time is set to Everyday, Weekdays, or Selected Days.</p> <p>By default, the option is disabled.</p>
Intel AMT Capability	
Enable Intel AMT Capability	By default Restrict Preboot Access option is enabled.
Diagnostics	
Operating system Agent Requests	By default operating system Agent Requests option is enabled.
Power-on-Self-Test Automatic Recovery	
Power-on-Self-Test Automatic Recovery	By default Power-on-Self-Test Automatic Recovery option is enabled.

Table 17. System setup options—Keyboard menu

Keyboard	
Numlock Options	By default, the Numlock option is enabled.
Fn Lock Options	By default, the Fn lock option is enabled.
Lock Mode	By default, the Lock Mode Secondary option is enabled. With this option, the F1-F2 keys scan the code for their secondary functions.
Keyboard Illumination	<p>Enable to change the keyboard illumination settings.</p> <p>By default, the Dim option is enabled.</p>
Keyboard Backlight Timeout on AC	Set the timeout value for the keyboard backlight when an AC adapter is connected to the system.

Table 17. System setup options—Keyboard menu (continued)

Keyboard	
	By default, the 10 seconds option is enabled.
Keyboard Backlight Timeout on Battery	Set the timeout value for the keyboard backlight when the is running only on battery power. By default, the 10 seconds option is enabled.
Device Configuration Hotkey Access	Manages whether you can access device configuration screens through hotkeys during system startup. By default, the option is enabled.

Table 18. System setup options—Pre-boot Behavior menu

Pre-boot Behavior	
Adapter Warnings	
Enable Adapter Warnings	Enable or disable the warning messages during boot when the adapters with less power capacity are detected. By default, the option is enabled.
Warning and Errors	Enable or disable the action to be done when a warning or error is encountered. By default, the Prompt on Warnings and Errors option is enabled.
Fastboot	Allows you to configure the speed of the UEFI boot process. By default, the Minimal option is enabled.
Extend BIOS POST Time	Set the BIOS POST load time. By default, the 0 seconds option is enabled.
MAC Address Pass-Through	Replaces the external NIC MAC address with the selected MAC address from the system. By default, the Passthrough MAC Address option is enabled.

Table 19. System setup options—Virtualization menu

Virtualization	
Intel Virtualization Technology	
Enable Intel Virtualization Technology (VT)	When enabled, the system can run a Virtual Machine Monitor (VMM). By default, the option is enabled.
VT for Direct I/O	When enabled, the system can perform Virtualization Technology for Direct I/O (VT-d). By default, the option is enabled.
DMA Protection	
Enable Pre-Boot DMA Support	This setting controls Pre-boot DMA protection for both internal and external ports. By default, the option is enabled.
Enable operating system Kernel DMA Support	This setting controls Kernel DMA protection for both internal and external ports. By default, the option is enabled.

Table 20. System setup options—Performance menu

Performance	
Multi Core Support	
Active Cores	Enables to change the number of CPU cores available to the operating system. By default, the All Cores option is enabled.
Multiple Atom Cores	Enables to change the number of Atom cores available to the operating system. By default, the All Cores option is enabled.
Intel SpeedStep	
Enable Intel SpeedStep Technology	Enables the system to dynamically adjust processor voltage and core frequency, decreasing average power consumption and heat production. By default, the option is enabled.
C-States Control	
Enable C-State Control	Enables the ability of the CPU to enter and exit low power state. When disabled, it disabled all C-states. When enabled, it enabled all C-states that the chipset or platform allows. By default, the option is enabled.
Enable Adaptive C-States for Discrete Graphics	Enables the ability of the CPU to dynamically detect high usage of a discrete graphic and adjust system parameters for higher performance. By default, the option is enabled.
Intel Turbo Boost Technology	
Enable Intel Turbo Boost Technology	Enable or disable the Intel TurboBoost mode of the processor. By default, the option is enabled.
Intel Turbo Boost Maximum Technology 3.0	
Enable Intel Turbo Boost Maximum Technology 3.0	Enable or disable the Intel TurboBoost maximum mode of the processor. By default, the option is disabled.
Intel Hyper-Threading Technology	
Enable Intel Hyper-Threading Technology	Enable or disable Hyper-Threading in the processor. By default, the option is enabled.
PCIe Resizeable Base Address Register (BAR)	
	Platform considers to Enable this option, if there is no compatibility issue with supported graphics card. By default, the option is disabled.

Table 21. System setup options—System Logs menu

System Logs	
BIOS Event Log	
Clear Bios Event Log	Displays BIOS events. By default, the Keep Log option is enabled.
Thermal Event Log	
Clear Thermal Event Log	Displays Thermal events. By default, the Keep Log option is enabled.
Power Event Log	
Clear Power Event Log	Displays power events.

Table 21. System setup options—System Logs menu (continued)

System Logs	
	By default, the Keep Log option is enabled.

Table 22. System setup options—About

About	
License Information	Displays the license information of the system.

Clearing chassis intrusion alert

The system features a chassis intrusion switch which can detect anytime the base cover has been removed from the system. Alerts to notify you of any intrusions can be enabled using the **Chassis Intrusion** field in the **Security** submenu of the BIOS setup menu.

When enabled, the **Block Boot Until Cleared** field allows you to choose whether to prevent normal boot up of the system until the intrusion alert is cleared.

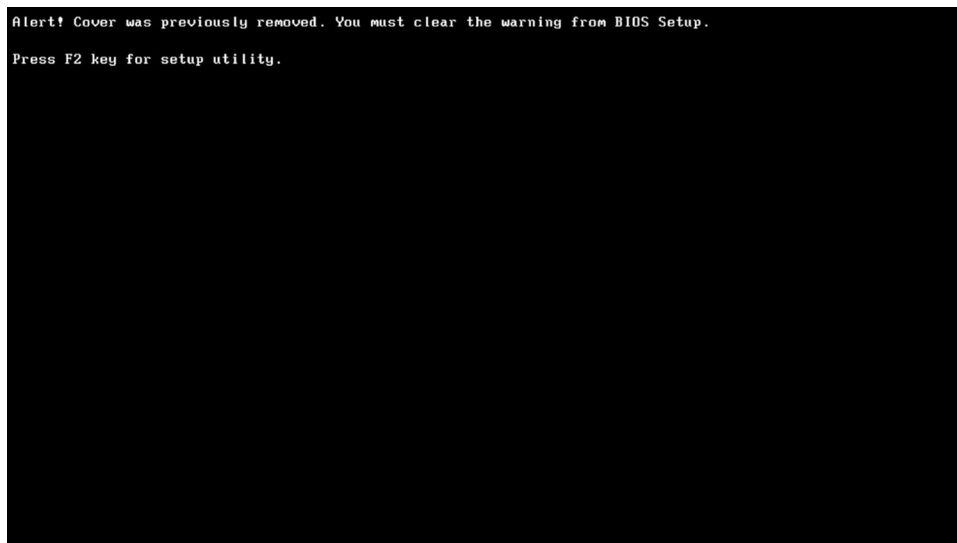
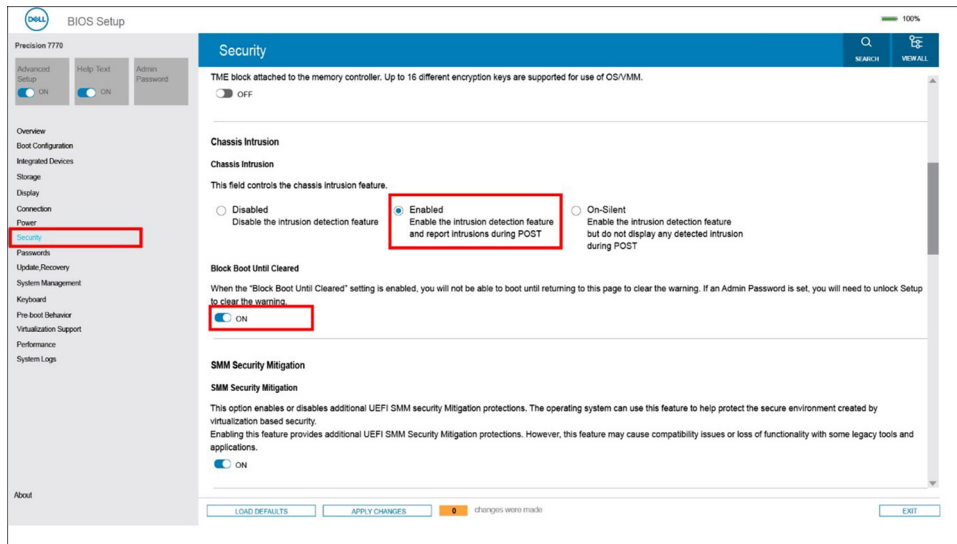

If **Block Boot Until Cleared** is set to **OFF**, select **Continue** to boot normally or **BIOS-Setup** to clear the alert.

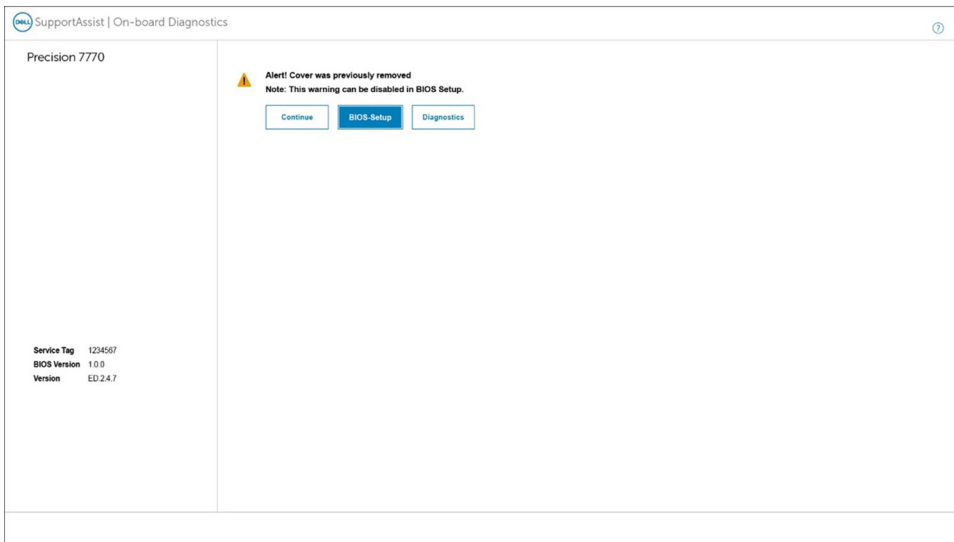

NOTE: If **Continue** is selected, the user continues to see the alert each time the system is powered on until the alert is cleared.

To clear the alert, select **ON** in the **Clear Intrusion Warning** field in the **Security** submenu of the BIOS setup menu.

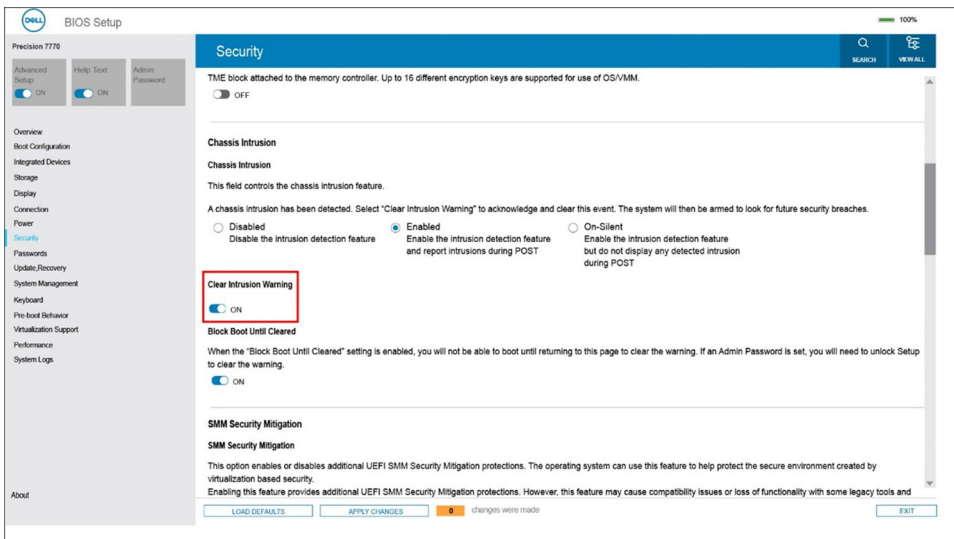

Updating the BIOS

Updating the BIOS in Windows

About this task

CAUTION: If BitLocker is not suspended before updating the BIOS, the next time you reboot the system it will not recognize the BitLocker key. You will then be prompted to enter the recovery key to progress and the system will ask for this on each reboot. If the recovery key is not known this can result in data loss or an unnecessary operating system re-install. For more information on this subject, search in the Knowledge Base Resource at www.dell.com/support.

Steps

1. Go to www.dell.com/support.
2. Click **Product support**. In the **Search support** box, enter the Service Tag of your computer, and then click **Search**.

 **NOTE:** If you do not have the Service Tag, use the SupportAssist feature to automatically identify your computer. You can also use the product ID or manually browse for your computer model.

3. Click **Drivers & Downloads**. Expand **Find drivers**.
4. Select the operating system installed on your computer.
5. In the **Category** drop-down list, select **BIOS**.
6. Select the latest version of BIOS, and click **Download** to download the BIOS file for your computer.
7. After the download is complete, browse the folder where you saved the BIOS update file.
8. Double-click the BIOS update file icon and follow the on-screen instructions.

For more information, search in the Knowledge Base Resource at www.dell.com/support.

Updating the BIOS in Linux and Ubuntu

To update the system BIOS on a computer that is installed with Linux or Ubuntu, see the knowledge base article [000131486](https://www.dell.com/support) at www.dell.com/support.

Updating the BIOS using the USB drive in Windows

About this task

 **CAUTION:** If BitLocker is not suspended before updating the BIOS, the next time you reboot the system it will not recognize the BitLocker key. You will then be prompted to enter the recovery key to progress and the system will ask for this on each reboot. If the recovery key is not known this can result in data loss or an unnecessary operating system re-install. For more information on this subject, search in the Knowledge Base Resource at www.dell.com/support.

Steps

1. Follow the procedure from step 1 to step 6 in [Updating the BIOS in Windows](#) to download the latest BIOS setup program file.
2. Create a bootable USB drive. For more information, search in the Knowledge Base Resource at www.dell.com/support.
3. Copy the BIOS setup program file to the bootable USB drive.
4. Connect the bootable USB drive to the computer that needs the BIOS update.
5. Restart the computer and press **F12**.
6. Select the USB drive from the **One Time Boot Menu**.
7. Type the BIOS setup program filename and press **Enter**.
The **BIOS Update Utility** appears.
8. Follow the on-screen instructions to complete the BIOS update.

Updating the BIOS from the F12 One-Time boot menu

Update your computer BIOS using the BIOS update.exe file that is copied to a FAT32 USB drive and booting from the F12 One-Time boot menu.

About this task

 **CAUTION:** If BitLocker is not suspended before updating the BIOS, the next time you reboot the system it will not recognize the BitLocker key. You will then be prompted to enter the recovery key to progress and the system will ask for this on each reboot. If the recovery key is not known this can result in data loss or an unnecessary operating system re-install. For more information on this subject, search in the Knowledge Base Resource at www.dell.com/support.

BIOS Update

You can run the BIOS update file from Windows using a bootable USB drive or you can also update the BIOS from the F12 One-Time boot menu on the computer.

Most of the Dell computers built after 2012 have this capability, and you can confirm by booting your computer to the F12 One-Time Boot Menu to see if BIOS FLASH UPDATE is listed as a boot option for your computer. If the option is listed, then the BIOS supports this BIOS update option.

 **NOTE:** Only computers with BIOS Flash Update option in the F12 One-Time boot menu can use this function.

Updating from the One-Time boot menu

To update your BIOS from the F12 One-Time boot menu, you need the following:

- USB drive formatted to the FAT32 file system (key does not have to be bootable)
- BIOS executable file that you downloaded from the Dell Support website and copied to the root of the USB drive
- AC power adapter that is connected to the computer
- Functional computer battery to flash the BIOS

Perform the following steps to perform the BIOS update flash process from the F12 menu:

 **CAUTION:** Do not turn off the computer during the BIOS update process. The computer may not boot if you turn off your computer.

Steps

1. From a turn off state, insert the USB drive where you copied the flash into a USB port of the computer.
2. Turn on the computer and press F12 to access the One-Time Boot Menu, select BIOS Update using the mouse or arrow keys then press Enter.
The flash BIOS menu is displayed.
3. Click **Flash from file**.
4. Select external USB device.
5. Select the file and double-click the flash target file, and then click **Submit**.
6. Click **Update BIOS**. The computer restarts to flash the BIOS.
7. The computer will restart after the BIOS update is completed.

System and setup password

Table 23. System and setup password

Password type	Description
System password	Password that you must enter to log in to your system.
Setup password	Password that you must enter to access and make changes to the BIOS settings of your computer.

You can create a system password and a setup password to secure your computer.

 **CAUTION:** The password features provide a basic level of security for the data on your computer.

 **CAUTION:** Anyone can access the data that is stored on your computer if it is not locked and left unattended.

 **NOTE:** System and setup password feature is disabled.

Assigning a system setup password

Prerequisites

You can assign a new **System or Admin Password** only when the status is in **Not Set**.

About this task

To enter the system setup, press F12 immediately after a power-on or reboot.

Steps

1. In the **System BIOS** or **System Setup** screen, select **Security** and press Enter.
The **Security** screen is displayed.
2. Select **System/Admin Password** and create a password in the **Enter the new password** field.
Use the following guidelines to assign the system password:
 - A password can have up to 32 characters.
 - At least one special character: ! " # \$ % & ' () * + , - . / : ; < = > ? @ [\] ^ _ ` { | }
 - Numbers 0 through 9.
 - Upper case letters from A to Z.
 - Lower case letters from a to z.
3. Type the system password that you entered earlier in the **Confirm new password** field and click **OK**.
4. Press Esc and save the changes as prompted by the pop-up message.
5. Press Y to save the changes.
The computer restarts.

Deleting or changing an existing system setup password

Prerequisites

Ensure that the **Password Status** is Unlocked (in the System Setup) before attempting to delete or change the existing System and/or Setup password. You cannot delete or change an existing System or Setup password, if the **Password Status** is Locked.

About this task

To enter the System Setup, press F12 immediately after a power-on or reboot.

Steps

1. In the **System BIOS** or **System Setup** screen, select **System Security** and press Enter.
The **System Security** screen is displayed.
2. In the **System Security** screen, verify that **Password Status** is **Unlocked**.
3. Select **System Password**, update, or delete the existing system password, and press Enter or Tab.
4. Select **Setup Password**, update, or delete the existing setup password, and press Enter or Tab.
 **NOTE:** If you change the System and/or Setup password, reenter the new password when prompted. If you delete the System and/or Setup password, confirm the deletion when prompted.
5. Press Esc and a message prompts you to save the changes.
6. Press Y to save the changes and exit from System Setup.
The computer restarts.

Clearing CMOS settings

About this task

 **CAUTION:** Clearing CMOS settings resets the BIOS settings on your computer.

Steps

1. Remove the [base cover](#).
2. Disconnect the battery cable from the system board.
3. Remove the [coin-cell battery](#).
4. Wait for one minute.
5. Replace the [coin-cell battery](#).
6. Connect the battery cable to the system board.

7. Replace the [base cover](#).

Clearing BIOS (System Setup) and System passwords

About this task

To clear the system or BIOS passwords, contact Dell technical support as described at www.dell.com/contactdell.

 **NOTE:** For information on how to reset Windows or application passwords, refer to the documentation accompanying Windows or your application.

Troubleshooting

Handling swollen rechargeable Li-ion batteries

Like most laptops, Dell laptops use Lithium-ion batteries. One type of Lithium-ion battery is the rechargeable Li-ion battery. Rechargeable Li-ion batteries have increased in popularity in recent years and have become standard in the electronics industry due to customer preferences for a slim form factor (especially with newer ultra-thin laptops) and long battery life. Inherent to rechargeable Li-ion battery technology is the potential for swelling of the battery cells.

Swollen battery may impact the performance of the laptop. To prevent possible further damage to the device enclosure or internal components leading to malfunction, discontinue the use of the laptop and discharge it by disconnecting the AC adapter and letting the battery drain.

Swollen batteries should not be used and should be replaced and disposed of properly. We recommend contacting Dell product support for options to replace a swollen battery under the terms of the applicable warranty or service contract, including options for replacement by a Dell authorized service technician.

The guidelines for handling and replacing rechargeable Li-ion batteries are as follows:

- Exercise caution when handling rechargeable Li-ion batteries.
- Discharge the battery before removing it from the system. To discharge the battery, unplug the AC adapter from the system and operate the system only on battery power. When the system will no longer power on when the power button is pressed, the battery is fully discharged.
- Do not crush, drop, mutilate, or penetrate the battery with foreign objects.
- Do not expose the battery to high temperatures, or disassemble battery packs and cells.
- Do not apply pressure to the surface of the battery.
- Do not bend the battery.
- Do not use tools of any type to pry on or against the battery.
- If a battery gets stuck in a device as a result of swelling, do not try to free it as puncturing, bending, or crushing a battery can be dangerous.
- Do not attempt to reassemble a damaged or swollen battery into a laptop.
- Swollen batteries that are covered under warranty should be returned to Dell in an approved shipping container (provided by Dell)—this is to comply with transportation regulations. Swollen batteries that are not covered under warranty should be disposed of at an approved recycling center. Contact Dell product support at <https://www.dell.com/support> for assistance and further instructions.
- Using a non-Dell or incompatible battery may increase the risk of fire or explosion. Replace the battery only with a compatible battery purchased from Dell that is designed to work with your Dell computer. Do not use a battery from other computers with your computer. Always purchase genuine batteries from <https://www.dell.com> or otherwise directly from Dell.

Rechargeable Li-ion batteries can swell for various reasons such as age, number of charge cycles, or exposure to high heat. For more information on how to improve the performance and lifespan of the laptop battery and to minimize the possibility of occurrence of the issue, search Dell Laptop Battery in the Knowledge Base Resource at www.dell.com/support.

Dell SupportAssist Pre-boot System Performance Check diagnostics

About this task

SupportAssist diagnostics (also known as system diagnostics) performs a complete check of your hardware. The Dell SupportAssist Pre-boot System Performance Check diagnostics is embedded with the BIOS and is launched by the BIOS internally. The embedded system diagnostics provides a set of options for particular devices or device groups allowing you to:

- Run tests automatically or in an interactive mode
- Repeat tests
- Display or save test results

- Run thorough tests to introduce additional test options to provide extra information about the failed device(s)
- View status messages that inform you if tests are completed successfully
- View error messages that inform you of problems encountered during testing

NOTE: Some tests for specific devices require user interaction. Always ensure that you are present at the computer terminal when the diagnostic tests are performed.

For more information, see <https://www.dell.com/support/kbdoc/000180971>.

Running the SupportAssist Pre-Boot System Performance Check

Steps

1. Turn on your computer.
2. As the computer boots, press the F12 key as the Dell logo appears.
3. On the boot menu screen, select the **Diagnostics** option.
4. Click the arrow at the bottom left corner.
Diagnostics front page is displayed.
5. Click the arrow in the lower-right corner to go to the page listing.
The items detected are listed.
6. To run a diagnostic test on a specific device, press Esc and click **Yes** to stop the diagnostic test.
7. Select the device from the left pane and click **Run Tests**.
8. If there are any issues, error codes are displayed.
Note the error code and validation number and contact Dell.

Built-in self-test (BIST)

M-BIST

M-BIST (Built In Self-Test) is the system board's built-in self-test diagnostics tool that improves the diagnostics accuracy of system board embedded controller (EC) failures.

NOTE: M-BIST can be manually initiated before POST (Power On Self Test).

How to run M-BIST

NOTE: M-BIST must be initiated on the system from a power-off state either connected to AC power or with battery only.

1. Press and hold both the **M** key on the keyboard and the **power button** to initiate M-BIST.
2. With both the **M** key and the **power button** held down, the battery indicator LED may exhibit two states:
 - a. OFF: No fault detected with the system board
 - b. AMBER: Indicates a problem with the system board
3. If there is a failure with the system board, the battery status LED will flash one of the following error codes for 30 seconds:

Table 24. LED error codes

Blinking Pattern		Possible Problem
Amber	White	
2	1	CPU Failure
2	8	LCD Power Rail Failure
1	1	TPM Detection Failure
2	4	Memory/RAM failure

4. If there is no failure with the system board, the LCD will cycle through the solid color screens described in the LCD-BIST section for 30 seconds and then power off.

LCD Power rail test (L-BIST)

L-BIST is an enhancement to the single LED error code diagnostics and is automatically initiated during POST. L-BIST will check the LCD power rail. If there is no power being supplied to the LCD (that is if the L-BIST circuit fails), the battery status LED will flash either an error code [2,8] or an error code [2,7].

NOTE: If L-BIST fails, LCD-BIST cannot function as no power will be supplied to the LCD.

How to invoke L-BIST Test:

1. Press the power button to start the system.
2. If the system does not start up normally, look at the battery status LED:
 - If the battery status LED flashes an error code [2,7], the display cable may not be connected properly.
 - If the battery status LED flashes an error code [2,8], there is a failure on the LCD power rail of the system board, hence there is no power supplied to the LCD.
3. For cases, when a [2,7] error code is shown, check to see if the display cable is properly connected.
4. For cases when a [2,8] error code is shown, replace the system board.

LCD Built-in Self Test (BIST)

Dell laptops have a built-in diagnostic tool that helps you determine if the screen abnormality you are experiencing is an inherent problem with the LCD (screen) of the Dell laptop or with the video card (GPU) and PC settings.

When you notice screen abnormalities like flickering, distortion, clarity issues, fuzzy or blurry image, horizontal or vertical lines, color fade etc., it is always a good practice to isolate the LCD (screen) by running the Built-In Self Test (BIST).

How to invoke LCD BIST Test

1. Power off the Dell laptop.
2. Disconnect any peripherals that are connected to the laptop. Connect only the AC adapter (charger) to the laptop.
3. Ensure that the LCD (screen) is clean (no dust particles on the surface of the screen).
4. Press and hold **D** key and **Power on** the laptop to enter LCD built-in self test (BIST) mode. Continue to hold the D key, until the system boots up.
5. The screen will display solid colors and change colors on the entire screen to white, black, red, green, and blue twice.
6. Then it will display the colors white, black and red.
7. Carefully inspect the screen for abnormalities (any lines, fuzzy color or distortion on the screen).
8. At the end of the last solid color (red), the system will shut down.

NOTE: Dell SupportAssist Pre-boot diagnostics upon launch, initiates an LCD BIST first, expecting a user intervention confirm functionality of the LCD.

System-diagnostic lights

Table 25. System-diagnostic lights

Blinking pattern		Problem description	Suggested resolution
Amber	White		
1	1	TPM detection failure	Replace the system board.
1	2	Unrecoverable SPI Flash Failure	Replace the system board.
1	3	Short in hinge cable tripped OCP1	
1	4	Short in hinge cable tripped OCP2	

Table 25. System-diagnostic lights (continued)

Blinking pattern		Problem description	Suggested resolution
Amber	White		
1	5	EC unable to program i-Fuse	Replace the system board.
1	6	Generic catch-all for ungraceful EC code flow errors	Disconnect all power source (AC, battery, coin cell) and drain flea power by pressing and holding down power button for 3~5 seconds.
2	1	CPU failure	<ul style="list-style-type: none"> Run the Dell Support Assist/Dell Diagnostics tool. If problem persists, replace the system board.
2	2	System board failure (included BIOS corruption or ROM error)	<ul style="list-style-type: none"> Flash latest BIOS version If problem persists, replace the system board.
2	3	No memory/RAM detected	<ul style="list-style-type: none"> Confirm that the memory module is installed properly. If problem persists, replace the memory module.
2	4	Memory/RAM failure	<ul style="list-style-type: none"> Reset and swap memory modules among the slots. If problem persists, replace the memory module.
2	5	Invalid memory installed	<ul style="list-style-type: none"> Reset and swap memory modules among the slots. If problem persists, replace the memory module.
2	6	System board/Chipset Error	Replace the system board.
2	7	LCD failure (SBIOS message)	Replace the LCD module.
2	8	LCD failure (EC detection of power rail failure)	Replace the system board.
3	1	CMOS battery failure	<ul style="list-style-type: none"> Reset the main battery connection. If problem persists, replace the main battery.
3	2	PCI or Video card/chip failure	Replace the system board.
3	4	BIOS Recovery image found but invalid	<ul style="list-style-type: none"> Flash latest BIOS version If problem persists, replace the system board.
3	5	Power rail failure	Replace the system board.
3	6	Flash corruption detected by SBIOS.	<ul style="list-style-type: none"> Press power button for over 25 seconds to do RTC reset. If problem

Table 25. System-diagnostic lights (continued)

Blinking pattern		Problem description	Suggested resolution
Amber	White		
			<p>persists, replace the system board.</p> <ul style="list-style-type: none"> • Disconnect all power source (AC, battery, coin cell) and drain flea power by pressing and holding down power button 3~5 seconds to ensure all power are drained. • Run "BIOS recovery from USB", and the instructions are in the website Dell support. • If problem persists, replace the system board.
3	7	Timeout waiting on ME to reply to HECI message.	Replace the system board
4	1	Memory DIMM power rail failure	<ul style="list-style-type: none"> • Reset and swap memory modules among the slots. • If problem persists, replace the memory module.
4	2	CPU Power Cable connection issue	<ul style="list-style-type: none"> • Run the PSU BIST. • If problem persists, replace the system board, power supply or cabling.

NOTE: Blinking 3-3-3 LEDs on Lock LED (Caps-Lock or Num-Lock), Power button LED (without Fingerprint reader), and Diagnostic LED indicates failure to provide input during LCD panel test on Dell SupportAssist Pre-boot System Performance Check diagnostics.

Recovering the operating system

When your computer is unable to boot to the operating system even after repeated attempts, it automatically starts Dell SupportAssist OS Recovery.

Dell SupportAssist OS Recovery is a standalone tool that is preinstalled in all Dell computers installed with Windows operating system. It consists of tools to diagnose and troubleshoot issues that may occur before your computer boots to the operating system. It enables you to diagnose hardware issues, repair your computer, back up your files, or restore your computer to its factory state.

You can also download it from the Dell Support website to troubleshoot and fix your computer when it fails to boot into their primary operating system due to software or hardware failures.

For more information about the Dell SupportAssist OS Recovery, see *Dell SupportAssist OS Recovery User's Guide* at www.dell.com/serviceabilitytools. Click **SupportAssist** and then, click **SupportAssist OS Recovery**.

Real-Time Clock (RTC Reset)

The Real Time Clock (RTC) reset function allows you or the service technician to recover Dell systems from No POST/No Power/No Boot situations. The legacy jumper enabled RTC reset has been retired on these models.

Start the RTC reset with the system powered off and connected to AC power. Press and hold the power button for thirty (30) seconds

. The system RTC Reset occurs after you release the power button.

Backup media and recovery options

It is recommended to create a recovery drive to troubleshoot and fix problems that may occur with Windows. Dell proposes multiple options for recovering Windows operating system on your Dell PC. For more information, see [Dell Windows Backup Media and Recovery Options](#).

Wi-Fi power cycle

About this task

If your computer is unable to access the Internet due to Wi-Fi connectivity issues a Wi-Fi power cycle procedure may be performed. The following procedure provides the instructions on how to conduct a Wi-Fi power cycle:

 **NOTE:** Some ISPs (Internet Service Providers) provide a modem/router combo device.

Steps

1. Turn off your computer.
2. Turn off the modem.
3. Turn off the wireless router.
4. Wait for 30 seconds.
5. Turn on the wireless router.
6. Turn on the modem.
7. Turn on your computer.

Drain residual flea power (perform hard reset)

About this task

Flea power is the residual static electricity that remains in the computer even after it has been powered off and the battery is removed.

For your safety, and to protect the sensitive electronic components in your computer, you are requested to drain residual flea power before removing or replacing any components in your computer.

Draining residual flea power, also known as a performing a "hard reset", is also a common troubleshooting step if your computer does not power on or boot into the operating system.

To drain residual flea power (perform a hard reset)

Steps

1. Turn off your computer.
2. Disconnect the power adapter from your computer.
3. Remove the base cover.
4. Remove the battery.
5. Press and hold the power button for 20 seconds to drain the flea power.
6. Install the battery.
7. Install the base cover.
8. Connect the power adapter to your computer.
9. Turn on your computer.

 **NOTE:** For more information about performing a hard reset, search in the Knowledge Base Resource at www.dell.com/support.

Getting help and contacting Dell

Self-help resources

You can get information and help on Dell products and services using these self-help resources:

Table 26. Self-help resources

Self-help resources	Resource location
Information about Dell products and services	www.dell.com
Tips	
Contact Support	In Windows search, type <code>Contact Support</code> , and press Enter.
Online help for operating system	www.dell.com/support/windows www.dell.com/support/linux
Access top solutions, diagnostics, drivers and downloads, and learn more about your computer through videos, manuals and documents.	Your Dell computer is uniquely identified by a Service Tag or Express Service Code. To view relevant support resources for your Dell computer, enter the Service Tag or Express Service Code at www.dell.com/support . For more information on how to find the Service Tag for your computer, see Locate the Service Tag on your computer .
Dell knowledge base articles for a variety of computer concerns	<ol style="list-style-type: none"> 1. Go to www.dell.com/support. 2. On the menu bar at the top of the Support page, select Support > Knowledge Base. 3. In the Search field on the Knowledge Base page, type the keyword, topic, or model number, and then click or tap the search icon to view the related articles.

Contacting Dell

To contact Dell for sales, technical support, or customer service issues, see www.dell.com/contactdell.

 **NOTE:** Availability varies by country/region and product, and some services may not be available in your country/region.

 **NOTE:** If you do not have an active Internet connection, you can find contact information about your purchase invoice, packing slip, bill, or Dell product catalog.