

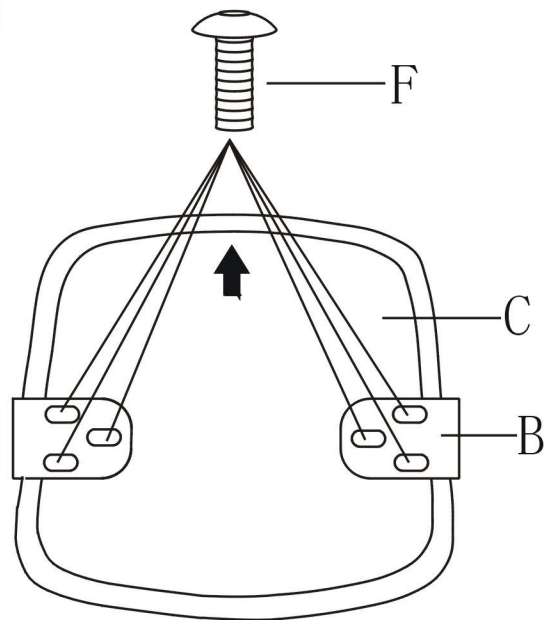
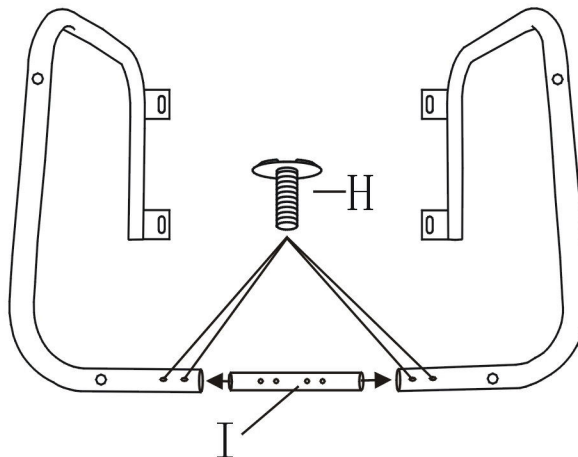
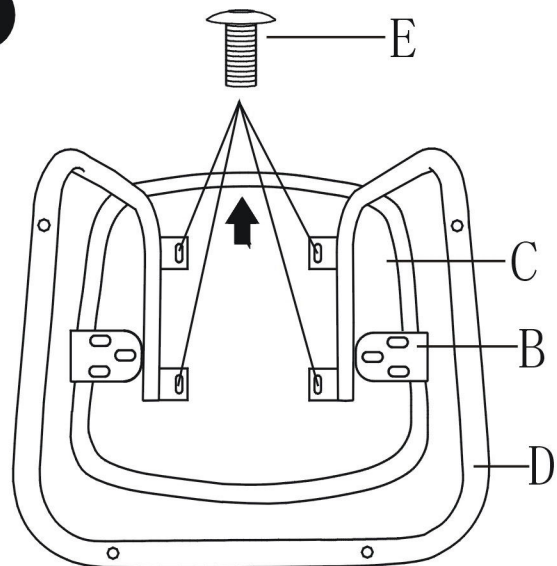
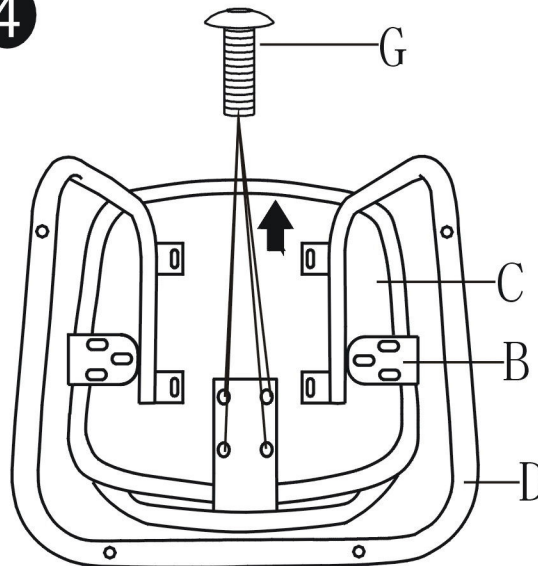
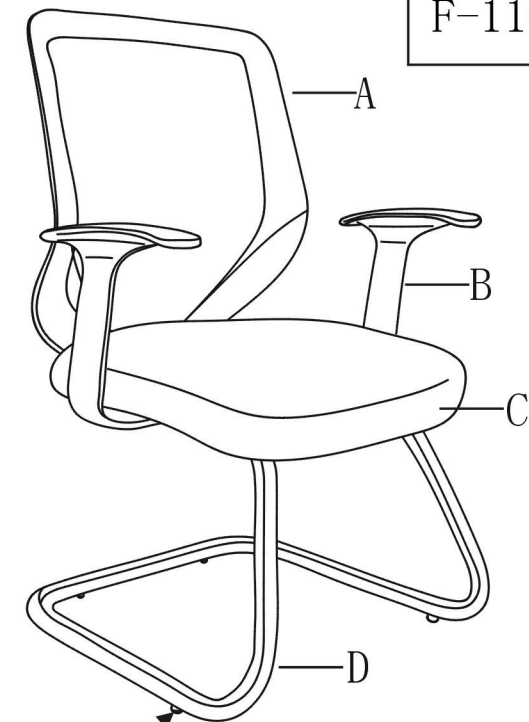

**1****2****3****4****5**

F-1102

REMARK:  
TO ADJUST GRADIENT OF  
THE CHAIR BY FOUR SCREWS.

E   
M6\*20MM /4PCS

G   
M6\*25MM /4PCS

I 

J   
M5 /1PC

F   
M6\*30MM /6PCS

H   
M6\*16MM /4PCS

K   
M4 /1PC